

University of Rajshahi

Rajshahi-6205

Bangladesh.

RUCL Institutional Repository

<http://rulrepository.ru.ac.bd>

Institute of Bangladesh Studies (IBS)

PhD thesis

2021

Employee Motivation and Human Resource Development in the Banking Sector of Bangladesh: Theories and Practices

Rahman, Mohammad Azizur

University of Rajshahi

<http://rulrepository.ru.ac.bd/handle/123456789/1052>

Copyright to the University of Rajshahi. All rights reserved. Downloaded from RUCL Institutional Repository.

**Employee Motivation and Human Resource Development in
the Banking Sector of Bangladesh: Theories and Practices**

PhD Dissertation

Researcher

Mohammad Azizur Rahman



**Institute of Bangladesh Studies
University of Rajshahi, Bangladesh**

January 2021

Employee Motivation and Human Resource Development in the Banking Sector of Bangladesh: Theories and Practices

*A dissertation submitted to the Institute of Bangladesh Studies in partial
fulfilment of the requirements for the degree of Doctor of
Philosophy in Management*

Researcher

Mohammad Azizur Rahman
PhD Researcher, Id No. 1713183905
Session: 2016-2017
Institute of Bangladesh Studies
University of Rajshahi

Supervisor

Dr. Md. Omar Faruk Sarker
Professor
Department of Marketing
University of Rajshahi
Rajshahi, Bangladesh

Co-Supervisor

Dr. Md. Kamruzzaman
Associate Professor
Institute of Bangladesh Studies
University of Rajshahi
Rajshahi, Bangladesh



**Institute of Bangladesh Studies
University of Rajshahi, Bangladesh**

January 2021

Dedication

My dedication revered parents Mohammad Jahed Ali and Anowara Begum, elder brother Md. Jamal Uddin, my spouse Abeda Sultana Angur, beloved two sons Ahnaf Azfar Mugdho and Afif Arshad Munif and respected to all the teachers in my life.

Certificate

We have great pleasure to certify that the dissertation entitled **Employee Motivation and Human Resource Development in the Banking Sector of Bangladesh: Theories and Practices** submitted by Mr. Mohammad Azizur Rahman to the Institute of Bangladesh Studies, University of Rajshahi, Bangladesh for the degree of Doctor of Philosophy in Management is an original research work done under our supervision and guidance respectively. To the best of my knowledge, this dissertation was not previously submitted for any diploma/degree/fellowship to any other University/Institute. Study related materials/ data collected from different sources have been duly acknowledged in this thesis.

Dr. Md. Omar Faruk Sarker
Supervisor
&
Professor
Department of Marketing
University of Rajshahi
Rajshahi, Bangladesh

Dr. Md. Kamruzzaman
Co-Supervisor
&
Associate Professor
Institute of Bangladesh Studies
University of Rajshahi
Rajshahi, Bangladesh

Declaration

I do hereby declare that the dissertation entitled **Employee Motivation and Human Resource Development in the Banking Sector of Bangladesh: Theories and Practices** submitted to the Institute of Bangladesh Studies, University of Rajshahi, as a part of the requirements for the degree of Doctor of Philosophy in Management is my original work. Neither the whole nor any part of it was submitted to any other university or institute for any other degree or diploma. My indebtedness to other works has duly been acknowledged at the relevant places.

Mohammad Azizur Rahman
PhD Researcher
Institute of Bangladesh Studies
University of Rajshahi
Rajshahi, Bangladesh

Acknowledgments

First of all I am grateful to the great Creator for keeping me healthy for which I have worked hard enough to do the research. There is an endless list of institutions and people to whom I am extremely indebted, without whom this dissertation could not be commenced and completed. I would like to thank the authority concerned of Institute of Bangladesh Studies, University of Rajshahi for supporting of doing my PhD programme. In the same way, I like to give thank to the concerned authority of Begum Rokeya University, Rangpur for giving me the study leave to do this PhD programme. And special thanks are given from me to the University Grants Commission of Bangladesh (UGC) to have the fellowship.

My gratitude is also the present director Professor Dr. Jakir Hossain, Institute of Bangladesh Studies, University of Rajshahi. I would like to especially express thanks to Late Prof. Dr. M. Zainul Abedin, Prof. Dr. Swarochish Sarker, Prof. Dr. Mohammad Najimul Hoque, and Dr. M. Mostafa Kamal. I am thankful to all persons concerned in the IBS, who have provided a very supportive and congenial environment.

I feel appreciative to the GM, DGM, AGM, managers, and officers of the different branches of SBL, JBL, ABL, RAKUB, PBL, UBL, NBL, DBBL, PRIMEBL, and BRAC banks operating in the three districts, namely Rangpur, Dinajpur and Nilphamari. In the same way thanks are to give Dr. M. Tazul Islam (BIBM), IBA and BIBM Library concerned. Md. M. Hossain (DGM, Statistics, Bangladesh Bank, Dhaka), Probash Chy (Joint Director, Bangladesh Bank, Dhaka), Mr. Raihan Reza (Joint Director, Bangladesh Bank, Rangpur) and Mr. Md. Habibur Rahman (Deputy Director, Bangladesh Bank, Rangpur Office) for providing fundamental information.

I am indebted to my respected supervisor Professor Dr. Md. Omar Faruk Sarker, and co-supervisor Dr. Md. Kamruzzaman of this thesis, who have frequently inspired me with critical thinking in the new ideas of human resource management practices in

the financial organizations of Bangladesh from the very beginning of this study and who have provided outstanding direction for my thesis especially in using statistical techniques to analyze the data. I also am exceptionally fortunate enough to have the massive benefit from their advanced thinking of new ideas on employees' development and motivation of Bangladeshis Banking Sector.

In the same manner special appreciation goes to Mohammad Rafiul Azam Khan (Associate Professor of Management Studies, BRUR), Md Zahid Hossain (Associate Professor of Marketing, BRUR), Md. Sadrul Islam Sarker (Assistant Professor & Head, Management Studies, BRUR), Md. Reaz Uddin (Associate Professor, SOB, KU), Mokarremul Hoque Helal Mridha (Assistant Professor of Management, BCS Education), Md. Abdul Hamid (Professor, SUST, Sylhet), Saiful Islam (Assistant Professor of Accounting, HSTU), Abu Taleb (Deputy Director, BARD), and fellows of IBS in different academic sessions for their collaboration in my research. I am grateful to Mr. Md. Shakil Ahmed (Research Officer, ICDDR, Dhaka) for his assistance in data analysis. I would like to thank Balayat Hossain (MBA, Management Studies, BRUR) for helping me read the proof of my dissertation. I would also be grateful to my other colleagues and friends who have supported my research in various ways.

It would be a great injustice to forget my parents because they enrolled me in school. My father often persuaded me to pursue a PhD. I cannot avoid the continuous support of my elder sister Lili, Kohinoor, younger Obaidur Rahman, and Bonni, and respected father & mother-in-law Mr. Md. Arfan Ali (Freedom Fighter) with Rabaka Sultana. My elder brother Mr. Jamal Uddin, Rafiqul Islam and Mustanshirur Rahman Mojnu (my uncle) who have helped me financially and emotionally in all aspects of my life. I am grateful to all the people of Purbapar Dighuli Village, my birthplace, for their direct and indirect contributions to my upbringing since childhood. In the end, my highest gratitude goes to my beloved wife, Abeda Sultana, and my sons Mugdho and Munif, to whom I dedicate this thesis. My spouse provided me with the inevitable support. Mugdho and Munif, were a constant reminder of why I was doing this study and deprived affection from me. They really inspired me to complete my PhD on time.

Rajshahi
January 2021

Mohammad Azizur Rahman

Abstract

Banking organizations are striving to enhance and build themselves into a competitive giant in the country's financial sector. Due to increasing competition, banks have to perform well in the core business which reflects sustainability in corporate business. Banks are performing four key functions of HRM to get (find), prepare, activate and keep the employees (GPAK). Human resources are the key contributor of excellence management of the banks. How to attract the brilliant manpower—is regarded the significant issue of the banks. This is why; banking organization provides the facilities, and to create the employees more skilled and efficient performing well in their assigned duties and responsibilities. They (employees) will be satisfied more depending when they perform well than the earlier they can. Satisfied employees strive to achieve the goal of the bank. This satisfaction influences by the different factors such as better packages of salary and incentives, job security, leave facilities, training and development, HRD and work environment in the workplace.

The main objective of this study is to identify stimulating factors from the motivation theories and to relate them to the Human Resource Development (HRD) Matrix along with evaluating its practices to assess employee motivation in the banking sector of Bangladesh. In this study, the final investigation was to measure the organizational effectiveness influencing employee motivation of banks. This study has been conducted on 400 employees serving the state-owned or public and private banks. The stratified random sampling technique has been used to collect data through self-administered survey questionnaire. The approach of this study is followed by quantitative method and complemented by few qualitative observations. The structured questionnaire (close-ended) survey has employed to the required number of employees (n = 400) in selected branches of the ten banks in Bangladesh. Descriptive statistics such as Frequency Distribution, Mean, Standard Deviation, P-P, Q-Q, plots and Inferential Statistics i.e., Bivariate Correlation, Chi-square Test of Fisher's Exact p-value, Levene's Variance Equality Test for Comparison, Binary Linear Regression, Binary Logistic Regression, Wald Test, ANOVA, , PCA, Exploratory Factor Analysis (EFA),

Total Variance Explained, Structural Equation Modeling (SEM) for considering the latent factors. SPSS version 21.0 and STATA version 13.0 have been used to analyze the collected data for testing the hypotheses.

There are fifteen hypotheses that have been developed based on previous literature and the objective of the study. All the hypotheses have been tested to examine the relationship between independent variables and employee motivation (dependent variable). The selective independent variables have been taken out from the motivation theories as well as HRD Matrix and practices aiming at influencing the dependent variable (employee motivation). Out of fifteen hypotheses, the nine are proved and accepted alternative hypotheses which are also statistically significant that means JCM, financial and other monetary, leave benefits, training and retention, HRD environment, organizational effectiveness (employee and organizational outcomes), performance appraisal (PA) and management practices were the responsible for employee motivation.

Significant impact of the independent variables has been ranked according to the significant over input to take decisions whenever necessary to uplift motivation to the required employees in the banks. The independent variables like fringe benefits, glass ceiling, quality of work life (QWL), HRD mechanisms, HRD process, HRD climate or OCTAPACE culture are not significant in the study that may be further reviewed under dynamic environment. Moreover, the significant independent variables may differ a bit with respect to significant ranked in the different or individual context. In the individual construction (latent factor) of each variable observed and found that there is a direct effect on employee motivation. That means, satisfaction, JCM, hygiene and motivating factors, were significant with motivation. Employee motivation signified by the demographic outlines found in the study. With the demographic issues the glass ceiling phenomenon was also examined (cause and effect basis) in the banking sector whereas, equal importance as well as pay distribution tested by logistic regression. In this case, types of bank, designation, location of job were the most effective factors. Logistic support, women advancement, delegation and authority and assigning women in a vital post for the job were the highly significant relationships with the women motivation in the banking sector. From the measurement of the structural equation modeling, each latent factor confirmed the most effective factors influencing the employee motivation. From the SEM the study found the different effective factors that influenced employee motivation such as experience, age, nature of banks, fair recruitment and selection, designation, promotion and growth, transfer, leave, profit sharing, increment, job

security, rotation of the job, retention, space and adequate ventilation, succession plan for future important post, risk job with fair rewards, team, collaboration, committed performance, lower turnover cost etc. Fair recruitment and selection is the most significant and notable effective factor of all the factors included in the latent variables.

Employee motivation of the banking sector in Bangladesh is related to the work experience, current and initial salary packages which mostly vary according to age, presence and initial positions. It has been found from the empirical analysis based on demographic outlined that the most effective factors age, present designation, first joining designation have been explored and strongly associated with employee motivation in the banking sector of Bangladesh. The study found that there is no difference in the types of bank, salary or equal treatment of both men and women. Women were divided when it comes to appointing the employees to important positions, delegating authority, moving to the top at workplace. The researcher found a strong effective factor in influencing the women while assigning in a vital post as the cause of the demotivation of female employees in banks. It has been observed that that the overall glass ceiling phenomenon of public banks was higher than that of private banks.

The existing employees are highly satisfied with the recruitment and selection practiced in the banking organization. Researcher observed that employees are highly satisfied with present pay, staffing, financial benefits and career development and moderately satisfied with the promotion and transfer and leave policy. Finally, researcher found a strong effective factor of the latent variable influencing the promotion and transfer policy as the correlation of satisfaction and motivation of existing employees working in the bank. The financial issues are being provided by the organization. These may ensure the satisfaction and motivated to the presence employee of the bank and get better with globalized world and also competitive market in the banking industry. The financial benefits specified are- allowances, bonuses, increment facilities, profit sharing, GPF, CPF, accidental benefits, transportation cost, medical facilities, launch allowances.

HRD environment, training and retention, and quality of work life (QWL) have shown the significant correlations in motivation employees. Moreover, it has been perceived that there is a significant correlation between QWL and HRD environment influencing employee behavior in the workplace of the banking industry. The researcher found there is a slightly difference practices in the public and private bank regarding work/QWL and HRD environment. The latent variable specified as employee

training and retention are strongly related to the all factors used to measure SEM. The HRD climate or OCTAPACE, performance appraisal (PA) and management practices do have the strong correlation. Employees are dissatisfied in case of autonomy involved in OCTAPACE. There is a significant impact of PA on employee motivation. MBO, fair rewarding, timely promotion, performance evaluation and upgradation have the significant effect in the influence of employee behaviour. Employee and organizational outcomes (organizational effectiveness) are highly recognized and have a significant impact on employee motivation. Individual results are highly correlated with the HRD matrix. Overall, these two latent factors have ensured the organizational performance of the banking sector supplemented by role-playing and analysis, rewarding culture for risky task, committed performance that are effective in motivating employees. Furthermore, the banks need to collaborate with Bangladesh Bank to improve the identified factors significant to create and increase employee motivation. Theoretically, the study extends motivational research by reframing the concept for application. The study made an attempt to identify the benchmarks to work with employee motivation for the management and policy makers. Therefore, with few adjustments, findings of the study might be replicated to other organizations and industries considering the proposed strategic management approach to practice satisfaction-employee motivation with similar nature.

Articles Published from this Dissertation (Enclosed in Annexure VII)

- 1) Rahman, Mohammad Azizur. “Exploration of Effective Factors of the Employee Satisfaction and Motivation in the Banking Sector: A Study on Northern Region Bangladesh.” *European Modern Studies Journal*, Ukrain, Vol. 4 (5), 2020: 82-94.

Acknowledgement: The author is indebted to honorable Professor Dr. Md. Omar Faruk Sarker (PhD Supervisor), Marketing Department, & Dr. Md. Kamruzzaman (PhD Co-Supervisor), Associate Professor, Institute of Bangladesh Studies, University of Rajshahi, Bangladesh.

- 2) Rahman, Mohammad Azizur. “Exploring Effective Factors in the Demographic and Motivation Issues of the Banking Sector of Bangladesh.” *Global Journal of Management and Business Research*, Vol. 20 (13), 2020: 1-12.

Acknowledgement: The author of this article is grateful to the honorable Professor Dr. Md. Omar Faruk Sarker (PhD Supervisor), Marketing Department, & Dr. Md. Kamruzzaman (PhD Co-Supervisor), Associate Professor, Institute of Bangladesh Studies, University of Rajshahi, Bangladesh.

- 3) Rahman, Mohammad Azizur, and Mohammad Rafiul Azam Khan. “Investigating the Effect of Women’s Position on Advancement in the Banking Sector of Bangladesh.” *International Journal of Social Sciences and Management* 7, no. 4 (2020): 191-197. DOI: 10.3126/ijssm.v7i4.32483.

List of Abbreviations and Acronyms

ABL	Agrani Bank Limited
ADB	Accidental Death Benefits
ANOVA	Analysis of Variance
BRAC	BRAC Bank Limited
CEA	Child Education Allowance
CFA	Confirmatory Factor Analysis
Coef.	Coefficient
DBBL	Dutch-Bangla Bank Limited
DoA	Delegation of Authority
DV	Dependent Variable
EFA	Exploratory Factor Analysis
EM	Extraction Method
ERG	Existence, Relatedness and Growth
FB	Fringe Benefits
FBAR	Family Benefits After Retirement
FEV	Fisher's Exact Value
FGD	Focus Group Discussion
GPAK	Getting, Preparing, Activating and Keeping People
HRD	Human Resource Development
HRM	Human Resource Management
IV	Independent Variable
IWPR	Institute for Women's Policy Research
JBL	Janata Bank Limited
JCM	Job Characteristics Model
JDI	Job Diagnostic Inventory
JS	Job Security
JSS	Job Satisfaction Survey
KII	Key Informant Interview

KMO	Kaiser-Meyer-Olkin
KSA	Knowledge, Skill and Abilities
LB	Lower Boundary
LBs	Leave Benefits
MARS	Motivation, Abilities, Role Perception, Situational Factors
MBD	Management by Drive
MBE	Management by Exception
MBF	Management by Ferment
MBO	Management by Objectives
MD	Mean Difference
MGT	Management
MPS	Motivating Potential Score
MV	Mean Value
NBL	National Bank Limited
OCB	Organizational Citizenship Behavior
OCTAPACE	Openness, Confrontation, Trust, Autonomy, Proactiveness, Authenticity, Co-operation or Collaboration and Experimentation
OMBs	Other Monetary Benefits
PBL	Pubali Bank Limited
PCA	Principal Component Analysis
PPS	Probability Proportion to Size
PrBL	Prime Bank Limited
PTP	Proper Training Policy
QWL	Quality of Working Life
R & S	Recruitment and Selection
RAKUB	Rajshahi Krishi Unnayn Bank
<i>r</i> -value	Pearson Correlation Value
S.E	Standard Error
SBL	Sonali Bank Limited
SD	Standard Deviation
Std. Err.	Standard Error
T&D	Training and Development
UB	Upper Boundary
UBL	Uttara Bank Limited

Content

Certificate	ii
Declaration	iii
Acknowledgments	iv
Abstract.....	vi
Articles Published from this Dissertation.....	x
List of Abbreviations and Acronyms	xi
Content	xiii
List of Tables.....	xxi
List of Figures.....	xxix
List of Appendices.....	xxxii
Chapter One : Introduction.....	1-28
1.1 Background.....	1
1.2 Definitions of the Key Terms	3
1.2.1 Motivation and Motivating	3
1.2.2 Motivation and Satisfaction	4
1.2.3 Motivation Process.....	5
1.2.4 Money and Motivation.....	5
1.2.5 Job Design.....	6
1.2.6 Feedback	6
1.2.7 Job Characteristics (JC).....	6
1.2.8 Job Enrichment.....	6
1.2.9 Job Characteristics Model (JCM).....	7
1.2.10 Critical Psychological States (CPS).....	7
1.2.11 Motivating Potential Scores (MPS)	8
1.2.12 Performance Appraisal (PA).....	8
1.2.13 Management by Objectives (MBO).....	8
1.2.14 Ergonomics	8
1.2.15 Quality of Working Life (QWL).....	9

1.2.16	Training and Development (T&D).....	9
1.2.17	Productivity	9
1.2.18	Gender Equity and Glass Ceiling Phenomenon	9
1.3	Theoretical Purview on Motivation Theories	10
1.3.1	Motivation Theories	10
1.4	Integrated Approach of Motivation Theories in Schools of Management	14
1.5	Human Resource Development (HRD) Matrix	14
1.5.1	Phases of HRD Matrix	15
1.5.2	Components of HRD Matrix	16
1.5.3	Organizational Effectiveness	16
1.6	Strategic Issues and Adaptation of HRD in HRM	17
1.7	Statement of the Problem.....	18
1.8	Justification of the Study	23
1.9	Significance of the Present Study	25
1.10	Scope of the Study	26
1.11	Limitations of the Study.....	27
Chapter Two : Research Context and Review of the Literature		29-60
2.1	Literature Review and Research Context	29
2.2	Research Gap	56
2.3	Research Questions	58
2.4	Overall Functional Equation of Employee Motivation in the Banks.....	59
2.5	Objectives of the Study.....	60
Chapter Three : Research Methodology		61-72
3.1	Nature of the Study	61
3.2	Selection of Study Area	61
3.3	Sample Size Determination and Distribution of Branches and Respondents.....	62
3.4	Sources of Primary and Secondary Data	64
3.5	Primary Data Collection	64
3.6	Data Analyzing Techniques	64
3.7	Statistical Analysis of the Research Methodology	65
3.8	Conceptual Framework of the Study	70
3.9	Flow Chart of Independent and Dependent Variables for Fitting Multiple Regression Model	71
3.10	Hypotheses Construction	72

Chapter Four : Demographic and Glass Ceiling Composition with Motivation Issues	73-99
4.1 Demographic Outlines	73
4.1.1 Research Questions on Demographic Outlines.....	73
4.1.2 Chapter Objective.....	73
4.1.3 Association of Demographic Outlines and Employee Motivation	76
4.1.4 Results and Discussion.....	76
4.1.5 Findings on Demographic Factors and Employee Motivation	85
4.2 Glass Ceiling Phenomenon in the Banking Sector	85
4.2.1 Background of the Glass Ceiling Phenomenon	86
4.2.2 Present Context of Glass Ceiling Phenomenon and Its Composition	87
4.2.3 Research Questions and Data Analysis of the Glass Ceiling Phenomenon.....	91
4.2.4 Developing Hypotheses on Glass Ceiling Composition	91
4.2.5 Developing Logistic Regression Model for the Perception of the Respondents	93
4.2.6 Equal Importance (EI).....	93
4.2.7 Pay Discrimination.....	94
4.2.8 Glass Ceiling Perspective to Male and Female Issue.....	95
4.2.9 Glass Ceiling Perspective of Gender and Types of Bank	96
4.2.10 Impact of Glass Ceiling on the Motivation in the Banks	98
4.3 Discussion on Findings	98
Chapter Five : Employee Satisfaction and Motivation	100-133
5.1 Relationship between Motivation and Satisfaction.....	100
5.2 Pay and Motivation	101
5.3 Employee Satisfaction	102
5.3.1 Descriptive Statistical Analysis of Different Allowances in the Banks.....	102
5.3.2 Examining the Satisfaction Level	104
5.3.3 Overall Satisfaction Score on Employee Perception	105
5.3.4 Bivariate Analysis on Satisfaction Level of Banks' Employee	106
5.3.5 Comparative Analysis on Satisfaction Level between Public and Private Banks	106
5.3.6 Measurement of SEM for Individual Factors of Employee Satisfaction.....	109
5.3.7 Effect of the Designation on Employee Satisfaction in the Banks	111
5.4 Job Characteristics (JCM) Model and Employee Motivation.....	113

5.4.1	Statistical Analysis on JCM	113
5.4.2	Pearson Correlation among the Elements of JCM with Demographic Outlines	114
5.4.3	Measurement of Motivating Potential Score (MPS) and Designation	115
5.4.4	MPS and Gender	116
5.4.5	Comparison MPS between Public and Private Bank	116
5.4.6	Impact of MPS on Employee Motivation in terms of Designation, Gender and Types of Bank.....	117
5.4.7	Comparative Analysis of JCM Practices between the Public and Private Bank	117
5.4.8	EFA for JCM and Demographic Factors	118
5.4.9	Exploring the Effective Factors of JCM Using Structural Equation Model	120
5.5	Factors Relating to Employee Motivation in the Banking Sector	122
5.5.1	Statistical Analysis on the Hygiene and Motivational Factors	122
5.5.2	Scoring of Motivation Level Based on Frequency Distribution	123
5.5.3	Bivariate Analysis on Motivational Factors by Crosstabs of Bank Types	124
5.5.4	Exploratory Factor Analysis on Hygiene and Motivating Factors	125
5.5.5	Measurement of Structural Equation Modeling (SEM) for Individual Factors of Motivation	126
5.6	Study Hypotheses of Employee Satisfaction	129
5.6.1	Normality Check for Employee Satisfaction	129
5.6.2	Charts for Employee Satisfaction and Its Normality Test	130
5.6.3	Dependent and Independent Variables.....	130
5.6.4	Investigation of Employee Satisfaction and HRD Model.....	131
5.6.5	Multiple Linear Regression Model for Analysing Employee Satisfaction.....	131
5.6.6	Results of Multiple Regression Analysis on Employee Satisfaction	131
5.6.7	Fitted Regression Model for Employee Satisfaction	132
5.7	Discussion on Findings	132
Chapter Six : Employee Benefits and Motivation		134-156
6.1	Pay and Money	134
6.2	Financial and Other Monetary Benefits	135
6.3	Financial and Other Monetary Benefits	135
6.3.1	Statistical Analysis on Financial and Other Monetary Benefits	135

6.3.2	Score Matrix of Financial and Other Monetary Benefits.....	137
6.3.3	Bivariate Association of Employee Benefits	137
6.3.4	Exploratory Factor Analysis for Financial and Other Monetary Benefits	138
6.3.5	Measuring Effective Factors of Financial and Other Monetary Benefits through SEM.....	140
6.4	Job Security (Fringe Benefits) and Employee Motivation	142
6.4.1	Statistical Analysis on Fringe (Job Security) Benefits in the Sampled Banks.....	143
6.4.2	Score Matrix of Fringe Benefits Reflecting Job Satisfaction and Motivation.....	144
6.4.3	Bivariate Analysis of Fringe Benefits for Employees' Job Security.....	144
6.4.4	Factor Analysis of Fringe Benefits	145
6.4.5	Measuring the Effective Factors of Fringe Benefits through SEM.....	146
6.4.6	Status of GPF, CPF and FBAR Entertained by the Public and Private Banks	148
6.4.7	Incentives and Individual Performance of the Respective Banks	149
6.5	Leave Benefits (LBs) in the Banks	150
6.5.1	Statistical Analysis of Leave Benefits in the Banks.....	150
6.5.2	Observation on the Perception of Leave Benefits among Bank Employees	151
6.5.3	The Association and Impact of Leave Benefits for Bank Employee	152
6.5.4	Factor Analysis on Leave Benefits for Bank Employee	153
6.5.5	Fringe Benefits between Public and Private Bank.....	154
6.6	Test of Normality of Motivation on Employee Benefits for Developing Regression Model	155
6.6.1	Regression Analysis on Employee Benefits and Motivation.....	155
6.6.2	Fitted Regression Model on Financial and Fringe Benefits.....	155
6.7	Discussion on Findings	156
Chapter Seven : HRD and Work Environment.....		157-186
7.1	Background of HRD	157
7.2	Training and Retention	157
7.3	Ergonomics and HRD	157
7.4	Significance of QWL	158
7.5	Effect of Training and Development, QWL and Retention on Employee Motivation.....	159

7.6	HRD Environment	160
7.6.1	Statistical Analysis of HRD Environment	160
7.6.2	Factors and Relationships of HRD Environment.....	161
7.6.3	Effect of HRD Environment on the Employee Motivation	162
7.6.4	Practices of HRD Environment in the Public and Private Bank.....	162
7.6.5	Exploratory Factor Analysis of HRD Environment.....	163
7.6.6	Measuring the Effective Factors from HRD Environment	165
7.6.7	Findings of the HRD Environment	167
7.7	Training and Retention	167
7.7.1	Satistical Investigation of Training and Retention.....	167
7.7.2	Relationships of Factors Included in Training and Retention.....	169
7.7.3	Impact of the Association on Training and Retention	169
7.7.4	Factor Analysis on Training and Retention	171
7.7.5	Comparative Analysis of the Practices of Training and Retention between Private and Public Bank.....	172
7.7.6	Exploring the Effective Factors from Training and Retention by Using SEM.....	173
7.7.7	Structural Relationships and Path Coefficients of Training and Retention	176
7.7.8	Short Findings of Training and Retention.....	176
7.8	Quality of Working Life (QWL).....	176
7.8.1	Statistical Investigation of QWL.....	177
7.8.2	Observation on QWL and Its Score with Pearson Correlation	178
7.8.3	Bivariate Association of the Factors Involved in QWL.....	179
7.8.4	Comparison of QWL Parctices in the Public and Private Banks	179
7.8.5	Exploratory Factor Analysis of QWL.....	180
7.8.6	Exploring the Effective Factors of QWL by Applying SEM.....	181
7.8.7	Short Findings of QWL.....	184
7.9	Multiple Relationships among HRD Environment, Training and Retention and QWL.....	184
7.9.1	Test of Normality of Motivation on HRD and Work Environment for Regression Analysis	184
7.10	Discussion on Findings	185

Chapter Eight : HRD Outcomes, HRD Climate and Employee Motivation...187-218

8.1	HRD Outcomes	187
8.2	HRD Instruments	188

8.3	HRD Processes.....	188
8.4	HRD Climate and Culture.....	188
8.5	HRD Strategy.....	189
8.6	Importance of OCTAPACE in HRD Matrix	189
8.7	Investigation of HRD Mechanisms in the Banks.....	189
8.7.1	Observation on Correlations of the Factors of HRD Mechanisms	190
8.7.2	Status of HRD Mechanisms in Public and Private Bank	191
8.7.3	EFA of HRD Mechanisms	191
8.7.4	Measuring Effective Factors of HRD Mechanisms from SEM	193
8.8	HRD Process.....	195
8.8.1	Observation on HRD Process and Its Correlation in the Banks.....	195
8.8.2	HRD Process and Its Practices in Public and Private Bank	196
8.9	OCTAPACE or HRD Climate Variables or Eight Culture.....	198
8.9.1	Overall Score and Correlation Matrix of OCTAPACE	199
8.9.2	HRD Climate Practices between Public and Private Bank	200
8.9.3	Perception of Officers and Principal Officers on OCTAPACE.....	201
8.9.4	Factor Analysis of HRD Climate Components.....	202
8.9.5	Effective Factors of HRD Climate.....	203
8.10	Performance Appraisal Practices in the Banks	207
8.10.1	Required for Performance Appraisal of the Bank Employee.....	207
8.10.2	Performance Appraisal (PA) and Motivation	208
8.10.3	Bivariate Analysis and Correlation of Performance Appraisal.....	210
8.10.4	Factor Analysis of Performance Appraisal (PA).....	210
8.10.5	Effective Factors of Performance Appraisal Explored by SEM	212
8.11	HRM/ Management Practices	212
8.11.1	Bivariate Correlations among the Factors of Management Practices .	214
8.11.2	Management Practices in Public and Private Bank.....	215
8.11.3	EFA of Management Practices	215
8.11.4	Effective Factors of Management Practices by Using SEM.....	217
8.12	Discussion on Findings	217

Chapter Nine : Organizational Effectiveness and Employee Motivation219-240

9.1	Why Need Organizational Effectiveness?	219
9.2	How HRD Outcomes Variables Contribute to Develop Employee and Organizational Effectiveness?	220
9.3	Employee Outcomes	220

9.4	Effect of Employee and Organizational Outcomes	220
9.4.1	Statistical Analysis of Employee Outcomes	220
9.4.2	Reflection of Employee Outcomes	221
9.4.3	Investigating Employee Outcomes of Public and Private Bank	222
9.4.4	Factor Analysis on Employee Outcomes	222
9.5	Organizational Outcomes.....	223
9.5.1	Statistical Analysis of Organizational Outcomes in the Banks.....	224
9.5.2	Association among the Factors of Organizational Outcomes	225
9.5.3	Organizational Outcomes Practices in the Public and Private Bank...	226
9.5.4	Factor Anlaysia of Organizational Outcomes in the Banks	226
9.5.5	Explorating Effective Factors from Organizational Effectiveness Measured by SEM.....	228
9.5.6	Structural Relationships and Path Coefficients of Organizational Effectiveness	231
9.6	Overall Impact of HRD on Employee Motivation.....	232
9.6.1	Study Hypotheses of Employee Motivation and Human Resource Development	232
9.6.2	Normality Check for Employee Motivation	232
9.6.3	Dependent and Independent Variables of Employee Motivation	234
9.6.4	Investigation of Employee Motivation and HRD Model.....	234
9.6.5	Multiple Relationships of Employee Motivation among the Constructive Factors.....	234
9.6.6	Multiple Regression Analysis Results of Organizational Effectiveness .	235
9.6.7	Fitted Regression Model for Employee Motivation	236
9.6.8	Overall Results of Hypotheses Matrix (Employee Motivation)	238
9.7	Discussion on the Findings	239
Chapter Ten : Discussion and Conclusion		241-255
10.1	Key Findings	241
10.2	Suggestions	243
10.3	Proposed ‘Strategic Management Approach to Practice Job satisfaction- Employee Motivation’	253
10.4	Future Research Opportunity	255
Bibliography.....		256-282
Appendices		283-326

List of Tables

Table 1.1:	HRD adaptation and strategic issues.....	18
Table 2.1:	Lens of the study framework for key concentrated areas	58
Table 3.1:	Sample size determination and sample distribution.....	63
Table 3.2:	Distribution of 400 employees among ten banks.....	64
Table 4.1:	Demographic outlines of the respondents	74
Table 4.2:	Regression-model summary ^b of work experience.....	76
Table 4.3:	ANOVA ^a of working experience	76
Table 4.4:	Coefficients ^a of work experience	77
Table 4.5:	Regression-model summary ^b of present basic pay.....	78
Table 4.6:	ANOVA ^a of present basic pay.....	78
Table 4.7:	Coefficients ^a of present basic pay	79
Table 4.8:	Regression-model summary ^b of present gross pay	80
Table 4.9:	ANOVA ^a of present gross pay	80
Table 4.10:	Coefficients ^a of present gross pay	80
Table 4.11:	Regression model summary ^b of initial basic pay	81
Table 4.12:	ANOVA ^a of initial basic pay	82
Table 4.13:	Coefficients ^a of initial basic pay	82
Table 4.14:	Regression-model summary ^b of initial gross pay.....	83
Table 4.15:	Coefficients ^a of initial gross pay	83
Table 4.16:	Effect of demographic factors on motivation.....	84
Table 4.17:	Effective factors of demographic issues and employee	85
Table 4.18:	Global gender gap, world economic forums (WEFs, 2020, BD: 2018, 2015, 2006)	87
Table 4.19:	Global gender gap, world economic forums (WEFs, 2020)	88
Table 4.20:	Overall leadership effectiveness by gender position (percentile scores) and in EU	88
Table 4.21:	Top five countries with highest and lowest % of women in managerial positions	89
Table 4.22:	Employed population by broad economic sector (2016-2017) and Statistics of Civil Officers and Staff in the ministries and directorates by category 2010 (in percentage).....	90
Table 4.23:	Female and male employed in the banking sector of Bangladesh and women's position in the hierarchy of management (BB Report 2019: Gender Equity Status)	90

Table 4.24: Score matrix of high, moderate and low perception (> 50%) on female employee	93
Table 4.25: Equal importance (EI) of male and female (Effective when $\text{Exp}(B) > 1$)	94
Table 4.26: Model summary of pay discrimination	95
Table 4.27: Pay discrimination (PD) ‘yes’ category (effective when $\text{Exp}(B) > 1$).....	95
Table 4.28: Glass ceiling phenomenon of male and female in the bank.....	96
Table 4.29: Glass ceiling phenomenon in the public and private banks	97
Table 4.30: Overall results of null hypotheses (H_0)	97
Table 5.1: Travelling allowance (TA) with the salary	102
Table 5.2: Lunch allowance (LA) with the salary.....	102
Table 5.3: Medical allowance with the salary	102
Table 5.4: Child education allowance	103
Table 5.5: Increment.....	103
Table 5.6: Type/Time of increment.....	103
Table 5.7: Number of yearly festival bonuses.....	103
Table 5.8: Number of incentives received in the last year	103
Table 5.9: Handsome salary structure	103
Table 5.10: Working hours.....	104
Table 5.11: Stress in the job	104
Table 5.12: Impact of banking diploma on promotion.....	104
Table 5.13: Satisfaction level of present salary (PS).....	104
Table 5.14: Satisfaction in recruitment and selection (R &S).....	104
Table 5.15: Satisfaction on financial benefits (FBs)	105
Table 5.16: Satisfaction on promotion and transfer policy (P &T).....	105
Table 5.17: Satisfaction on leave policy (LP)	105
Table 5.18: Motivation on career and development paths	105
Table 5.19: Score of high, moderate and low job satisfaction level (>200, or 0.50%) ..	105
Table 5.20: Bivariate analysis of satisfaction by crosstabs	106
Table 5.21: Status of satisfaction between public and private bank	107
Table 5.22: Descriptive analysis of satisfaction on existing opportunities	107
Table 5.23: EFA and total variance explained for satisfaction level of employees	108
Table 5.24: Measurement for SEM of employee satisfaction	109
Table 5.25: Structural path analysis of satisfaction and motivation	111
Table 5.26: Satisfaction level with present salary * present designation (equivalent).111	
Table 5.27: Satisfaction in recruitment and selection * present designation (equivalent)...	112
Table 5.28: Satisfaction level on financial benefits * present designation (equivalent) ...	112
Table 5.29: Satisfaction on promotion and transfer policy * present designation (Equi) ...	112
Table 5.30: Satisfaction on leave policy * present designation (equivalent)	112
Table 5.31: Motivation on career and development paths * present designation (Equi.) ...	112
Table 5.32: Skill variety for same position in the bank	113

Table 5.33: Task identity due to job performance in the bank.....	113
Table 5.34: Task significances due to do the job perfectly	113
Table 5.35: Autonomy of the job responsibility is available	114
Table 5.36: Job feedback from immediate authority.....	114
Table 5.37: Pearson’s correlation matrix (N=400).....	114
Table 5.38: Measuring MPS: $(SV+TI+TS)/3*(Autonomy * Feedback) * Designation$..	115
Table 5.39: Measuring MPS *crosstabs by gender	116
Table 5.40: Measuring MPS *crosstabs by nature of banks	116
Table 5.41: MPS results and effect on motivation	117
Table 5.42: Comparison of JCM practices between the sampled banks	117
Table 5.43: Descriptive analysis and test result for EFA in JCM and demographic factors	118
Table 5.44: EFA and total variance explained of JCM on employee motivation	118
Table 5.45: Measurement for SEM on JCM and demographic outlines	120
Table 5.46: Path coefficients of JCM and demographic factors	121
Table 5.47: Salary meeting basic needs like food, residence, clothing.....	122
Table 5.48: Job security	122
Table 5.49: Good relationship among colleagues	122
Table 5.50: Bank policy and administration	122
Table 5.51: Employee participation is considered for decision making	122
Table 5.52: Job is interesting, prestigious, status, power and egoistic/ self-esteem	123
Table 5.53: Promotion and growth at higher level available in the bank.....	123
Table 5.54: Recognition and reward	123
Table 5.55: Advancement in taking challenging performance.....	123
Table 5.56: Scores of high, moderate, and low motivation level (> median= 0.50%).	123
Table 5.57: Correlation of motivation level by crosstabs of nature of bank	124
Table 5.58: Descriptive statistics and test result for EFA of motivational factors.....	125
Table 5.59: EFA and total variance explained for motivating factors	125
Table 5.60: Measurement for SEM on maintenance and motivating factors.....	127
Table 5.61: Results of path coefficients of Dual Theory of motivation.....	129
Table 5.62: Normality test of dependent variable (employee satisfaction).....	130
Table 5.63: Coefficients ^a of employee satisfaction	131
Table 6.1: Handsome salary influences motivation	135
Table 6.2: Profit sharing can motivate the employees	135
Table 6.3: Bonus has positive impact on motivation	136
Table 6.4: Loan facilities give higher output	136
Table 6.5: Insurance facilities creating employee satisfaction.....	136
Table 6.6: Transportation facilities increasing satisfaction.....	136
Table 6.7: Salary deduction decreasing satisfaction	136
Table 6.8: Stopped increment impediment in satisfaction	136

Table 6.9: Stopped profit sharing barriers to satisfaction	137
Table 6.10: Scoring of high, moderate and low motivation and satisfaction (>median, or 50%)	137
Table 6.11: Bivariate correlation of financial benefits by crosstabs of bank type	137
Table 6.12: Descriptive and test results for EFA of financial and other monetary benefits	138
Table 6.13: EFA and total variance explained for financial and other monetary benefits	139
Table 6.14: Measurement for SEM: Financial and other monetary benefits	140
Table 6.15: Results of path coefficients of financial and other monetary benefits	142
Table 6.16: GPF (General pension fund)	143
Table 6.17: CPF (Contributory provident fund).....	143
Table 6.18: Medical benefits (MB)	143
Table 6.19: Accidental death benefits (ADB).....	143
Table 6.20: Child education allowances (CEA).....	143
Table 6.21: Family benefits after retirement (FBAR).....	144
Table 6.22: Score of high and low motivation level on FB/JS (>median=200 or 50%) ..	144
Table 6.23: Matrix for bivariate analysis on fringe benefits (FBs) and motivation.....	145
Table 6.24: Descriptive and EFA for fringe benefits (Job security)	145
Table 6.25: EFA and total variance explained for fringe benefits (Job security)	145
Table 6.26: Measurement for SEM of job security	147
Table 6.27: GPF and CPF and family benefits after retirement (FBAR).....	148
Table 6.28: Distribution and entertainment of yearly incentives and individual performance.....	149
Table 6.29: Maternity leave (MtL).....	150
Table 6.30: Paternity leave (PtL)	150
Table 6.31: Medical leave (MdL).....	150
Table 6.32: Study leave for higher education and development (StL).....	151
Table 6.33: Recreation leaves with allowances consecutive three years (RcL)	151
Table 6.34: Mandatory leave year wise (MnL).....	151
Table 6.35: Sabbatical leave (SbL)	151
Table 6.36: Occasional leave: national, international, religious, sudden leave etc. (OcL)..	151
Table 6.37: Scoring of high, moderate and low motivation level on LB (> 200 or, 50%)..	152
Table 6.38: Matrix of bivariate correlation on leave benefits (LBs) and motivation...	152
Table 6.39: Descriptive and EFA for leave benefits	153
Table 6.40: EFA and total variance explained on fringe benefits (Leave benefits).....	153
Table 6.41: Comparison of fringe benefits between public and private banks (compiled)	154
Table 6.42: Coefficients ^a of employee benefits (financial and fringe)	155
Table 7.1: Effect of T&D, QWL and retention on employee motivation	159
Table 7.2: Top managers sense to ensure employees enjoy their work (Enjoying work).	160

Table 7.3:	Top management trusting HRs are the most valuable asset (Valuable asset)..	160
Table 7.4:	Managers observed HRD as their responsibility to develop (HRD responsibilities)	160
Table 7.5:	HRP within the bank creating employee development (HRP_deve)	160
Table 7.6:	Succession plan is made developing employees (Succession_plan).....	160
Table 7.7:	Managers believe employee behavior can be changed at any stage (Behavior_change)	161
Table 7.8:	Culture is supportive to any employee by acquiring KSA (Supportive_culture)	161
Table 7.9:	HRD opportunities assisting to satisfy the employees (HRD_opportunities)	161
Table 7.10:	Female employees do not face obstacles to receive T&D (EEO).....	161
Table 7.11:	Score matrix of high frequency and Pearson correlation on HRD environment.....	161
Table 7.12:	Matrix of bivariate analysis with highest frequency on HRD environment.....	162
Table 7.13:	Status of HRD environment between public and private bank	162
Table 7.14:	Descriptive statistics and EFA for HRD environment.....	163
Table 7.15:	EFA and total variance explained on HRD environment.....	164
Table 7.16:	Measurement for SEM on HRD environment	165
Table 7.17:	Practices of well-designed training policy (PTP) in the bank.....	167
Table 7.18:	Top management hunts future talent (HFT) utilizing their potentialities .	167
Table 7.19:	Newly recruited employees are given induction training (Ind_Tr).....	168
Table 7.20:	Sr. managers supervise and prepare their immediate juniors (Supervision)..	168
Table 7.21:	Employees training feedback is positive on performance driven (T-feed)	168
Table 7.22:	Job-rotation in the bank enhances employee development (J-rotation)....	168
Table 7.23:	Senior delegating authority and responsibility to juniors (DoA)	168
Table 7.24:	Training increases commitment leading to low turnover (Low_Turnover).....	168
Table 7.25:	Employee training provided by the bank increases retention (Incre_retention).....	169
Table 7.26:	Sustainable training (Sus_training)	169
Table 7.27:	Scores of high and Pearson correlation on training and retention	169
Table 7.28:	Bivariate analysis of training and retention by crosstabs of bank nature ..	170
Table 7.29:	Descriptive statistics and EFA for training and retention	171
Table 7.30:	EFA and total variance explained for training and employee retention....	171
Table 7.31:	Status of training and retention in the public and private bank.....	172
Table 7.32:	SEM and measurement of training and retention in the Banking Sector..	173
Table 7.33:	Results of path coefficients training and retention.....	176
Table 7.34:	Workplace is congenial to health (WC)	177
Table 7.35:	Adequate space for movement, lighting and ventilation (AV)	177

Table 7.36: Official equipment is updated/ sophisticated (OS)	177
Table 7.37: Existing fire extinguisher is available in the bank branch (EFE).....	177
Table 7.38: Child care unit (CCU)	177
Table 7.39: Female employees do not face sexual harassment (FSH).....	177
Table 7.40: Internal environment affecting the employee retention (IER)	178
Table 7.41: Working environment affecting employee motivation (WEM).....	178
Table 7.42: Score matrix of frequency (highest > 50%) and correlation on QWL.....	178
Table 7.43: Bivariate analysis on QWL/WE *bank type	179
Table 7.44: Comparison of QWL between public and private banks	179
Table 7.45: Descriptive statistics and EFA for ergonomics or QWL	180
Table 7.46: EFA and total variance explained for QWL	180
Table 7.47: Measurement for SEM on QWL or work environment	182
Table 7.48: Coefficients ^a of HRD and work environment	185
Table 8.1: Considering HRD department in the bank as an unit (HRD_Dept).....	189
Table 8.2: Mechanism of performance appraisal (Mecha_PA)	189
Table 8.3: Review discussions, feedback, counseling and rewarding culture (RDFC)..	190
Table 8.4: Manager analyzing the roles of the employees (Role_analyse).....	190
Table 8.5: Training facility making future talent development (TFCFT).....	190
Table 8.6: OD Exercise and changing culture (OD & change).....	190
Table 8.7: Score matrix of frequency and Pearson correlation HRD mechanisms in HRD matrix.....	190
Table 8.8: Comparison of HRD mechanisms between public and private bank.....	191
Table 8.9: Descriptive and test results for EFA of HRD mechanisms.....	191
Table 8.10: EFA and total variance explained for HRD mechanisms or sub-systems	192
Table 8.11: Measurement for SEM of HRD mechanisms	193
Table 8.12: Role clarity and clarification of norms and standards (Role clarity)	195
Table 8.13: Awareness of competencies required for job performance (Aware_comptnce).....	195
Table 8.14: Risk taking and fair rewarding culture (Risk-rewarding)	195
Table 8.15: Investment on HRD (Invest_on HRD).....	195
Table 8.16: History and past culture of employees made impartially (Past_culture) ..	195
Table 8.17: Score matrix of frequency and pearson correlation of HRD process.....	196
Table 8.18: HRD process between public and private bank	196
Table 8.19: Descriptive and test results of HRD process.....	197
Table 8.20: EFA and total variance explained on HRD process.....	197
Table 8.21: Openness (O) personality for various curiosities	198
Table 8.22: Confrontation (C) (bringing employee face to face for role efficiency, satisfaction, and attitude towards work).....	198
Table 8.23: Trust (T) among colleagues through better communication.....	198
Table 8.24: Autonomy (A)	199

Table 8.25: Proactive orientation is given by the bank (P)	199
Table 8.26: Authenticity (A) and accountability in the security and fact	199
Table 8.27: Collaboration (C) or work together with others (cooperation)	199
Table 8.28: Experimentation (E) for new projects and things	199
Table 8.29: Score matrix of frequency and correlation OCTAPACE/HRD climate ...	200
Table 8.30: HRD climate or OCTAPACE between public and private bank	200
Table 8.31: Perception of OCTAPACE among Officers and POs.....	201
Table 8.32: EFA for HRD climate or OCTOPACE.....	202
Table 8.33: Total variance explained of HRD with OCTOPACE	202
Table 8.34: Measurement for SEM on HRD process and HRD climate.....	204
Table 8.35: Results of path coefficients of HRD mechanism, process and OCTAPACE.....	206
Table 8.36: PA report is made based on management by objective (MBO).....	208
Table 8.37: Mechanisms to reward any good work done by employees fairly	209
Table 8.38: Employees are being promoted on time.....	209
Table 8.39: Employees are being promoted based on seniority.....	209
Table 8.40: Employees are promoted based on performance	209
Table 8.41: Higher productivity is evaluated by the authority.....	209
Table 8.42: Lower output of employees giving demotion/ transfer	209
Table 8.43: Matrix of freq. and bivariate correlation on PA *crosstabs by nature of bank.	210
Table 8.44: Descriptive and test results of EFA for performance appraisal practices ...	210
Table 8.45: EFA and total variance explained for performance appraisal (PA) practices.....	211
Table 8.46: Strategic human resource planning (SHRP) practices	212
Table 8.47: Fair recruitment and promotion systems (Fair R&P).....	213
Table 8.48: Job description and job specification (Job S & D).....	213
Table 8.49: Academic qualification and job experience are valued (Eva_aca_quali) .	213
Table 8.50: Involvement with association is allowed (Association).....	213
Table 8.51: Exist equality and equity among the employees (Equity).....	213
Table 8.52: Employee retention policies (long-termed employment) (Retention)	213
Table 8.53: Matrix of frequency and bivariate correlation of management practices .	214
Table 8.54: Management practices in public and private bank	215
Table 8.55: Descriptive and EFA for management practices.....	215
Table 8.56: EFA and total variance explained of management practices	216
Table 9.1: Effect of HRD matrix and practices.....	220
Table 9.2: More competent and work innovative employees (Competent_inno)	220
Table 9.3: Rating better manpower development (HR_dev)	220
Table 9.4: High quality work commitment and performance (Commitment & performnce).....	221
Table 9.5: Problem solving skills leading to employee productivity (Prob_solving) ..	221

Table 9.6: Better utilization of human resources (Utilization_HR)	221
Table 9.7: Higher job satisfaction and work motivation (Satis_motivation)	221
Table 9.8: Score matrix of frequency and Pearson's correlation for employee outcomes (> 50%)	221
Table 9.9: Satus of employee outcomes between public and private bank	222
Table 9.10: Descriptive and test results of employee outcomes	222
Table 9.11: EFA and total variance explained for employee outcomes.....	223
Table 9.12: Generation of internal resources	224
Table 9.13: Better organizational health and safety	224
Table 9.14: Greater teamwork.....	224
Table 9.15: Higher productivity	224
Table 9.16: Growth and diversification.....	225
Table 9.17: Less turnover, no loss time and cost reduction	225
Table 9.18: Higher profits	225
Table 9.19: Better image	225
Table 9.20: Score of frequency and correlation of organizational outcomes.....	225
Table 9.21: Status of organizational outcomes between public and private bank	226
Table 9.22: EFA and test result of organizational outcomes	226
Table 9.23: EFA and total variance explained for organizational outcomes	227
Table 9.24: Measurement for SEM on organizational effectiveness	228
Table 9.25: Hypotheses and path coefficients of organizational effectiveness.....	231
Table 9.26: Correlation matrix of organizational effectiveness	231
Table 9.27: Normality test of dependent variable (Employee motivation).....	233
Table 9.28: Model Summaryb of employee motivation.....	234
Table 9.29: ANOVA ^a of employee motivation	234
Table 9.30: Coefficients ^a of employee motivation.....	235
Table 9.31: Hypotheses matrix.....	238

List of Figures

Figure 1.1: Motivation process	5
Figure 1.2: Job characteristics model (JCM).....	7
Figure 1.3: Maslow’s need-hierarchy model.....	10
Figure 1.4: Adam’s equity theory (Balance theory) of motivation	12
Figure 1.5: Vroom’s expectancy theory	13
Figure 1.6: Integarted approach of motivation (I) and (II) Developed by researcher ...	14
Figure 1.7: A schematic presentation of linkage between HRD instruments, processes, outcomes and organizational effectiveness (Adopted from the HRD matrix as stated by TV Rao)	16
Figure 3.1: Conceptual framework	70
Figure 3.2: Flow chart of key factors of motivation.....	71
Figure 4.1: Demographic composition and motivational issues.....	76
Figure 4.2: Histogram and P-P plot of work experience	78
Figure 4.3: Histogram and P-P plot of work experience	78
Figure 4.4: Histogram and P-P plot of present basic pay	79
Figure 4.5: Histogram and P-P plot of present basic pay	79
Figure 4.6: Histogram and P-P plot of present gross pay	81
Figure 4.7: Histogram and P-P plot of present gross pay	81
Figure 4.8: Histogram and P-P plot of initial basic pay	83
Figure 4.9: Histogram and P-P plot of initial basic pay	83
Figure 4.10: Histogram and P-P plot of initial gross pay	84
Figure 4.11: Histogram and P-P plot of initial gross pay	84
Figure 4.12: Overall leadership effectiveness by gender position.....	89
Figure 4.13: Histogram of glass ceiling and motivation	98
Figure 4.14: P-P plot of glass ceiling and motivation	98
Figure 5.1: Scree plot of satisfaction factors	108
Figure 5.2: SEM of employee satisfaction	109
Figure 5.3: MPS between officer and executive.....	115
Figure 5.4: MPS between public and private banks	116
Figure 5.5: Scree plot: job characteristics model (JCM).....	119
Figure 5.6: SEM of JCM & demographic outlines.....	120
Figure 5.7: Scree plot on motivating factors	126
Figure 5.8: SEM of hygiene and motivational factors.....	126

Figure 5.9: Fitted histogram for employee satisfaction	130
Figure 5.10: Q-Q plot for employee satisfaction.....	130
Figure 6.1: Scree plot of financial & non-financial benefits	139
Figure 6.2: SEM path of financial & other monetary benefits	140
Figure 6.3: Scree plot of fringe benefits (Job security)	146
Figure 6.4: SEM of job security (Fringe benefits).....	146
Figure 6.5: Scree plot of leave benefits	154
Figure 6.6: Histogram of employee motivaton.....	155
Figure 6.7: P-P plot of employee motivaton.....	155
Figure 7.1: Scree plot of HRD environment.....	164
Figure 7.2: SEM on HRD environment.....	165
Figure 7.3: Scree plot of training and retention.....	172
Figure 7.4: SEM of training and retention.....	173
Figure 7.5: Scree plot of QWL	181
Figure 7.6: SEM for working environment	182
Figure 7.7: Histogram of employee motivation.....	184
Figure 7.8: Q-Q plot of employee motivation	184
Figure 8.1: Scree plot on HRD mechanisms	192
Figure 8.2: SEM on HRD instruments	193
Figure 8.3: Scree plot on HRD process	198
Figure 8.4: OCTAPACE in public and private bank.....	201
Figure 8.5: OCAPACE among Os and POs in banks.....	202
Figure 8.6: Scree plot OCTAPACE in banks	203
Figure 8.7: SEM on HRD process and OCTAPACE	203
Figure 8.8: Scree plot of performance appraisal.....	211
Figure 8.9: Scree plot of management practices.....	216
Figure 9.1: Scree plot on employee outcomes.....	223
Figure 9.2: Scree plot of organizational outcomes	227
Figure 9.3: SEM of employee & organizational outcomes (Organizational effectiveness).....	228
Figure 9.4: Fitted histogram for employee motivation.....	233
Figure 9.5: Q-Q plot for employee motivation.....	233
Figure 10.1: Proposed ‘strategic management approach to practice job satisfaction-employee motivation’	253

List of Appendices

Annexure I: Levene's Test for Equality of Variances (Output Table 1 to Table 5) ..	283
Annexure II: Levene's Test for Equality of Variances (Output Table Section 1 to 5)....	284
Annexure III: Measurement for SEM on PA	284
Annexure IV: Measurement for SEM on Management Practices	286
Annexure V: Extracted Latent Factors from Measurement Table of SEM.....	287
Annexure VI: Questionnaire.....	288
Annexure VII: Published Articles from this Dissertation.....	294

Chapter One

Introduction

This chapter discussed the key concepts of human resource management, theoretical purview on different motivation theories, integrated approach of motivation theories, human resource development matrix, strategic issues and adaptation of HRD in HRM, problem statement, rationality, significance, scope and limitations of the study.

1.1 Background

Institutional efficiency and success depend on the formation and maintenance of skilled manpower in the organization. It is not to be expected that the predictable work and conduct will be obtained only by gathering suitable manpower. Therefore, it is necessary to take initiative to form effective means of human resources engaged in the organization. Such efforts to form appropriate quality personnel are called human resource development. The effective use of all means employed in the organization depends on the efficiency of the manpower engaged in it. Therefore, modern management is always striving to improve the quality of such manpower.

Human Resource Management (HRM) is the management of various activities designed to increase the efficiency of an organization's workforce in achieving organizational goals. HRM defines people as responsible for receiving training, performing at their highest level, and arranging for these employees to maintain their recognition within the organization. There are four basic functions of HRM— i) acquisition, ii) training and development, iii) motivation, and iv) maintenance. Employee development and motivation are the most significant functions of HRM. Motivation influences employee behavior and performance in workplace.

HRM is the process consisting of the acquisition, development, motivation and maintenance of human resources.¹ HRM is the process of acquiring, training, appraising, and compensating employees, and of attending to their labor relations, health and safety, and fairness concerns.² That means, HRM refers to managing human resources to

¹ David A. DeCenzo and Stephen P. Robbins, *Personnel/Human Resource Management*, 3rd ed. (USA: John Wily and Sons, 1999): 617.

² Gary Dessler and BijuVarkkey, *Human Resource Management*, 12th ed. (New Delhi: Pearson Prentice Hall Pvt. Ltd., 2011): 4

achieve organizational goal by utilizing employees' efficiently and effectively. The basic functions of human resource management are acquisition, training and development, motivation and maintenance. DeCenzo and Robbins divided the HR functions into four broad categories: (i) acquisition including strategic HR Planning, Recruitment and Selection, (ii) training and development including orientation, employee training, career development etc., (iii) motivational functions including performance appraisal, recognition, rewards, benefits and compensation, and (iv) maintenance functions including safety and health, communications, and employee relations etc..³ HRM is an integrated series of decisions through considering external conditions (economic, government, and unions), organizational conditions (nature of the organization and work), employee conditions (abilities , motivation and interests), choosing and applying human resource activities (planning, staffing, development, relations and compensation) evaluating efficiency and equity.⁴ Human resources are utilized with a view to achieving the organizational objectives like-sales that means increasing revenue and profit, expanding market, and ensuring sustainability of goodwill for the longer period. The more fundamental objective of human resource management is to inspire the employees to perform their tasks, assignments according to the goals of the organization which is called motivation enthusiastically.

Motivation refers to the process of giving priority about desired outcomes that inspire the employees to perform tasks willingly. In connection to this, incentive is one of the significant factors of motivation offered to inspire, to interest, to motivate in order to get organizational goal by utilizing the experience of the employees involved in the organization. Having enough knowledge and work experience is not enough to perform a job for an employee. The goal or objective of motivation is to achieve the best coordination among the employees in the workplace by giving (non-financial) satisfaction. Incentive is a must in order to retain human resources, because the contribution of the employees in bank industry should not be rejected. These incentives are not only financial, but also non-financial. Determining a suitable incentive or motivation plan is a complex task.

³ David A. DeCenzo and Stephen P. Robbins, *Ibid*

⁴ George T. Milkovich and John W. Boudreau, *Personnel/Human Resource Management*, 5th ed. (Delhi: All India Traveller Bookseller, 2000): 7

The motivation theories can help in choosing the proper motivation plan for the personnel. The motivational theories and their implications or practices are required due to sustain the development of the banking industry by giving priority to long term performance and also rejecting the short-term performance. There are many theories of motivation in various schools of management thought, such as Need-Hierarchy Theory, Two-Factor Theory/ Dual Theory, ERG Theory, Three Needs Theory, Expectancy Theory, Reinforcement Theory, X and Y Theory, Z Theory (Hybrid Theory), Equity Theory (Balance Theory), Job Characteristics Model (JCM) etc. Besides, TV Rao Human Resource Development (HRD) Matrix consists of three dimensions: (i) HRD mechanism, (ii) HRD process included HRD climate variables (OCTAPACE) and (iii) organizational effectiveness. Among those theories which are relevant to the context of Bangladesh has been considered in the present study. From the different theories of motivation as well as HRD Matrix identified/ common variables have been extracted (figures are shown in the respective chapters) to examine their practices in the banking sector of Bangladesh.

It is an important and challenging issue in present world because globalization has been creating a competitive and beneficial organization by transforming HRD since its commencement. HRM is very much important to adopt the situation at present world which completely depends on human resource in globalized countries. The concepts of HRD and HRM are being extremely enlarged day by day for creating the borderless market all over the world. HRM is made as a fundamental or basic task of an organization by knowledge and managerial strategies. This is why; developing and under developing countries are being tried to manage their human resources considering the essential resources. The success could not be achieved if there is no ideology, no ism, no political theory can win a greater output with less effort from a given complex of human material resources without having sound management.

1.2 Definitions of the Key Terms

1.2.1 Motivation and Motivating

Motivation is the act of inspiring people to take a desired course of action. Motivation refers to the process by which a person's efforts are energized, directed, and sustained

towards attaining a goal.⁵ It is a psychological phenomenon which converts the ability into performance. 'Motivation' refers to a state of mind to work willingly. There are three elements of motivation: energy, direction and persistence.⁶ The energy element is a measure of intensity or stimuli created by the quality effort of the employee. High level efforts are not important without proper direction. Direction gives the benefits to the employee. Motivation includes a persistence dimension that putting forth employees' effort to achieve organizational goals. In connection to this the term 'motivating' is a process of influencing employees' behavior.

1.2.2 Motivation and Satisfaction

Satisfaction is the end result of the need-want-satisfaction chain. 'Motivation' and 'satisfaction' are related to each other. Motivation refers to the drive and effort to satisfy a want or goal. But satisfaction refers to the level of contentment experienced when a want is fulfilled or not. Job satisfaction is a set of favorable or unfavorable feelings and emotions with which employees view their work.⁷ It is usually considered as individual perception or sensitive reaction to important information of work.⁸ On the other hand, job satisfaction is a pleasurable or positive emotional state from the appraisal of one's job experience.⁹ This type of attitude and feelings are created whenever the demand and values are being considered by the authority concerned of the organization. In other words, motivation implies a driven towards an outcome of performance, and satisfaction is the outcome already experienced. From the management point of view, then, a person might have high job satisfaction but a low level of motivation for the job, or the reverse might be true. Job satisfaction depends on different variables such as nature of the work, salary, promotion or upgradation, sound supervision, relationships among colleagues etc.

⁵ Richard M. Steers, Richard T. Mowday, and Debra L. Shapiro, "The Future of Work Motivation Theory", *Academy of Management Review*, July 2004: 379-387.

⁶ Naomi Ellemers, Dick De Gilder, and S. Alexander Haslam, "Motivating Individuals and Groups at Work: A Social Identity Perspective on Leadership and Group Performance", *Academy of Management Review*, July 2004: 459-478.

⁷ Keith Davis, *Organizational Behavior: Human Behavior at Work*, 9th ed. (New York: McGraw-Hill Inc, 1993): 195.

⁸ Victor H. Vroom, *Work and Motivation*, ed. (New York: John Wiley & Sons, 1964).

⁹ Edwin Locke A, "The Nature and Cause of Job Satisfaction", M.D. Dunnette (ed.) *Hand Book of Industrial and Organizational Psychology*, 1976, Vol. 1: 1297-1343.

1.2.3 Motivation Process

An unsatisfied need generates tension that stimulates or drives within the human behavior. These drives create a search behavior to achieve particular goals that will satisfy the need and lead to reduction of tension. The action taken by the individual/ person will lead to reward/goal which satisfies the need and reduces tension (**Figure 1.1**). Employee motivation is of crucial concern to management due to performance. Usually performance is determined by (i) ability (ii) environment and (iii) motivation. If any of the three factors is missed or deficient, effective performance will not be confirmed.

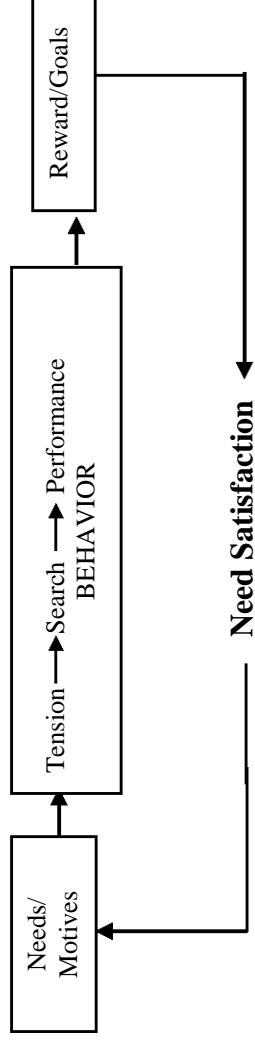

Figure 1.1: Motivation process

Source: Md. Mainul Islam and Abdul Awal Khan, *Fundamentals of Management*, 4th ed. (Dhaka: Abir Publication, 2014): 190.

1.2.4 Money and Motivation

It is a natural human tendency not to be inspired without money. That's why; many managers try to apply the key factors relating to increase salary and other fringe benefits. Classical economists considered human beings as economic-man. They believed that money is the main equipment of motivation. Researchers tried to show in their findings that personnel having money does not drive in the work. Even those who have fulfilled their psychological needs are not motivated. The Western Psychologists are not interested to diagnose money as the key factor of motivation.

Man wants to get recognition from his associates. Even he wants to sacrifice his salary for recognition.¹⁰ According to his 'Traditional Reliability' motivation does not affect. Author did not think which was not the best indicator of employee motivation.¹¹ Elton Mayo enhanced the interpersonal relationship in his Western Electric Hawthorne Experiment, whereas he (Mayo) highlighted that salary and working conditions do not

¹⁰ Castello and Zalkind, *Psychology in Administration* (Englewood Cliffs: Prentice Hall, Inc., 1963), <https://doi.org/10.1002/hrm.3930020409>.

¹¹ Whyte F. William, *Money and Motivation* (New York: Harper and Row Publisher, 1955).

increase organizational effectiveness. With a view to organizational development there could be possible to ensure employees' esteem, feelings about qualifications, autonomy and working condition.¹² From the studies it is shown that money is the fourth or fifth position in the list of the needs. The researchers suggested that security, recognition, healthy working environment are the most significant for employee motivation and satisfaction. They (authors) identified money as a hygiene factor. That's why; only money and its increment do not satisfy employee for long time. Employee thinks that money and increment is a normal condition and regarded as a basic need.¹³ Only money cannot bring satisfaction until it recognizes social status.

1.2.5 Job Design

Job design includes some important tasks for completing a job. Some factors like organizational working environment, technology, structure, employees skills, abilities and knowledge affecting job design, whereas job enrichment increases duty, autonomy and responsibility.¹⁴

1.2.6 Feedback

In case of negative results, it is possible for an employee to rectify himself immediately. Feedback informs an employee what actions are required to improve his/her efficiency.¹⁵

1.2.7 Job Characteristics (JC)

JC is a job nature being interesting and challenging.

1.2.8 Job Enrichment

Making jobs challenging and meaningful is an accepted way of motivating employees. This can be done by giving workers more freedom at workplace, giving subordinates a feeling of personality for their tasks, encouraging participation, giving subordinates feedback on their job performance; and involving workers in the analysis and change of physical aspects of the work environment such as cleanliness, layout, temperature, lighting etc.

¹² Kenneth Paul Hersey Blanchard, and Dewey Johnson *Management of Organizational Behavior: Utilizing Human Resources*, 3rd ed. (New Jersey: Prentice Hall, Inc., Englewood Cliffs, 1977): 236-244.

¹³ Frederick I. Herzberg, *Work and Nature of Man* (Cleveland: World Publishing Company, 1966).

¹⁴ Stephen.P. Robbins, and Mary Coulter, *Management* (India: Prentice Hall of India, 2006).

¹⁵ Steel Piers, *Motivation: Theory and Applied* (Boston, MA: Pearson Learning Solutions, 2012):49.

1.2.9 Job Characteristics Model (JCM)

There are five core job dimensions are skill variety, task identity, task Significance, autonomy, job feedback etc. involved in JCM showing the results of personal and work outcomes i.e. high internal work motivation, high growth satisfaction, high general satisfaction, high work effectiveness.¹⁶ The JCM provides relative guidelines to managers for designing a job individually and teams. It specifies the types of change in a job by applying the said five core job dimensions.

Theoretical aspects of JCM (Figure 1)¹⁷

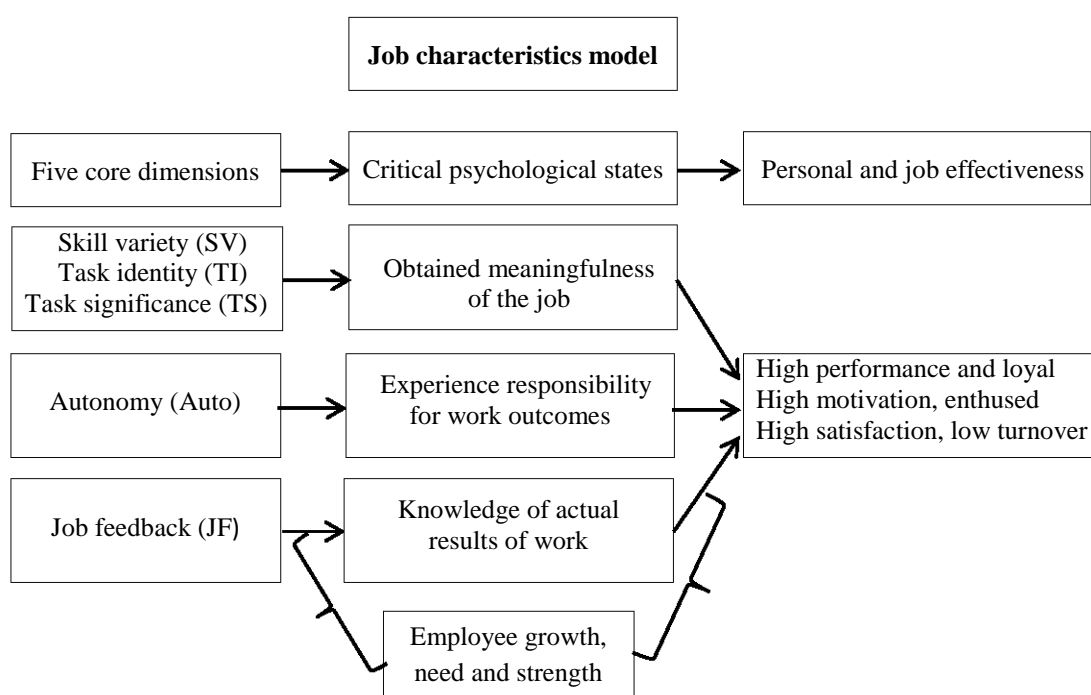

Figure 1.2: Job characteristics model (JCM)

Moderators

Knowledge and skill, high order need strength and contingent satisfaction generates the relationships with other variables of JCM.

1.2.10 Critical Psychological States (CPS)

Conceptual core of JCM explains its three psychological conditions like experienced. meaningfulness job, responsibility and result of performance.

¹⁶ J. Richard Hackman, and Greg R. Oldham, "Motivation through the Design of Work: Test of a Theory", *Organizational Behavior and Human Performance*, August 1976: 250-279.

¹⁷ Adopted JCM, from J.Richard Hackman & Greg R. Oldham, *Work Design*, 1st Edition (permitted) (NJ: Pearson Education, Inc., Upper Saddle River, 1980): 78-80.

1.2.11 Motivating Potential Scores (MPS)

$MPS = (Skill\ variety + Task\ identity + Task\ significant) / 3 * (Autonomy * Feedback)$

1.2.12 Performance Appraisal (PA)

Performance appraisal means evaluating an employee's current or past performance relative to the person's performance standards.¹⁸ It is technique of appraising someone's performance so that he/she could be motivated. PA offers competitive advantage to an organization by developing performance, taking remedial actions, ensuring legal compliance, reducing job dissatisfaction and employee turnover and ensuring consistency between organizational strategy and behavior.¹⁹ It serves many organizational goals and objectives. There are many techniques of evaluating methods of performance evaluation such as merit rating, behavioral assessment, personnel review, progress report, staff assessment, service rating, fitness report, management by objectives (MBO) etc. It measures the level of employee performance.

1.2.13 Management by Objectives (MBO)

In MBO, motivation is done by collaborative goal-setting and promise of rewards to the employees. By participating all objectives are set and at the end of the time showing result. It is an exceptional technique of motivating employees.

1.2.14 Ergonomics

Ergonomics is a discipline at the service of management from the very planning and design stage of a work system itself. For controlling of humanitarian issues included in the work system for human resource control need to be appreciated. Ergonomics can help increase operational efficiency and productivity.²⁰ ILO defined ergonomics as the application of human biological sciences in conjunction with engineering sciences to the worker and his working environment, so as to obtain maximum satisfaction for the work of which, at the same time, enhances productivity. It is related to the work environment and legal issues influencing the performance of the employees. It covers the physical working conditions. Some of the areas where the ergonomics may be applied: design of

¹⁸ Gary Dessler, *Human Resource Management*, 9th ed. (New Delhi: Pearson Education, 2003): 241.

¹⁹ K. Aswathappa, *Human Resource Management*, 6th ed. (New Delhi: Tata McGraw Hill Education Private Limited, 2011): 283.

²⁰ Dipak Kumar Bhattacharyya, *Human Resource Planning*, 1st ed. (New Delhi: Excel Books, 2002): 142.

equipment, power and hand tools, displays and warning systems, furniture, seats, rests, and steps for operators, plant layout, ventilation, sanitation, relaxation of allowances, selection, training and placement of personnel, motivation of employees.

1.2.15 Quality of Working Life (QWL)

QWL is a promising means to improve working condition and productivity. It means the degree to which members of work organization are able to satisfy important employees' needs through their experiences in the organization.²¹ It is advancement for creating innovative tasks and successful career.

1.2.16 Training and Development (T&D)

T&D change the employees' behavior affecting their performance. Training is a learning experience that seeks a relatively permanent change in an individual that will improve his or her ability to perform on the job.²² Different types of training methods are used to develop employees' skills as well as executive development programs.

1.2.17 Productivity

It is the ratio between inputs and outputs. Productivity has two aspects: organizational and personal aspects. The relationships of the two terms confirm the organizational effectiveness.

1.2.18 Gender Equity and Glass Ceiling Phenomenon

Gender equity means equal access to opportunities for both male and female to bring about change. If so, both can contribute to and benefit from, social, and economic development. The objective/goal of gender equity is to achieve social justice/fair for men and women.²³ As a result, employees of the organization will be motivated highly. The present study also evaluated the gender equity and its practices in the banking of Bangladesh.

²¹ K. Aswathappa, *Human Resource Management: Text and Cases* (New Delhi: McGraw Hill, 2013): 457.

²² David A. DeCenzo and Stephen P. Robbins, *Personnel/Human Resource Management*, 3rd ed. (USA: John Wiley & Sons, 1999): 624.

²³ UN Women Gender Equality Glossary; <https://trainingcentre.unwomen.org/mod/glossary/view.php?=&id=36>.

1.3 Theoretical Purview on Motivation Theories

1.3.1 Motivation Theories

The Researcher has tried to evaluate the theories of motivation in the schools of management and formulate a theoretical framework with a view to extracting the factors or variables from those theories so as to construct a conceptual or research framework in the study comprehensively.

1.3.1.1 Maslow's Five Need-Hierarchy Theory of Motivation

This theory is known as a first or original theory of motivation (Figure-3). In the motivation theories Need-Hierarchy Theory is the popularly best theory.²⁴

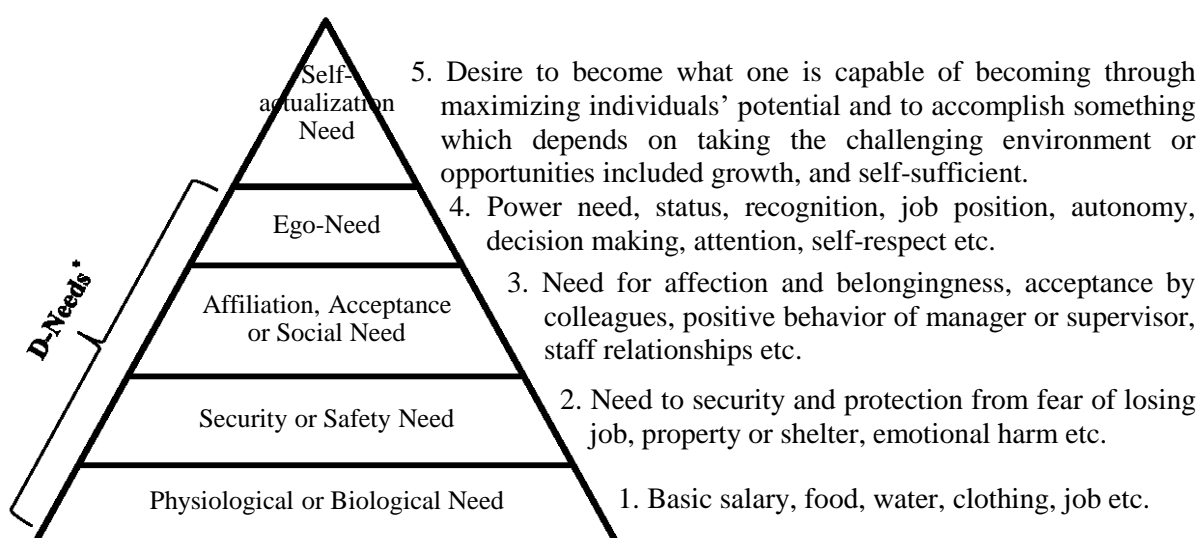

Figure 1.3: Maslow's need-hierarchy model

* D-Needs = Deficiency Needs explained by Sapna Sharma, et al, 2017.²⁵

1.3.1.2 Herzberg's Two Factors Theory or Dual Theory of Motivation

Frederick Herzberg, a well-known management theorist and psychologist in human behaviour, developed the theory through conducting a survey study of need satisfaction on employees in 1950s. This theory is established based on two things/ factors: *satisfiers* (motivational) and *dissatisfies* (maintenance or hygiene factor). The 'dissatisfies' include the factors of company policy and administration, salary, working

²⁴ Abraham Maslow, *Motivation and Personality* (New York: Harper & Row, 1954).

²⁵ Bobby Brahme Pandey and Sanjay Pandey, "An Empirical Analysis to Examine the Motivational Factors and Its Effect on Bank Employees," *Indian Journal of Social Science Research*, 2017, Vol. 14 (2): 431-437.

conditions, supervision, interpersonal relationships, status, job security, and personal life. If these factors are not available or even not provided by the organization or authority concerned the present employees will not be satisfied strongly. They could be dissatisfied highly. On the other hand, when the motivating factors are provided by the organization certainly they will be highly satisfied. The Two Factor Theory states that human needs are ordered in a series of levels of the hierarchy according to importance, which creates motivation.

1.3.1.3 Alderfer's ERG (Existence, Relatedness and Growth) Theory

This theory of motivation suggests that employees' needs are grouped into three possible overlapping categories- Existence, Relatedness and Growth.

- **Existence:** Job security, suitable working conditions, reasonable working hours, flex-time, pay and fringe benefits etc. This section is related to the Need-Hierarchy Theory of Maslow from first and second order needs i.e. physiological and safety needs respectively.
- **Relatedness:** Focuses on how people or employees relate to their social environment. It involves family, supervision, co-workers, subordinates, friends and so on which are related to Need-Hierarchy Theory of Maslow in the third one need order i.e. social need.
- **Growth:** These needs are those which compel a person to make creative or productive efforts for oneself. This section of the theory is related to Need-Hierarchy Theory of Maslow i. e. Ego-Esteem and Self-actualization needs.

Alderfer's ERG theory chains Need-Hierarchy and Two-Factor Theory of motivation.²⁶ The Existence (E) chains the basic need and job security, relatedness (R) related to social needs and growth (G) is supportive with status and highest level achievement. If a higher order needs constants or unfulfilled, an individual can degenerate to lower-order needs, which cause satisfaction.

1.3.1.4 McClelland's Three Needs Theory

D.C McClelland has discussed three types of needs. The Need for Achievement; Need for Power and Need for Affiliation. He (Theoriest) has classified managers as 'high

²⁶ P. Clayton Alderfer, "An empirical test of a new theory of human needs," *Organizational Behavior and Human Performance*. 4 (2): 142-75. doi:10.1016/0030-5073(69)90004-X.

achievers' and 'low achievers' and suggested that 'high achievers' are more successful managers than 'low achievers'. It is thus important to identify the personal characteristics of both 'high achievers' and 'low achievers' if the best is to be obtained out of people/ employees. This theory deals with showing the proper relationship between high achievement and employees' productivity. But this theory avoided the lower one's needs which are fundamental for survival.

1.3.1.5 James Stacy Adam's Equity Theory (Balance Theory) of Motivation

The Equity Theory suggests that people (employees) are motivated to seek social equity in the rewards they receive for their performances (Figure-5). This theory explains productivity, job satisfaction, absenteeism, and employees' turnover rates in the organization. It is also referred as Justice Theory or Balance Model of motivation.

$\frac{\text{Outcomes by a person}}{\text{Inputs by a person}} = \frac{\text{Outcomes by another person}}{\text{Inputs by another person}}$; Whereas, inputs are experience, knowledge, personal qualities etc. And outcomes are pay, recognition, promotion, prestige, fringe benefits etc. In that sense, employees make contributions (inputs i.e. investing time, skills, energy, knowledge etc.) for which they expect certain outcomes (rewards).

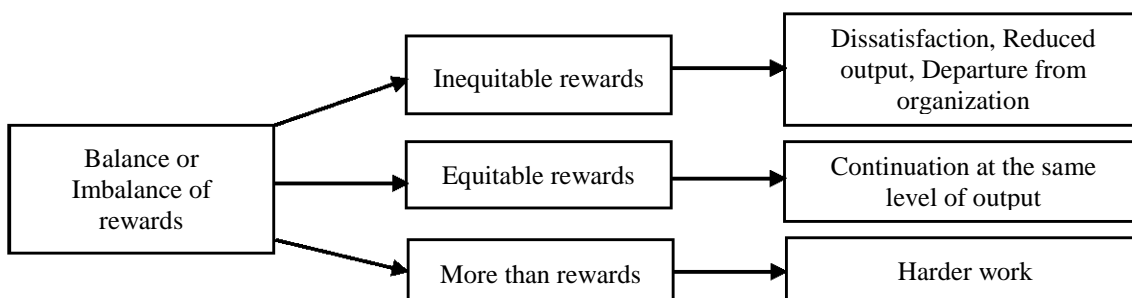

Figure 1.4: Adam's equity theory (Balance theory) of motivation²⁷

1.3.1.6 McGregor's Theory X and Theory Y

There are two distinctive views on the theory of Douglas McGregor on motivation: one thing which is included in the Theory X, where employees who dislike work. They have the negative perception. Managers compel to pressurize them for performing work. The Theoriest has suggested that the autocratic leadership style is required to have the work done by them. Remaining one part of the theory which is positive side i.e., in Theory Y

²⁷ James Stacy Adams, "Inequity in Social Exchange, *Advances in Experimental Psychology*, In L. Berkowitz Ed. (New York: Academic Press, 1965): 267-299.

that employees who like to work or engage themselves.²⁸ They want to do anything enthusiastically and are not required to put pressure. Managers can get the output by giving some ideas as participant.

1.3.1.7 Victor H. Vroom's Expectancy Theory

This theory deals with the explanation of employees' outcomes (Figure 1.5).

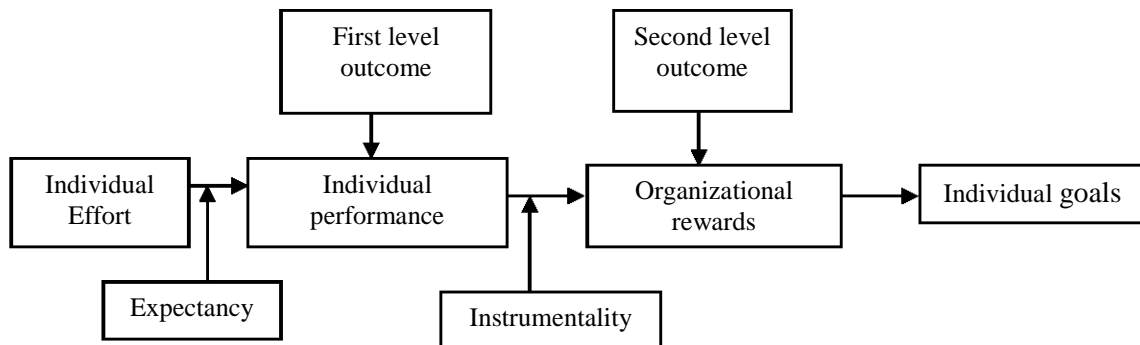

Figure 1.5: Vroom's expectancy theory

Force (Motivation) = $f(\text{valence} \times \text{expectancy})$

- **Force:** It is the strength of a person's motivation.
- **Valence:** It is the strength of a person's preference (feeling) for a particular outcome or reward.
- **Expectancy:** It is the probability that a particular action will lead to desired behavior. Or, it is the level of individual belief that a particular effort will result in certain performance.
- **Outcomes:** It is the end-results of particular behavior. Outcomes are of two categories- first level outcomes are direct and second level outcomes are viewed as consequences to which first level outcomes are expected to lead.
- **Instrumentality:** It refers to the relationship performance (first level outcome) and the reward or performance's consequences (second level outcome).

Expectancy Theory suggests that motivation depends on two things-how much of something people want and how likely they (people or employees) think they are to get it.

²⁸ Douglas McGregor, *The Human Side of Enterprise* (New York: McGraw-Hill, 1960). For more updated E. Richard Kopelman, David J. Prottas and David W. Falk, "Construct Validation of a Theory X/Y Behavior Scale," *Leadership and Organization Development Journal* 31, no. 2 (2010):120–135.

1.4 Integrated Approach of Motivation Theories in Schools of Management

This model integrated factors related to the content and process theories of motivation for which employees show their ultimate behaviour. From the different theories of motivation discussed above it can be modified as shown in the following Figure 1.6 (showing part-I and part-II; NH stands for Need-Hierarchy):

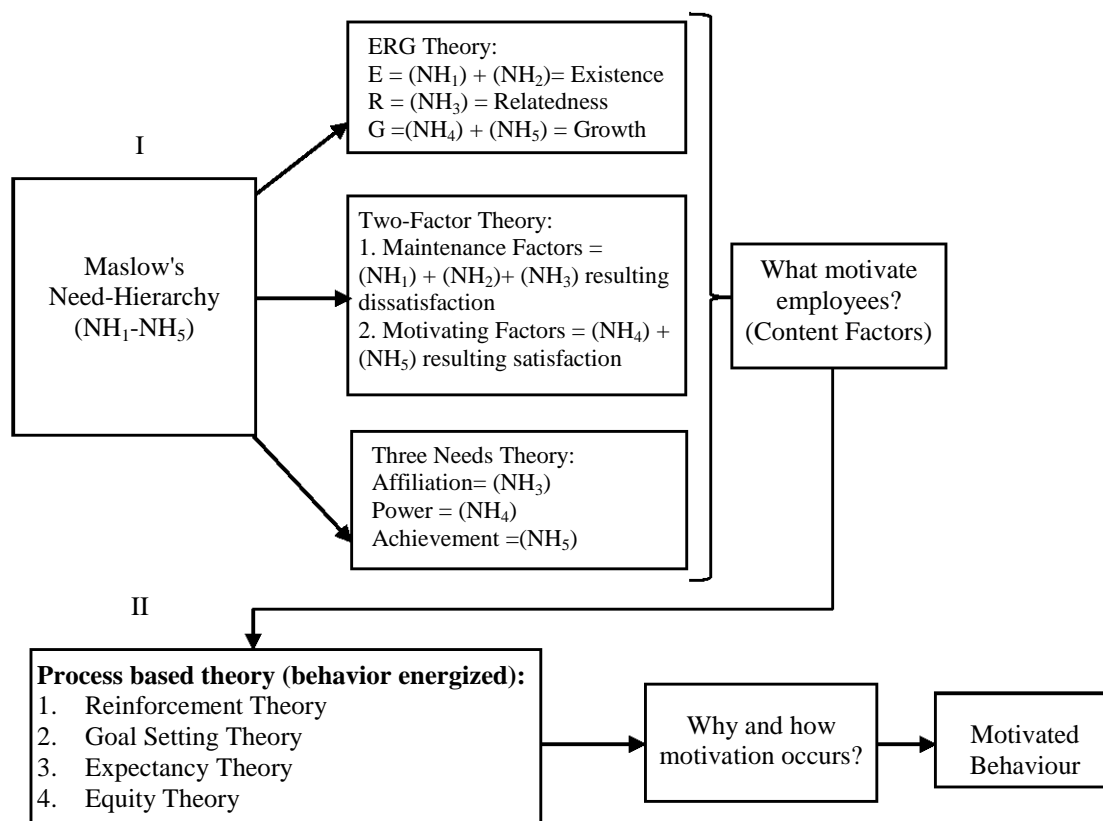

Figure 1.6: Integrated approach of motivation (I) and (II) Developed by researcher

From the figure (part-1) given above, it is perceived that shows blended picture focused on the need based four theories as such Hierarchy-Need Theory, Two-Factor Theory, ERG Theory, and McClelland's Three Need Theory. Here Need-Hierarchy Theory is the fundamental model of motivation.

1.5 Human Resource Development (HRD) Matrix

HRD matrix shows the relationship between HRD practices and organizational effectiveness.²⁹ HRD practices originate HRD processes resulting HRD outcomes that

²⁹ Dipak Kumar Bhattacharyya, *Human Resource Planning* (New Delhi: EXCEL BOOKS, 2006): 6-24.

contribute to organizational effectiveness.³⁰ HRD practices produce HRD processes succeeding in HRD outcomes that give organizational effectiveness. It enhances employees' skills, abilities and knowledge. HRD matrix includes organizational climate, and cultural variables by which employees working in the organization are motivated. Strategically management tries to practice HRD Matrix for ensuring the effectiveness. That means TV Rao developed such a matrix which is presented below:³¹ HR tools lead to obtain desired outcomes. A HR instrument may satisfy the basic philosophy of HRM which in turn, leads to competitive advantage.³²

1.5.1 Phases of HRD Matrix

1. General Climate/ Supportive Climate: it is important for effective HRD consisting of top management, and line management commitment, good personnel policies, and positive attitudes towards development human resources.
2. Mechanism/Instruments/Sub-systems: A successful implementation of HRD involves an integrated look at HRD mechanisms and efforts to use many sub-systems as possible. These include T&D, career planning and development, performance based rewards, feedback, employee counseling, job rotation etc.
3. HRD Climate/OCTAPACE Culture/ Eight Culture: This step facilitates HRD:

Openness (O): allowing employees free to express their ideas, and exchange experiences/ feelings. Confrontation (C): with a view to solving any problem employees are brought about to open their shares. Trust (T): taking employees at their face value and believing what they like to tell. Autonomy (A): getting employees work independently with job responsibilities. Proactivity (P): encouraging employees to commence new business and risks. Authenticity (A): Tendency to do what they like to tell. Collaboration (C)/Cooperation: employees are permitted to help each other or make team work. Experimentation (E): is to provide chances to practice related to workplace activities.

³⁰ T.V. Rao, *HRD Audit* (New Delhi: Response Books, 1999), and T.V. Rao, *Readings in HRD* (New Delhi: Oxford & IBM, 1991).

³¹ T.V. Rao, *Reading in HRD* (New Delhi: Oxford & IBH, 1990).

³² Michael Beer, Richard E. Walton, Bert Spector, Paul R. Lawrence, and Daniel Quinn Mills, *Human Resource Management: A General Manager's Perspective* (New York: The Free Press, 1985):17.

1.5.2 Components of HRD Matrix

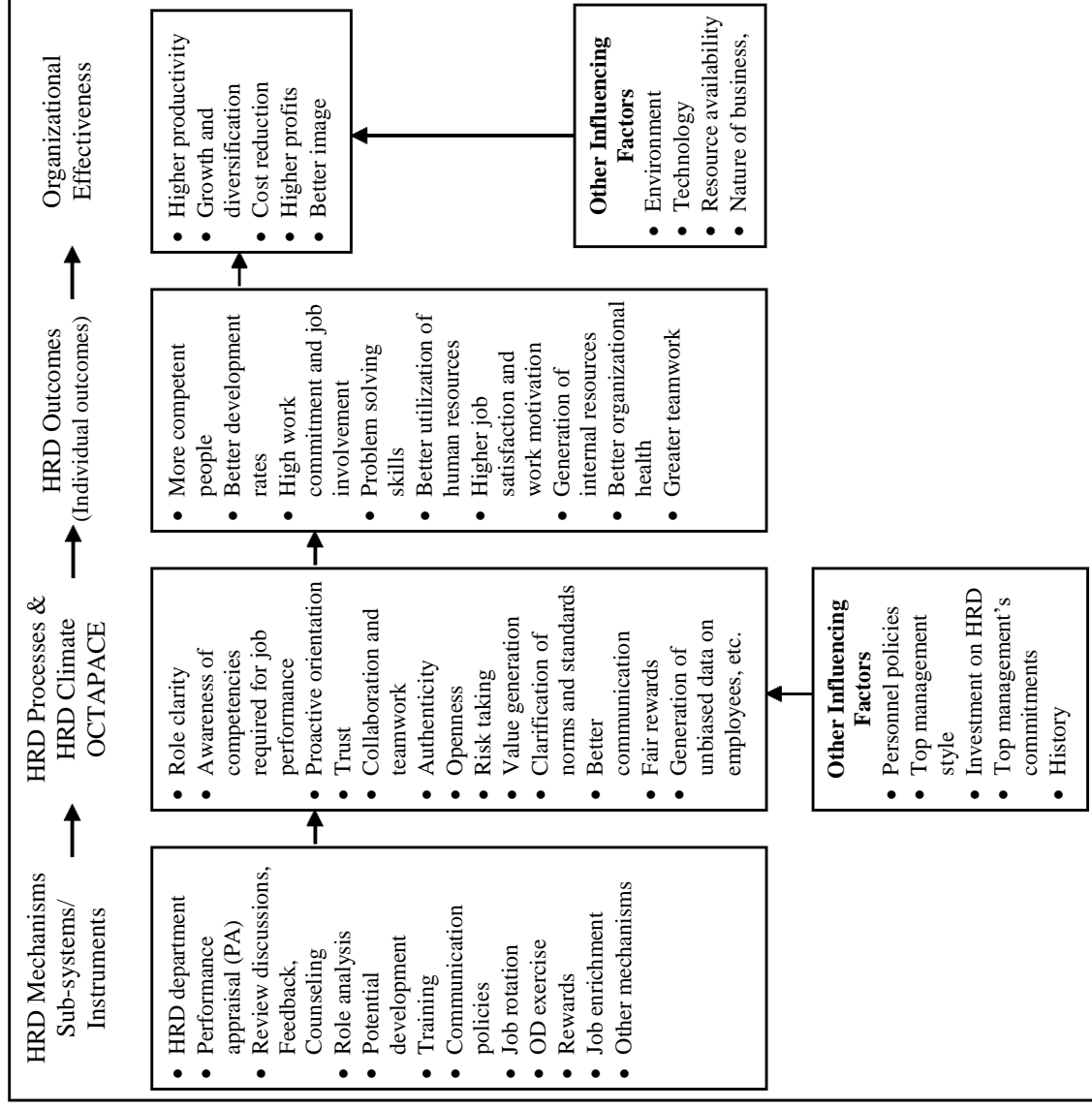

Figure 1.7: A schematic presentation of linkage between HRD instruments, processes, outcomes and organizational effectiveness (Adopted from the HRD matrix as stated by TV Rao)

1.5.3 Organizational Effectiveness

Organizational Effectiveness means how an organization obtains the outcomes of the organization intends to produce effectively and accurately. In the Organization Effectiveness over HRD, human resource managers can segment their explored job experiences in developing individuals. There is a positive relationship between HRD and organizational effectiveness. Joseph and Singh, (2000)³³ made an effort to describe

³³ Jerome Joseph and Kuldeep Singh, "Organization Effectiveness Through HRD" *Indian Journal of Industrial Relations*, Oxford and IBH Publications Co. Pvt. Ltd., New Delhi, July 2000, 36(1): ix+102-108.

in their study that states competing, execution, broadening, service organizations need to evaluation, reproduce, convey, reorient, reintroduce human resources in the organization over and done with a continuous process of separate and collective improved initiatives. TV Rao, (1990)³⁴ writes that other things are constant; an organization having skilled, satisfied, dedicated and self-motivated individuals is expected to do better than an institute that marks small on HRD outcome variables. In the identical approach, an organization that has enhanced HRD climate and processes remains to be more operative than an additional organization. It is strained that HRD outcome factors are stair faster to organization success. Organizational Efficacy, within the workplace of Human Resources, assists as a doorway to training, development, and referring resources that build organizational volume, increase separate capabilities, and encourage a values of excellence concluded strong leadership. The HRD gears if effectively recycled may create a advantageous HRD culture and HRD knowledge practices. HRD processes are midway variables and influence the HRD outcomes. They are fewer simply recognizable and are softer aspect that shows the effectiveness of HRD implements. It was found through proper practices of HRD Matrix which influenced employee better productivity, commitment, loyal, leadership style of the manager in the banking sector.³⁵

1.6 Strategic Issues and Adaptation of HRD in HRM

It can be possible to draw an attention on the strategic issue in HRM from the above purview of the key terms and its context that the banking industry can concern in the sustainability.

³⁴ T.V. Rao, *Reading in HRD* (New Delhi: Oxford & IBH, 1990).

³⁵ Anjay Kumar Mishra, "Effectiveness of Organization through Effective Human Resource Planning and Leading", *Journal of Advanced Research in HR & Organizational Management*, 2019, 06(3&4), 1-2. <https://doi.org/10.24321/2454.3268.201902>.

Table 1.1 : HRD adaptation and strategic issues

Organization	Issues	Concern	Adaptation	Result	Sustainability
External	What needs to be accomplished and what process required?	How to reach goal →	T&D and HRD Matrix: Instruments, process, climate and outcomes	Ensuring better work environment with increasing proficiency: Organizational Effectiveness	Maximizing wealth and profit and positioning competitive advantages
Internal	How do employees resolve the frequent problems related to living and work together?				

Source: Developed by researcher

1.7 Statement of the Problem

Corporate giants are facing challenges in recent world. Complexities are involved in recruiting, selecting and retaining human resources, updating government rules and regulations, political instability in this regard. Multiple studies are made on this issue in different organizations showing that employees who are passionate for their jobs and the organizations in which they work are in the minority. Retention of employees, high cost of recruiting employees is being experienced by the employers. In this competitive environment many banking institutions have taken the retrenchment strategies like forceful retirement, golden handshake, cutting salaries, stopping increment etc. A study conducted by Bangladesh Institute of Bank Management (BIBM) on Human Resource Management shows a 10% decline in the number of bank employees, from 90265 to 81245 last year in 2017.³⁶ That means about 9,020 employees lost their jobs in this sector of the year 2017. This is why; employees are scared of losing jobs. That has been done with retrenchment strategy by the banks in the country for minimizing the cost. The study showed that the present scenario is being really frustrating for the employees in banking organizations. Of the operating expenses of the banks, the entities were spending only 0.25% for human resource development. Some of the banks (one-third)

³⁶ Mahtuj Ahmed, “Jobs in Banking Sector in 2017: BIBM Study on HRM of Banks”, Workshop, *New Age*, Dhaka, 25 May 2018.

have failed to spend money (as inputs) for human resource development (HRD). Average expenditure for human resource development across the world is 2-3 percent.³⁷

A study conducted on the banks in respect to HRM where the researchers found that 67% of banks have training program and post training programs. In connection to the career counselling 67% use of banks do not counsel about career to the employees. About 90% of the banks do not have career counselling wing. The study shows that 76.19% of banks conduct motivation survey. On the other hand, 52.39% of banks offer different salary structure for the same position and status.³⁸

In the banking sector it is being found that employees are facing different stress in the workplace. Most of the employees failed to meet the target regarding deposits mobilization, credit, loan disbursement, recovery, regulatory compliance, and profits of the banks.³⁹ Most of the bank employees have performance benchmark targets set by the banks. Even at some circumstances, the bank job becomes insecure due to failure to achieve the goal. Office hours are from 10 a.m. to 6 p.m., whereas very few employees have the opportunity to leave the office from 6 p.m. This creates another stress in a banker's personal life. Many of the employees can spend shorter time for their families. Finally, employees feel burnout, job pressure, anxiety etc.⁴⁰ A study conducted in USA found that the most common source of stress comes from 61% of work pressure, 62% of money related job and many of the demographic factors like age, race, ethnicity, experience.⁴¹ In another study of UK found that 69% of financial organizations' employees felt stress in the job, whereas, UK adults agree that work is the most common cause of stress.⁴² The same study explained that the most stressful industry in the UK is

³⁷ *Ibid.*

³⁸ Mohammad Tazul Islam, Md. Masudul Haque, RexonaYesmin, Md. Rafiqul Islam, and Md. Mazharul Islam, "Human Resource Management of Banks", *Banking Review Series 2017*, Bangladesh Institute of Bank Management (BIBM): 318-19.

³⁹ Mahmud Zia Uddin, "Stress in Banking Job: Causes, Effects and Management", *The Daily Observer*, 15 July 2020.

⁴⁰ Taskina Ali and Md. K. Newaz, "Factors Contributing to Job Stress of Private Bank Employees in Bangladesh", *East West Journal of Business and Social Studies*, 2010, Vol. 1: 89-104.

⁴¹ Harris Poll, "Stress in America", *The American Psychological Association*, The American Institute of Stress (AIS), 2017.

⁴² Perkbox, "The 2018 UK Workplace Stress Survey", <https://www.perkbox.com/uk/resources/library/interactive-the-2018-uk-workplace-stress-survery>; Chieu Cao, Co-founder and Chief Marketing Officer (CMO) at Perkbox* The Labour Force Survey (LFS), November 2017, www.hse.gov.uk/statstc/tables 2018. In *The Most Stressed Workers in the UK Revealed* Chris Maccolgan, 2018 [www: https://recruitmentbuzz.co.uk/stressed-workers-uk-revealed/](http://www.recruitmentbuzz.co.uk/stressed-workers-uk-revealed/)

the finance sector, with 46% of families reporting family stress, 25% of men, 37% of women and 21% of long working hours said the main cause was work stress.

In Bangladesh about three lakh people are working in the banking sector which is actually one of the top jobs. A recent BIBM study⁴³ found that more than 50% of bankers in the country endure serious-risk levels from professional stress, about 19% suffer from dangerous levels and 35% stress is severe, 33% moderate and 12% fairly low and only 1% stress free. In the same study concluded that more than 50% of bankers suffer from occupational stress. About 60% of DGM positions bankers or holding above level position suffering extreme level of stress. Around 38% of SPO to AGM facing moderate level of stress was observed in the study. And it also found that 25% of employees within age group 35-44 years dangerous and 22% of bankers within 45-54 years suffering dangerous level of stress.⁴⁴

BIBM study found the causes of occupational stress in the banks of Bangladesh such as past office hours, imposing multiple roles or responsibilities, problematic customer handling, lack of financial rewards and appraisal, unfair promotion, poor relationship with managers or peers, lack of transportation, workplace conflict, annual confidential report (ACR), external pressure, posting location, technological upgrade, halting increment, losing retirement benefits and family benefit after retirement (FBAR), autocrat-boss, lack of job knowledge and training, overloaded task are the key factors which are responsible for stress. In some cases the HRM of the banks can create stress, if the HRD fails to pay their fairly dues which can create dissatisfaction among existing employees with the authority of the bank. Inequalities with peer banks or other industries, such as pay and other financial benefits, career growth, etc., create emotional stress among bankers. The most unexpected stress is the lack of job security. The author suggested reducing the stress by ensuring congenial work environment, career development plan, motivation for work, job-stress related training and physical exercise, meditation and healthy diet.

⁴³ Financial Express (FE) Report, "High Occupational Stress Grips Most Bank Employees", *The Financial Express Report*, December 6, 2019

⁴⁴ Mohammad Tazul Islam. (2019). *Occupational Stress and Job Performance Employees of Banks: Bangladesh Perspectives* Key Note, BIBM, Seminar, December 4, Dhaka.

Nowadays, banking has become unsafe in Bangladesh due to the unrest and huge competition in the industry. If a banker loses a job, it is very difficult for him to find another job with the same criteria due to the humiliation of losing the job.

Due to stress in the job place employees may lose their productivity adversely affecting the physical condition like chronic stress, fatigue, upset stomach, heart pressure, switching the job, absenteeism, increasing cost of medical or insurance, decreasing the image of the bank. Stress in one kind of intrinsic of banking job. This is why; it requires proper training on how to reduce stress in the overburden work load.⁴⁵ Researcher suggested mitigating the stress through performance appraisal. Stress and physical activity (PA) are thought to be related to each other; however, examining the relationship between these constructs encourages most research exercises and / or PA studies to alleviate the crisis.⁴⁶

There are some demographic and institutional factors that can be observed as significant for employee motivation in the bank such as age, work experience, basic and gross pay, incentives, HRD environment, QWL etc. Employees may be inspired by enjoying financial benefits, fringe benefits, occasional, recreation and leave benefits. Since banks are compelled to maintain the tight schedule for which many of the employees feel lethargic of their service.

Female employees are contributing a lot to the housework on the one hand and the work of the organization on the other. Their contribution to the economic development and leadership of the country is now significant and remarkable. But in the banking sector, their number is less than that of men. According to gender equity status ~18% of women employee among them 8.4% at top, 15.30% mid, 15.48% at low and 13.34% at board level positions holding in the banking sector of Bangladesh.⁴⁷ The banking is one of the stressful areas for the female employees. A study found that about 43% of female employees faced high level stress, 80% of women reported that workload was one of the major reasons of stress affecting health condition and motivation for

⁴⁵ Johnson Brooks, *Training is a Case of Stress Management. Stress and Rest Stress and Rest* (QouteMater.org).

⁴⁶ A. Mathew, Stults-Kolehmainen and Rajita Singha, "The Effects of Stress on Physical Activity and Exercise", *Sports Medicine*, 2014, January 44(1): 81-121. doi: 10.1007/s40279-013-0090-5.

⁴⁷ Bangladesh Bank (BB) Report, *Equal Gender Status*, BB Report June-January 2019, published 27 September 2019

work.⁴⁸ The same study further explained on the stress related factors like managing daily home tasks, baby care, and looking after the family members which caused stress among women in the banking sector of Bangladesh. By considering the above reason this study has investigated empirically the glass ceiling phenomenon in the banking sector as well.

HR is the most important resource and needs to be developed to achieve the institutional goals. It has to be developed in way that is beneficial both to the individual and the organization. Standing in the market and successfully coping with the competition has become one of the most important challenges for HRD. The biggest and complex challenge before HRD is to prepare its employees with changing technology. HRD managers need to upgrade employee skills and competencies to make the best use of technology improvements for business development. HRD professionals have to create models and processes for drastic transformation so that people can accept the changing workforce demographics, skills gap, and individual learning. It needs strategic leadership for competitive positioning which helps to improve performance of employees.⁴⁹

The success of 21st century organizations will depend primarily on building strategic flexibility. Practice strategic leadership to develop strategic flexibility and competitive advantage, build dynamic core competitiveness, focus and develop human capital, effectively use new products and information technology, value strategies (exploit global market and cooperation strategies) and new organization structures.⁵⁰

The future management structure of the organizations is going to face a complex threatening. Banks are to consider people as the prime resources for meeting the challenges regarding sustainable issues as well as the future operations. Now HR professionals are to face newer problems, in the up-to-date banking operations. In this case, what strategies of HRD will help banking service responds to the upcoming

⁴⁸ A.C. Das, "Causes and Effects of Stress among Working Women in Banking Sector, Bangladesh", *Mediscope*, The Journal of GMC, 216, Vol. 3(1): 1-7.

⁴⁹ R. Duane Ireland and Michael A. Hitt, "Achieving and maintaining Strategic Competitiveness in the 21st Century: The Role of Strategic Leadership", *The Academy of Management Executive* (2005), Vol. 19 (4): 63-77.

⁵⁰ Michael A. Hitt, Barbara W. Keats and Samuel M. DeMarie, "Navigating in the New Competitive Landscape: Building Strategic Flexibility and Competitive Advantage in the 21st Century", *The Academy of Management Executive* (2005), Vol. 12 (4): 22-42. <https://www.jstor.org/stable/4165492>

challenges. What are the articulate values of HRD activities and roles of HRD within the banks have already been changed? What changes in the work environment to serve “24/7” responsiveness and productivity? It is necessary to have a healthy and open climate to implement the process of HRD. Trust (T) and mutual collaboration (C) will lead to employee commitment. If the bank is able to develop the sense of belongingness then the effectiveness will be higher in the organization as it boosts the morale value of the employees.

Identifying the reasons for the motivation towards satisfaction is the concern of the authorities or the suitability of the HR professionals of the concerned banking institutions and how to alleviate the low level of satisfaction. The study findings will be useful for policy makers to introduce new opportunities and make strategic decisions in this regard. This will further help in improving the performance, efficiency and productivity of the existing staff and providing the best services to the concerned banking industry. Eventually, the banking sector will increase scale of operations. It can be concluded that there will be a platform for further study and the same level of performance will also continue.

1.8 Justification of the Study

Bank, financial institution, plays a pivotal role in finance, business and economic growth of the country. Development, growth and sustainability depend on the financial organizations significantly. Bangladesh is a developing county having huge number of banking organizations whereas a large number of employees have been working for a few decades from its inception. A remarkable contribution to the national economy is being seen in this sector. Domestic credit provided by banking sector of Bangladesh was reported at 61.44% in 2016, 64.06% in 2018 according to the World Bank Collection of Development Indicators.⁵¹ Banks have contributed significantly to the economic growth process of Bangladesh. However, their contribution would have been greater if they had addressed various challenges in the banking sector such as poor governance, lack of strong leadership and lack of ethical standards leading to various types of banking

⁵¹ World Bank (WB) Report, *Bangladesh-Domestic Credit Provided by Banking Sector (% of GDP)*, Trading Economics, 2018, 2016.

scandals such as greater money laundering and NPL.⁵² Bank employees are contributing to the goal of SDGs. In order to become a developed country by 2041, a decent number of decent jobs need to be created to provide decent employment, reasonable wages and decent standard of living.

North Bengal in Bangladesh is a full-fledged agricultural economic zone. The region was once known by the common term 'manga' (Extreme Poverty Area). Now a new horizon has begun in the economy. There have been significant changes. Now there is no 'manga'. Banking activities are gradually increasing, new entrepreneurs are being introduced, and employment is increasing, bank branches are growing rapidly. And a large number of manpower is employed in this banking industry to provide uninterrupted services to entrepreneurs and the general public. The staff employed in the bank is playing a supportive role in the economic activities of the country through their relentless efforts.

In the present study, the researcher feels that it is necessary to know the level of motivation of this huge number of people. The expansion of agro-based industries and businesses in the region will be facilitated if the staff is given utmost importance to enhance the quality of banking services. It is very important to motivate the manpower employed in the banks to enhance the banking services even for the marginalized grassroots.

If employees are demotivated, it will not be easy to ensure banking services to entrepreneurs, including the general public. As a result, the economic development of this agricultural region will be hampered. Of course, the commitment of the bank staff is very important to ensure the growth of inclusive services. Moreover, there has been considerable research on motivation in this area. Considering the above, the present research work has selected three districts of North Bengal viz. Rangpur, Dinajpur and Nilphamari through MS Excel Lottery Method. Where the researcher selected 400 respondents for a survey of structured questionnaires on staff employed in three state-owned commercial banks, one specialized and six private banks. The study will give a preview of the level of motivation of manpower in other banks of the country.

⁵² Barkat-e-Khuda, "Economic Growth in Bangladesh and the Role of Banking Sector", *Financial Express*, January 11, 2019.

1.9 Significance of the Present Study

The different studies explained that factors of motivation are more significant for banking organizations. This is why, it should be noticed that the manager of a bank having the capability to manage or to utilize the resources properly within its available resource is a successful one. Principles of motivation are not easy to establish because human behaviour is extremely complex in nature. Individual differences are substantial, and employees are continuously changing. Motivation tools and techniques are the most effective in this context. Managers should keep in their minds that only money cannot motivate employees. From the viewpoint of the said studies the researchers tried to highlight the perception of employees' job in the banking organizations of Bangladesh. In connection to this some questions are raised: What are the retention strategies of the banks? Why employees switch the job? What are the causes of employee turnover? How much rate of employee turnover? What is the impact of turnover? What is effect of outsourcing? What is the impact of recession on bank performance? In this crisis what is the strategy take by the bank? In the crisis situation what is the retrenchment strategy? How to overcome? How the talented employees could be attracted? How could the employees be developed? How do the employees maintain by the banks? How does Human Resource Development Matrix affect the operations of banking industry in Bangladesh? How ergonomics impacts the performance of the bank employee? Challenges are generated from the two sides: one is from organizational aspect (internal work environment) and another one from employees own selves (quality, attitude, family settings). These problems should be met by organizations so that the existing employees could give more attention on their jobs. That's why, continuous research could help in sustaining the banking organizations. Therefore, these challenges should be met for smooth operation of the banks. This study has attempted to find out the possible measures to deal with the challenges in light with the variables of the behavioural theories in management schools.

HRD urges to put place in the right perspective. A significant corporation has interested to impart a good deal in HRD. Having started new HR departments, most of the corporations give top-level positions to HR persons, create reasonable and sound budgets and expect the HR function facilitate a strategic advantage to their corporations. Unfortunately, only a few corporations have experienced the success. The failure of

HRD in some of the corporations is indicated by the fact that, for the first time in Bangladesh, some corporations (Banking Sector) have surrendered HRD chiefs, downsized their HR departments by replacing HR chiefs with line managers who are not so well trained in HRD. In fact, by themselves, all these may not be bad decisions. However, there are still a large number of corporations which are not able to take such tough decisions and are willing to hold the HR function along.

Recent research and surveys from the West indicate the importance of the human factor in successful corporations. They also indicate the strategic role of human resources that can play in the function of HRD. If this is true, why do some corporations fail to use their human resources for their strategic advantage, while others use it to build strong and lasting organizations and institutions? This is the point where a comprehensive evaluation of the HR functions can provide useful insights. The study offers a comprehensive evaluation of the HR function in an effort to bring into line with business goals and strategies as well as assesses the HRD practices along with functions, instruments, processes, and HRD climate/OCTOPACE culture. Over the practices banking sector will be capable of find out the gap between employee benefit as well as organizational outcomes. How much deviations of the standard regarding achieving the goals of the banks? Here, it requires to fulfil the gap for sustainable in the competitive challenges.

1.10 Scope of the Study

Many strategies are used to motivate employees. The main ones are higher wages, bonuses, promotions, job security, rewards, conventional environment, proper management, transportation facilities, medical facilities, residential facilities etc. These strategies are not applicable in all situations and not for all workers or employees. The demands of the employees should be considered by the authorities to ensure the satisfaction of the employees. Since expectations and demands are not the same for all employees. This is why; demand is different so the motivation strategy should be handled in terms of employee demands.

The present study has investigated the different factors of motivation and human resource development especially on the HRD climate variables, HRD outcomes and organizational effectiveness in the banking sector of Bangladesh. This is why; the

relating factors like satisfaction, motivational intrinsic and extrinsic, financial, non-financial, fringe, leave benefits, quality of work life, HRD environment, training and retention strategies, HRD process and mechanisms factors, OCTAPACE culture, performance evaluation, HRM practices for employee and organizational outcomes have been considered. This study attempted revealed the overall effect of HRD on the employee motivation.

1.11 Limitations of the Study

Banks' employees are engaged in the service of the day to day operations and they are busy in their activities. It could be difficult to reach them. Even those who are employed in the banking sector may not have the idea about those theories of motivation directly. In this context when the data collection from the employees researcher tried to highlight the variables through making an understandable environment. Few employees were reluctant to fulfill questionnaires. Here, there is a chance of skipping information. Besides, mass generalization of the subject matter of the theories of motivation is not possible. All the issues are not being matched with the present organizational settings of Bangladesh. Data are not being same as the organizational culture varies from bank to bank. There are various kinds of banks like traditional, Islamic Shariahbased, specialized operating over the country. It was not be possible for the researcher to take in consideration of all type of banks. On the other hand, there are huge number of motivation theories like content and process theories in management. In the study only few numbers of theories of motivation have been taken under considerations which are closely relevant to the context of Bangladesh. And in this case the theories have been discussed irrespective of the various schools of management thought.

Moreover, the research was conducted on the perceptions of bank employees (from Officer Level to GM) in a particular region that means Northern Area of Bangladesh only. Data was collected from 54% of 'Officer to Senior Officer', 39% of 'PO to SPO' and remaining 7% of 'AGM to GM' in the study (Table 4.1: Demographic Profile). The respondents of public banks were higher than the private banks' employees. Because the density of the private bank branches was lower than that of the state-owned (public) bank branches in the study area. According to sampling methodology PPS (Probability Proportion to Size) suggested that the high density

branches taken higher number of participants and in the same way, the low density of private bank branches was selected lower number of respondents. The variables are derived from the theory of motivation and the HRD matrix or model. It discusses more content-driven motivation theory; process-wised low has been shown. The motivation of officials at the administrative or policy making level was not considered. The study focuses on quantitative analysis. More research can be done on qualitative analysis for further which has been suggested in the study.

Chapter Two

Research Context and Review of the Literature

2.1 Literature Review and Research Context

This chapter contains the literature review, research gap, research questions, and objectives. In order to find out research gap, exploring variables for concentrating research questions, setting objectives as well as constructing hypotheses some published and unpublished studies have been reviewed in the present study. These are discussed below:

A study on motivational factors for finding out the effect of the public and private banks' employees that examined motivation theories such as Maslow's Need Hierarchy Theory along with other theories like Herzberg's Two Factors/ Dual Theory of Motivation, Alderfer's ERG Theory, McClelland's Three Needs Theory.¹ This study paper focused on the impact of motivational factors/ determinants and found that employees were motivated and satisfied by good remuneration, training, good culture, rewards, incentives, correct feedback, job security, performance appraisal process etc. Motivating factors in terms of different positions among employees differ across culture to culture and varies by skills and job classes as well based on needs content.

Another one study carried out on construction workers to explore the determinants of motivation and satisfaction.² The researchers examined the semi-skilled workers of different job classification such as Mason, Carpenter, Plumber, Painter and Electrician based on convenient survey on 100 respondents in Salem District, India. The research paper found that no significant difference was found in the marital status of the respondents regarding the level of satisfaction of the workers.

An assessment of motivation has found the impact of the effectiveness of bank employees among bank branches. Surveys revealed that there was a relationship between inspiration and performance.³ This research article found that employees were

¹ Sapna Sharma, Bobby Brahme Pandey and Sanjay Pandey, "An Empirical Analysis to Examine the Motivational Factors and Its Effect on Bank Employees," *Indian Journal of Social Science Research*, 2017, Vol. 14 (2): 431-437.

² M. Ragupathi and G. Prabu, "Factors Influencing Job Satisfaction and Motivation of Construction Workers in Salem District," *Asia Pacific Journal of Research*, November 2016, Vol. 1, Issue XLV: 43-51.

³ LorretaSarpong, "Effects of Motivation on the Performance of Employees of Ecobank Ghana Limited. Knust Branch and Stadium Branch," *Journal of Business Theory and Practice*, 2016, Vol. 4 (1):111-124.

gradually becoming more confident about trust, respect, high expectations, recognition and appreciation, and a better work environment. The management could make use of different strategies and policies to stimulate or motivate employees in banking environment as well. Employees were interested in enhancing salaries, housing loan, fringe benefits, and promotion and car loans as sufficient motivating elements to push employees of the bank and to give effort for their best performances. The study suggested that employees are involved in all decisions influencing their lives and concluded that 86.7% of the respondents enjoyed going to work every working day and indicated their behavior on a positive result due to present motivational packages. The study was done based on motivational theories implicated to a single bank branch in Ghana.

Vidya Nakhate stated that (2016)⁴ the F Herzberg's Two-Factor Theory of Motivation referring to the changing perception of Indian Pharma Force in Pune region. The researcher observed that motivation is morale to get more productivity and mentioned that motivation is a key factor for attracting and keeping the employees. The study applied the motivation formula as stated by Rajendra Singh, in that paper such as, $P=F(M, A, E)$, whereas M stands for *Motivation*, A for *Ability*, E for *Environment* and F for *Function* as independent variable (IV). P stands for performance considering the dependent variable (DV). The researcher explains additionally in the paper that motivation, job satisfaction and organizational orientation help in reducing the stress of the employees at moderate level.⁵ As a result outcome of the employees increases through minimizing inputs. A study was conducted by Simone De Stefania on the motivation of healthcare workers relating to the Victor's Vroom Expectancy Theory. That was done on the Italian govt. funded hospitals focusing the factors affecting the level of motivation of medical and nursing staff, such as expectancy (E), valence (V) and instrumentality (I), and the workers' motivation.⁶ Victor (1964) suggested the formula: $M=E*V*I$. The multiplier effect in the equation is significant.⁷ It means that higher levels of motivation will show the behavior when expectancy, instrumentality, and valence are all high than when they are all low. If any one of the three factors is

⁴ VidyaNakhate, "Critical Assessment of Fredrick Herzberg's Theory of Motivation with Reference to Changing Perception of Indian Pharma Field Force in Pune Region," *The International Journal of Business & Management*, January 2016, Vol. 81 (1):182-190.

⁵ Rajendra Singh, "Pleasure at the Workplace," *HRM Review*, September 2006, 54-57.

⁶ Stefania De Simone, "Expectancy Value Theory: Motivating Healthcare Workers," *American International Journal of Contemporary Research*, April 2015, Vol. 5 (2): 19-20.

⁷ Victor H. Vroom. *Work and Motivation* (San Francisco: Jossey-Bass, 1964).

zero, the overall level of motivation is zero. Therefore, if an employee believes that his/her effort will result in performance, which will result in reward, motivation will be zero. If the valence of the reward he expects to receive is zero, i.e, if he/she believes that the reward he/she will receive for his/her effort has no value for him.

Researcher analyzed that a person is motivated to the degree that he/she believes that (a) will lead to acceptable performance (expectancy), (b) performance will be rewarded (instrumentality), and (c) the value of the rewards is highly positive (valence).⁸ Expectancy is a person's estimate of the probability that job-related effort in a given level of performance ranging from 0 to 1. Instrumentality is an individual's estimation of the probability that a given level of achieved performance will lead to various outcomes ranges from 0 to 1 with expectancy. Valence is the strength of an employee's preference for a particular reward. If an employee is indifferent to a reward, valence will be zero. The total range shows from -1 to +1. This paper identified several important things in the workplace like training and education, work autonomy, professional growth, and information technology and innovation that should be done to motivate employees of the hospitals. In the article, the researcher suggested how it is possible to improve the quality of leadership so that employees can be employed in the workplace and earn more output through their best performance.

The researcher found that 76.2% of the respondents believe that they were benefited (attracted) due to work environment, 17.3% are not benefited from environment and the rest of 6.5% are benefited from passion for work. That was an empirical study showing that 52.6% of the workers are quite satisfied.

A study investigated through an empirical research on the perception of employees' regarding motivation in the public and private commercial banks in Bangladesh. The researcher found that the employees of private commercial bank are slightly more motivated than that of public commercial banks.⁹ A study explored the financial and non-financial variables as determinants with employees' satisfaction of

⁸ C. Fred Lunenburg, "Expectancy Theory of Motivation: Motivating by Altering Expectations," *International Journal of Management, Business and Administration*, 2011, Vol. 15(1): 1-6.

⁹ Md. Hasebur Rahman, "Employees' Motivation in Public and Private Commercial Banks in Bangladesh: A Study on Need-Based Approach," *Global Disclosure of Economics and Business*, (2013), Vol. 2 (2):84-91.

banking institutions in Bangladesh.¹⁰ This paper is done based on practical interview with some of the mid and high level bank officials who have opined about some organizational factors. Authors have not analysed the theories of motivation specifically. A study conducted on employee turnover intention of telecommunication and banking industries in Bangladesh explored the effect of dependent variable (turnover) and got countless factors associated with employee turnover intension.¹¹ This paper is made on the basis of some determinants. The researchers attempted to identify the significant factors and the level of job satisfaction among the bank employees in Bangladesh.¹² The study revealed some common factors such as interesting job assignments, friendly working condition, competitive remuneration packages, job security, and good relation with boss which lead to satisfaction. This was done on 31 respondents only. A study of identified and tested the factors that are related to job design, motivation and satisfaction among the employees in developing countries and found that present employees did not satisfy with their jobs.¹³ This study has been done only for developing service quality of banks in Bangladesh.

The determinants of de-motivation of the employees are those such as delay promotion, no clear career progression, unreasonable load, long working hours, and lack of recognition from the managers. The study paper recommended that monetary rewards are being motivating the employees and there should have a comprehensive motivation scheme which affects the employees' performance.¹⁴ The author explained in another study has given the attention on job enrichment, and performance variables like working environment, work load, promotion, and recognition, training and development.¹⁵ The researcher reviewed the MARS model (Motivation, Abilities, Role Perception, and

¹⁰ Mohammad Ariful Islam and Tazrina Farah, "Job Facilities and Employee Satisfaction: Exploring the Situation of Banking Institutions in Bangladesh," *Dhaka University Journal of Business Studies* (April 2014), Vol. XXXV, No. 1: 105-122.

¹¹ Mohammad Abdul Jabbar and Md. MesbahUddin, "Employee Turnover Intention in Bangladesh," *Dhaka University Journal of Business Studies*, (April 2014), Vol. XXXV, No. 1: 141-150.

¹² Md. MaminUllah, and SabnamJahan, "Identification of Critical Factors Regarding the Job Satisfaction among the Employees in Bangladesh: A Study on Bank Industry," *Dhaka University Journal of Business Studies*(December 2013), Vol. XXXIV, No.3: 121-138.

¹³ MM Hossain, "Strategy for Improving the Quality of Bank Services in Bangladesh," In Reb, Aed, *Management Development: Growth With Equity*, (1998), AMDISA, p. 275.

¹⁴ Pamela Akinyi Omollo, "Effect of Motivation on Employee Performance of Commercial Banks in Kenya: A Case Study of Kenya Commercial Bank I Migori County," *International Journal of Human Resource Studies*, 2015, Vol. 5 (2): 87-103.

¹⁵ *Ibid.*

Situational Factors) as well in this connection. Unless all of the elements of MARS model will affect negatively, motivated employees with high enthusiastic runs the work-ability, and understands the job duties- roles perception well. Employees are not able to perform their duties well if the organization lacks adequate situational factors. Questionnaires were established on the effect of monetary reward, job enrichment, training and performance, team building of the Keneyian Commercial Bank employee. In this study paper researcher explored the variables perceived by the employees of the bank industry in a state of Kenya on the basis of Maslow's Need Hierarchy Theory and Herzberg's Two-Factor Theory of Motivation.

A study was conducted on 200 executives among 20 Real Estate Companies in Dhaka City to find out the key factors of job satisfaction.¹⁶ The study revealed that employees were motivated to have secure job and promotion. Money was considered by the employees only an extrinsic factor. Here employees are to get intrinsic opportunities so as to retain in the company for a longer period of time. The researcher simply stated here that the job satisfaction determinants of real estate firms pay for other financial benefits, promotions, supervision, and peer relationships of the firms. Researchers have explored staffing of individual subjects as well as externalities but have not tested motivation theories.

Researchers conducted a study that shows the relationship among the factors like financial as rewards, personal traits, high salary plans, job design and supervision considering independent variable and employee motivation as dependent variable.¹⁷ In the study researchers found that there is a positive impact on employees' motivation. Attached to this article, it is stated that financial rewards as a result of loyalty are strong motivators to increase employment and make employees feel more secure.¹⁸ Design of job does have positive impact of employees so as to apply their knowledge in the workplace

¹⁶ Md. ShibliShahriar, "Job Satisfaction of Employees: A Study on Real Estate Companies in Dhaka City," *Daffodil International Journal of Business and Economics* (December 2015), Vol. 9 (2): 79-93.

¹⁷ Naeem Akhtar, Shazad Aziz, ZahidHussain, Saqib Ali, and Muhammad Salman, "Factors Affecting Employees Motivation in Banking Sector of Pakistan," *Journal of Asian Business Strategy*, (2014), Vol. 4 (10): 125-133.

¹⁸ Antonios Panagoitakopoulos, "The Impact of Employee Learning on Staff Motivation in Greek Small Firms: The Employees Perspective," *Development and Learning in Organizations an International Journal*, (2013), Vol. 27 (2): 13-15.

and fulfill their activities.¹⁹ The quality of supervision increases motivation, where there are good rewards for motivating employees in the pay plan.²⁰

The researchers attempted to inspect the impact of motivation on the performance of employees working in private commercial banks located in Karachi, Pakistan. The researchers have attempted to prove that without motivation it could be hard to attain employees' satisfaction and efficient performance towards organizational objectives. Financial and non-financial rewards are involved showing the relationship between banks employees and performance. In the study noticed that lack of performance evaluation with unfair rewards system could be raised de-motivation which might create hindrance to efficient performance of the employees. Empirically researchers studied on 50 employees of private commercial bank in Pakistan that there had no motivation theory applied specifically in this regard.²¹

A study investigated the effect of motivation on employee productivity in manufacturing industries in Nigeria. In this study researchers had looked into the importance of motivation in the management of people at work. The researchers said that without proper use, human resources could not be able to reach its goal. Surveys have shown that workers in the manufacturing industry are poorly motivated. Because of this, low productivity junior employees have the opportunity to be promoted and those who are senior have promotional and incentive benefits. This paper suggested that incremental pay through promotions, overtime allowances and vacation pay should be used as a tool to motivate. Researchers had made of 400 respondents and explored the variables based on Maslow's Need Theory, ERG Theory, Theory X and Theory Y, McClelland's Three Need Theory, Vroom's Expectancy Theory and tested the application of those theories of motivation in the manufacturing industries.²²

¹⁹ Idem.

²⁰ Fang Yang, "Work, Motivation and Personal Characteristics: An In-Depth Study of Six Organizations in Ningbo," *Chinese Management Studies*, (2011), Vol. 5 (3): 272-297.

²¹ Asif Uddin, and Mohammad AbuzarWajidi, "Impact of Motivation on Performance of Employees in Private Banking Sector of Pakistan," *Global Journal of Engineering Science and Research Management*, (August 2014), Vol. 1 (4): 41-48.

²² Edwin Maduka Chukwuma. and Obiefuna Okafor, "Effect of Motivation on Employee Productivity: A Study of Manufacturing Companies in Nnewi," *International Journal of Managerial Studies and Research (IJMSR)*, (August 2014), Vol. 2 (7): 137-147.

In another study, the theory of motivational expectation was evaluated theoretically by considering process theory. This paper examined the theory (expectation theory) and tries to reveal its features, qualities and qualities in the context of business management. The study concludes that the expectation theory is effective in many cases, despite its weaknesses. The researchers tried to show in the article that three relationships are involved in their analysis. These relationships are- (i) Efforts and performance known as Expectancy- E, (ii) Performance and rewards/ work outcomes known as instrumentality- I, and (iii) Rewards/ outcomes and personal goals known as valence-V. The study is established on theoretical assessment.²³

An investigative study has been conducted based on the satisfaction of college teachers in Comilla District Bangladesh. The results of the survey showed that there are significant differences across age, gender, rank and pay scale, years of experience, academic degree and job satisfaction across academic results. The paper only hints at increasing the satisfaction of college teachers.²⁴ Another study was conducted with experience on the content and process theories of inspiration. Researchers attempted to explore variables for which productivity or performance is showing positive results. Managers were interviewed and show how UK Boots 2012 increased employee motivation at the UK Pharma chain confirmed in the study.²⁵

The researchers examined the Equity Theory and attempted to show the utility in enhancing organizational effectiveness. That study was developed based on individual pay in motivating employees and improving their productivity. The researchers of the study examined the different factors compared to pay such as job satisfaction and pay equity, motivation and pay, occupation and pay, performance and pay etc. The researchers have seemed consistent pay system with fair outcome of the individual. Inconsistent pay de-motivates employees. The study suggested to the HRD that it should

²³ Pranav Parijat and Shilpi Bagga, "Victor Vroom's Expectancy Theory of Motivation- An Evaluation," *International Research Journal of Business and Management-IRJBM*, (September 2014), Vol. VII (9): 1-8.

²⁴ Shaikh Moksadur Rahman and Sayedul Al-Amin, "Job Satisfaction among College Teachers in Comilla District, Bangladesh," *Dhaka University Journal of Business Studies*, (April 2014), Vol. XXXV (1): 227-243.

²⁵ Nazir Khurram, "Employee Motivation, Job satisfaction & Productivity of Employees at Boots 2012 (WestField Stratford City)," *Master Thesis in Business Administration*, Cardiff Metropolitan University, May 2013.

be more concerned with the pay factor so as to attain the organizational goal.²⁶ The greater the inequality, the more individuals feel the crisis and the more they will try to restore equity.²⁷ Whether a social exchange is considered equitable or inequitable depends upon the individual's perception of the relationship between their inputs, namely job engagement, experience, qualification, etc. and outcomes.²⁸ Another study attempted to explore the pay perceptions and satisfaction among employed people with a random. The researchers found that the more the employees strongly agreed that their pay was fair; the more satisfied they were with their earnings. In fact, pay equity was a strong predictor of pay satisfaction.²⁹

An empirical analysis was run focusing on motivation, job stress, and job performance in Banking Industry of Greece. The researchers studied on 143 employees to analyse the ERG Model of Motivation for multi needs. The positive impact has been shown between motivation and performance despite the job stress. Researchers suggested implementing the model for developing HR strategies and policies so as to adopt with the competitive edge in business. The researchers stated and analysed the ERG theory only.³⁰ Collectively, a relationship has been shown between the motivation and job satisfaction of the 45 white collar (supervisor and above) employees of India's public sector giants. Researchers have designed a functional model such as: $M = F(JS)$ where, M is the motivation (dependent variable), JS satisfaction (independent variable) and JS for the F function. The results revealed that motivation increases with increasing job satisfaction. The study looked at the effects of age and the motivational level experience of employees. About 70% of the employees were motivated that noticed in the

²⁶ Abdelghafour Al-Zawahreh and Faisal Al-Madi, "The Utility of Equity Theory in Enhancing Organizational Effectives," *European Journal of Economics, Finance and Administrative Sciences*, 2012, Issue 46: 158-170.

²⁷ Jams Stacy Adams, "Wage Inequities, Productivity, and Work Quality," *Industrial Relations*, (1963), Vol. 3: 9-10.

²⁸ Jams Stacy Adams, "Toward an Understanding of Inequity," *Journal of Abnormal and Social Psychology*, 67 (1963): 422-436; J.S. Adams, "Inequity in Social Exchange," *Advances in Experimental Psychology*, ed. In L. Berkowitz (New York: Academic Press, 1965): 267-299; J.S. Adams & S. Freedman, "Equity Theory Revisited: Toward a General Theory of Social Interaction," *Advances in Experimental Social Psychology*, 9 (1976): 421-436; I. Berkowitz, ed., *Advances in Experimental Social Psychology* (New York: Academic Press Inc., 1965); E.B. Walster, E. Bercheid, & G.W. Walster, "New Directions in Equity Research," *Journal of Personality and Social Psychology*, 25 (1973): 151-176.

²⁹ Leonard Berkowitz, Colin Fraser, F. Peter Treasure, and Susan Cochren, "Pay, Equity, Job Gratification, and Comparisons in Pay Satisfaction," *Journal of Applied Psychology*, 72 (1987): 544-551.

³⁰ Nikolas Kakkos, and Panagiotis Trivellas, "Investigating the Link Between Motivation, Work Stress and Job Performance: Evidence from the Banking Industry" (paper presented at the 8th International Conference on Enterprise Systems, Accounting and Logistics -8th ICESAL, Thassos, Greece, 10-12 July 2011).

study. The study was developed only white collar employees avoiding the specific theory of motivation.³¹

The researcher focused on how the factors like intrinsic, extrinsic, equity, internal-external locus control, goals, mission, vision, link with Expectancy Theory. Researcher signified in the paper about goals or expectation, unlocking potential of employees, effort, equity, communication, and performance for managerial implications. Empirically researcher analyzed important conditions for improving employees' motivation. These conditions are such as communication, listening encouragement, agreement, reporting for feedback. In this article researcher had not considered other theories either content or process theories of motivation.³²

Researchers examined the different theories of motivation empirically of the Swedish bank industry showing comparison between men and women motivation. Employees are motivated by the factors such as good relations and appreciation from co-workers and managers. They are also motivated by that kind of environment for having responsibility with career growth. The important factor was signified for the women worker to feel safety and security at workplace.³³

Another one study on employees of public and private insurance companies and shown the relationship among job design, motivation, and performance. The study has been carried out on 40 executives of various levels of two insurance companies in public and private sector of Bangladesh. The study revealed that executives of the insurance sector in Bangladesh are motivated in their job in terms of task variety, job identity, clearly defined authority and responsibility, accountability, information processing, internal co-ordination, and job security. Meanwhile, they are de-motivated and dissatisfied with the most of the job design factors like as autonomy, participation in related decision,

³¹ S.K. Singh, and Vivek Tiwari, "Relationship between Motivation and Job Satisfaction of the White Collar Employees: A Case Study," *Management Insight*, (December 2011), Vol. VII (2): 31-39.

³² Isaac Mathibe, "Expectancy Theory and its Implications for Employee Motivation," *Academic Leadership: The Online Journal*, (Summer 2008), Vol. 6 (3), Article No. 8, available: <https://scholars.fhsu.edu/alj/vol6/iss3/8>.

³³ Bergstrom Andreas and Ternehall Mattias, "Work Motivation in Banks- Are There Between Sexes?," *Thesis*, June 2005, Master in Business Administration, Internationella Handelshogskolan, Sweden.

recognition and acknowledgement of job, opportunities for promotion, and training status of payment, non-financial incentives, feedback of the job and environment.³⁴

Men cannot accept female bosses and co-workers even if they feel that female peers are not adequate enough to take a level of decision making that affects their careers and that female co-workers are dominated by male co-workers.³⁵ The research has been shown that Bangladeshi corporate sectors have been dominating women in male society since before they started. Social values, culture, norms and religious beliefs do not allow women to make decisions. They are left behind socially and mentally.³⁶ A separate participant in a study reported that researcher declined a higher level position due to family obligations because it would take a lot of dedication and time to be accepted.³⁷ The study considered accounting as a political structure involved in perpetuating inequality with reference to the global gender challenges.³⁸ In that study, researcher examined the glass ceiling within the context of the accounting professions. The study found that the availability of holiday policies is strongly linked to the decline in South Korean output. Other issues involve family conflicts among female workers due to domestic chores. One survey highlighted that women were restricted from top management and having not fairly nominated to the delegation (DoA). The study found that there were many barriers for women in higher executives and managerial positions, as well as the impact of glass ceilings on women's recruitment and promotion. One research article argued that women's representation in the civil service is on the rise, but the presence of women in higher positions was much lower, indicating the existence of some barriers to women's advancement.³⁹ The authors also raised formal and informal

³⁴ Basir Ahmed Bhuiyan, K.M. Mortuza Ali, M.A.A. Nurunnabi, and Tofayel Ahmed, "A Study of Relationships among Job Design, Motivation and Performance of the Employees in the Insurance Sector of Bangladesh," *Insurance Journal*, (July 2003), Vol. 54: 35-57.

³⁵ Sonia Rezina, and Farhana Mahmud, "Gender Disparity in Bangladesh and Its Impact on Women in Workplace", *Scholar Journal of Business and Social Science*, 2016, Vol. 2(2): 27-34.

³⁶ Md. Akram. Hossain, "Working Environment for Female Employees in Bangladesh Corporate Sector Organizations: An Exploratory Study", *South Asian Journal of Policy and Governance*, 2016, Vol. 38(1):4975.

³⁷ K. Nancy Weidenfeller, "Breaking through the Glass Wall: The Experience of Being a Woman Enterprise Leader", *Human Resource Development International*, 2012, Vol. 15(3):365.

³⁸ Kathryn Haynes, "Accounting as Gendering and Gendered: A Review of 25 Years of Critical Accounting Research on Gender", *Critical Perspectives on Accounting*, Elsevier, 2018. DOI: 10.1016/j.cpa.2016.06.004.

³⁹ Sayeda Lasna Kabir, and SK Tawfique M. Haque, "Bashing the Glass Ceiling for the Women in Bangladesh Civil Service: An Overview", *24th World Congress of Political Science*, July 23-28, 2016, Istanbul, Turkey.

questions about the progress of public service. The study explored the impact of relevant factors, including current socio-cultural and economic changes in the country, on factors that may make gender differences in the choice of conflict management styles and measures of Bangladeshi managers.⁴⁰ The study extracted the causes of glass ceiling in the telecommunications industry in Bangladesh and finds that the career growth of female employees was significantly lower than that of men.⁴¹ The study analyzed the significance of different glass ceilings conducted in different Asian countries for more than three decades. The study found that the glass ceilings existed in the study included a multi-regional aspect that was classified regionally.⁴² Surveys and reports have shown that the employment rate in Bangladesh's banking sector decreased by 12.23% from 13.73% of the previous year's 2017.⁴³ The proportion of female executives who have reached higher positions shown a negligible figure obtained from the BIBM survey.⁴⁴ Central Bank of Bangladesh (BB) officials said that women workers did not come to the country through the newly launched bank.⁴⁵ The study was conducted on the basis of different issues of women and their status, socio-economic situation. A study designed to present the effects of the glass ceiling on job satisfaction and job decisions for private sector organizations such as banking and telecommunications in Bangladesh.⁴⁶ The study found that female employees in the banking sector were more satisfied than those in the telecommunications sector and also found that there was no significant correlation between glass ceiling variables with female employee job satisfaction, but overall significant statistically changes in glass ceiling factors about decisions. The reasons for the glass ceiling were concerned due to discrimination by their male colleagues, social insecurity, moving to higher positions and changing jobs for the better. Married female

⁴⁰ Sogra Kair Jahan "The Impact of Gender Differences on the Conflict Management Styles of Managers in Bangladesh: An Analysis", *Newcastle upon Tyne, UK: Cambridge Scholars Publishing*, 2014.

⁴¹ Laila Habib, "A Study of the Existing of Glass Ceiling in the Telecommunication Sector of Bangladesh. *Journal of Business and Management*, 2015, Vol. 17, Issue 12: 34-38, DOI: 10.9790/487X-171213438.

⁴² Senthil Arasu Balasubramanian, and Remya Lathabhavan, "Women's glass ceiling beliefs predict work engagement and burnout", *Journal of Management Development*, 36(10):00-00. DOI: 10.1108/JMD-12-2016-0282.

⁴³ Fakhruddin Mehedi and R.H. Sumon, "Women in the Banking Sector Fall Far Behind Men", *Observer*, 26 April 2017.

⁴⁴ [www.https://dailyasianage.com/news/58319/women-in-banking-sector-fall-far-behind-men](https://dailyasianage.com/news/58319/women-in-banking-sector-fall-far-behind-men).

⁴⁵ BB Official, "Many new banks are not recruiting women employees following Bangladesh Bank's order. That's why, the ratio of women bankers is not increasing", *The Asian Age*, 26 April 2017.

⁴⁶ Abdul Kader Nazmul, Nazrul Islam, and Md. Alam, "Glass Ceiling Factors, Job Satisfaction and Job Switching Decisions of Female Employees in Private Sector Enterprises of Bangladesh", *The Business Review*, 2016, Vol. 5:79-97.

employees were not willing to transfer the existing job. Another study was prepared to identify the glass ceiling issues and career barriers for female employees to communicate in RMG sector leadership positions in Bangladesh.⁴⁷ The study identified that women and employees were influenced by three ideological perspectives such as Bangladesh's organizational culture, social values and the lack of career counselors for leadership positions in the RMG sector in Bangladesh. The study showed the discriminatory position of female employees in the corporate sector in Bangladesh.⁴⁸ The survey emphasized that female employees have contributed to society but these positions were at a lower level. The study also identified the reasons for the unstable position of women in this male-led organization and suggested strengthening women's participation. The existence of glass ceilings is likely to create significant problems for researchers studying the judgment and decision-making process of top decision-makers, as a lack of women for such sampled results in selection bias that includes gender-based differences in professional judgment and decision-making. For example, research suggested that teams made up of more women are more productive and efficient which was relevant to the nature of team-based monitoring.^{49&50} The explicit /latent factor of glass ceiling in the Lebanese banking sector was studied based on middle and top level managers.⁵¹ The glass ceiling study area was not related to HRM practice in the banking industry. Bangladeshi and Pakistani women often expect to do a lot of housework which keeps them (women) away from organizational jobs. Fits compared to Bangladesh and Pakistan in terms of autonomy /women's movement in India.⁵² Female audit partners were more effective in mitigating their clients' earnings management efforts female analysts issue more accurate forecasts than male analysts and female CFOs are more likely than male

⁴⁷ Md. Asadul Islam, and Amer Hamzah Jantan, "The Glass Ceiling: Career Barriers for Female Employees in the Ready Made Garments (RMG) Industry of Bangladesh", *Academy of Strategic Management Journal*, 2017, Vol. 16, Issue 3, DOI: 10.1939-6104-16-3-141.

⁴⁸ Rifat Darina Kamal, and Amina Sabrin, "Gender Gap and Present State of Working Women in Corporate Arena: An Overview of Bangladesh Perspective", *Research on Humanities and Social Sciences*, 2014, Vol. 4 (10): 81-88.

⁴⁹ Anita Williams Woolley, Christopher F. Chabris, Alex Pentland, Nada Hashmi, and Thomas W. Malone, "Evidence for a Collective Intelligence Factor in the Performance of Human Groups", *Science*, 2010, 330, 686–688.

⁵⁰ Ken T. Trotman, Tim D. Bauer, and Kerry A. Humphreys, "Group Judgment and Decision Making in Auditing: Past and Future Research", *Accounting, Organizations and Society*, 2015, Vol. 47:56–72.

⁵¹ Dima Jamali, Assem Safieddine, and Maya Daouk, "The Glass Ceiling: Some Positive Trends from the Lebanese Banking Sector", *Women in Management Review*, 2006, Vol. 21 (8): 625-642.

⁵² Shireen J. Jejeebhoy, and Zeba A. Sathar, "Women's Autonomy in India and Pakistan: The Influence of Religion and Region", *Population and Development*, 2001, Vol. 27(4):687-712, DOI: doi.org/10.1111/J.1728-4457.2001.00687.x

CFOs to decide that shareholder values are higher.^{53&54} Similarly, studies relying on students or lower-level staff as proxies for high-level decision-makers will have problems with predictive validity, as those studies will not be able to control for real-world selection bias and low proportions of women that arise from the glass ceiling effect.

A study was conducted on job properties and individual outcomes of workers of a sugar mill and researchers tried to find out the factors that associated with job features. The study revealed the dependent variables like satisfaction, intrinsic work motivation and five independent factors (skill variety, task identity, task significance, autonomy and feedback) involved in JCM, policy making and organizational and individual improvement. The paper found that skill variety is significantly associated with personal outcomes, task identity, task worth, and benefits. The remaining core characteristics such as autonomy, feedback and administration policies and practices are shown having fewer significant effects on the personal outcomes. The article suggested to the management of the factory to enhance performance by giving immediate feedback to the concerned employees and modifying the administrative policies as well.⁵⁵

Another study was made among employees of public and private commercial banks operating in Bangladesh based on Job Diagnostic Survey (JDS) as stated by Oldham and Hackman. The researchers assessed the influence of demographics in the study, which found that there is a little high MPS of private bank than that of public bank in the study area. The study investigated the motivational differences in the work design of commercial bank according to designation, pay, age, experience, sex, mental condition, education level. Authors concluded that the properties of MPS are associated to a particular job unrelatedly to the demographics and the nature of the bank (Rahman & Nurullah, 2014).⁵⁶

⁵³ Alok Kumar, "Self-selection and the Forecasting Abilities of Female Equity Analysts. *Journal of Accounting Research*", 2010, Vol. 48, 393–435.

⁵⁴ Jiekun Huang, and Darren J. Kisgen, "Gender and Corporate Finance: Are Male Executives Overconfident Relative to Female Executives? *Journal of Financial Economics*, 2013, Vol. 108: 822–839.

⁵⁵ Aamir Ali Lashari, Imran Ahmed Shah, Sahira Malkawy and Shahdima Parveen, "Measuring the Factors Affecting Job Characteristics with Personal Outcomes (A Case Study of Khairpur Sugar Mill)", *Archives of Business Research*, November 2019, Vol. 7 (11):104-118, DOI: 10.14738/abr.711.7428.

⁵⁶ Md. Hasebur Rahman & Sheikh M. Nurullah, "A Comparative of Motivating Potential Score of Employees of Public and Private Commercial Banks: An Assessment of Demographics Influence", *Global Journal of Management and Business Research*, 2014, Vol. XIV, Issue IV, Version I:31-42.

A study was conducted on banks employees and attempted to evaluate the satisfaction level and productivity. The authors of the study stated that satisfaction depends on working conditions, pay, and work design and described based on the need-hierarchy, two factors and social influence group model of motivation. The researchers mentioned that there are two aspects regarding organizational variables such as occupational level, job content, managerial ship, interaction of a work group as well as personal variables such as age, education, experience, role perception etc.⁵⁷ An explorative research was done on employees of banking industries where authors tried to explore some factors related to job feelings in the study area. The researchers investigated to find out the levels of satisfaction of the participants and other influencing factors for the same. Elements including salary, performance evaluation tools, and promotional policies, employee affiliation with management, training and development method, work stress and working hours are the most significant factors for increasing job satisfaction. The paper identified some issues such as employees should be given more autonomy for responsible and organizational climate regarding OD initiatives can be rebuilt so that employee can contribute to the different issues of the bank.⁵⁸

A research work was organized on bankers designated at middle and upper level in Pakistan where the authors investigated the forecasters of job satisfaction. This study showed the positive correlation between job nature and personal outcomes like job satisfaction and high internal motivation. The authors in the study explained the correlation between JCM and growth needs strengths (GNS) and growth.⁵⁹

A study was conducted to measure the effectiveness of the financial and non-financial rewards granted to the bank employees with a view to motivating them for achieving the goals of the banks. The study also measured the level of satisfaction. The result of the study compared that there was a stronger effect of behavior regarding financial incentives on employee motivation and satisfaction than the attitudes towards

⁵⁷ Md. Minhajur Rahman and Md. Mukitul Hoque, "An analysis of Employee Job Satisfaction: A Study on United Commercial Bank Limited", *International Journal of ethics in Social Sciences*, December 2014, Vol. 2 (2).

⁵⁸ Aarti Chahal, Seema Chahal, Bhawna Chowdhury and Jyoti Chahal, "Job Satisfaction among Bank Employees: An Analysis of the Contributing Variables towards Job Satisfaction", *International Journal of Scientific & Technology Research*, August 2013, Vol. 2 Issue 8.

⁵⁹ Nadeem Bhatti, Anwar Ali Shah G. Syed, and F.M. Shaikh, "Job Satisfaction and Motivation in Banking Industry in Pakistan", *Journal of Asian Business Strategy*, 2012, Vol. 2 (3): 54-62.

non-financial incentives. The study found that there was a strong relationship between monetary and non-monetary rewards of the private banks in Saudi Arabia.⁶⁰ Another study analyzed the satisfaction level of employees in commercial banks and the result indicated that 66% (maximum) of employees were highly satisfied for their job security which had significant effect in case of non-monetary factor in the workplace. The satisfaction did not differ between male and female employees. The difference was identified in case of age groups of employees.⁶¹ The study explored the factors that how monetary and non-monetary rewards affect employee engagement and performance in developing countries. Linear regression was applied to forecast the outcome of rewards on firm performance facilitated through staff engagement. Results indicated the fact that monetary and non-monetary payments could escalate the level of employee commitment and high level of employee engagement was significant reason for a great firm's performance.⁶² Job satisfaction was examined by the effect of financial and non-financial motivational packages which was applied in food chain grounds and indicated the difference of employee behavior on some factors included in demographic characteristics of Turkey. Results indicated that there was a strong effect of those incentives on employee satisfaction. Financial rewards were higher than the effect of non-financial incentives regarding employee motivation.⁶³ The study assessed the effect of motivation on work satisfaction and performance of shipping companies in Taiwan. Four motivational dimensions such as remuneration, job achievement, job security and environment along with five dimensions of job satisfaction and organizational performance dimensions included financial and non-financial performance were used to exploratory analysis. Remuneration and job performance did have a positive effect on the dimensions such as return on assets (RoA), turnover growth rate and profitability included in financial performance. On the other hand, work environment and autonomy

⁶⁰ Maymonah Saleh Allahem, "The Impact of Monetary and Non-Monetary Rewards on Job Satisfaction: A Case Study of Saudi Bank in Qassim", 2019, www.eimj.org, Corpus ID: 210697694

⁶¹ Hari Prasad Pathak, "Job Satisfaction of Employees in Commercial Banks", *The Journal of Nepalese Business Studies*, 2015, Vol, IX: 63-73.

⁶² Zafarullah Waqas, and Sharjeel Saleem, "The Effect of Monetary and Non-Monetary Rewards on Employee Engagement and Firm Performance", *European Journal of Business and Management*, 2014, Vol.6: 73-82.

⁶³ Erbas Ali, and Tugay Arat, "The effect of Financial and Non-Financial Incentives on Job Satisfaction: An Examination of Food Chain Premises in Turkey", *International Journal of Business Research*, 2012, Vol. 5 (10): 136-145.

had a positive relation on the dimensions such as customer service, employee productivity and service quality involved in non-financial performance.⁶⁴ The study sought to demonstrate the effect of motivation in improving the productivity, provocation, and performance of employees in the HRM practices to achieve relevant dilemmas in the workplace. The results indicate that employees can take advantage of both high performance (past and future performance incentives) and do not enjoy relatively low efficiency incentive packages.⁶⁵ Only financial rewards do not highly affect the employee motivation and commitment but job related incentives have the role to play in inspiration as well as commitment of employees found in the organization.⁶⁶ A meta-analysis was conducted on the relationship between public service motivation (PSM) and different outcomes, including job satisfaction and result supported the hypothesis with mediating effect.⁶⁷ Employee motivation and its incentives affect organizational productivity. The productivity can be developed ensuing some elements such as employee job performance, engagement, innovation and creativity, commitment and loyalty, and ultimate job satisfaction. These elements should be provided while designing incentive packages and describe their activities and general effects.⁶⁸

Employees in the banks are considered as the pillar and most precious asset for handling operations. Satisfaction is the essential factor of employee life and it becomes the top issue in the banking sector. A study on identification the level of job satisfaction in banking industry in both private and public sector in Sri Lanka indicates higher level of satisfaction of public sector than the private sector bank employees. Ultimately it is found that salary is the greatest explanatory factor regarding job satisfaction of the

⁶⁴ Kelvin Pang, and Chin-Shan Lu, "Organizational Motivation, Job Satisfaction and Organizational Performance: An Empirical Study of Container Shipping Companies in Taiwan", *Maritime Business Review*, March 2018, Vol.3 (1):36-52, <https://doi.org/10.1108/MABR-03-2018-0007>.

⁶⁵ Mohammad Faisal Ahammad, Sang Mook Lee, Miki Malul, and Amir Shoham, "Behavioral Ambidexterity: The Impact of Incentive Schemes on Productivity, Motivation, and Performance of Employees in Commercial Banks", *Human Resource Management*, May 2015, Vol. 54(S1): s45-s62.

⁶⁶ Mukaram Khan, Anam Tarif, and Syed Sohaib Zubair, "Non-Financial Incentive System and Organizational Commitment: An Empirical Investigation", *Pakistan Business Review*, April 2016: 55-75.

⁶⁷ Fabian Homberg, Dermot McCarthy, and Vurain Tabvuma, "A Meta-Analysis of the Relationship between public service motivation and job satisfaction", *Public Administration Review*, 2015, Vol. 75(5):711-722.

⁶⁸ Jacqueline Aziri, "Employee Motivation Incentives and Their Impact on the Organization's Productivity", *Texila International Journal of Management*, Special Edition April 2019, DOI: 10.21522/TIJMG.2015.SE.19.01.Art007.

study. The other factors like work itself, job security, and recognition have the significant impact on job satisfaction.⁶⁹

Banks have been facing the challenges in the present scenario in relation to employee retaining since the commencement of huge number of banking organizations. Bank managers are to rethink about the rewards in order to get maximum output from employees. An explored the relationship between rewarding systems and employee outcomes of private banks and revealed that there was a significant relation between intrinsic and extrinsic rewards on employee performance. The extrinsic (financial) along with intrinsic incentives inspire the employees so that they can retain in the workplace for a longer period.⁷⁰

A self-conduct research was conducted by Karmasangsthan Bank in Bangladesh and focused on how motivational tools influence the individual performances with a better outcome. Findings of the study showed that the de-motivating factors affect negatively on performance of the employee. It has revealed that when employees were motivated they tried to apply highest effort improving effectiveness and finally goals are obtained with an easiest way. Banks can generate better outcomes through these motivational tools.⁷¹

At present, reasonable corporate atmosphere of the banking sector is to face a lot of challenges among the various issues, and one of the challenges is to get the right kind of employees and retain them. In order to obtain the highest result the banks should make the packages of lucrative and reward which affect employee motivation and satisfaction. A study was directed to observe the impacts of rewarding systems on satisfaction in the banks of Channei. The study emphasized on the readjustment of the HR strategies and rewarding

⁶⁹ IMS Weerasinghe, CJ Senawirathna, and HH Dedunu, "Factors Affecting to Job Satisfaction of Banking Employees in Sri Lanka Special Reference to Public and Private Banks in Anuradhapura District", *Business and Management Horizons*, May 2017, Vol. 5(1): 62-73.

⁷⁰ Ishtiaq Ahmed, and Sadia Shabbir, "The Effects of Rewards on Employee's Performance in Banks: A Study on Three Districts (Lodhran, Vehari, Khanewal)" Commercial Banks in Pakistan", *International Review of Management and Business Research*, March 2017, Vol. 6(1): 352-361.

⁷¹ Md. Nurun Nabi, Md. Monirul Islam, TanvirMahady Dip, and Md. Abdullah Al Hossain, "Impact of Motivation on Employee Performances: A Case Study of Karmasangsthan Bank, Bangladesh", *Arabian Journal of Business and Management Review*, 2017, Vol. 7(1), DOI: 10.4172/2223-5833.1000293.

policies for attaining the organizational goals, increasing motivation, performing their job better, enhancing satisfaction of employees in the banks.⁷²

There was a direct relationship between non-monetary incentives and job satisfaction and finally influenced the performance positively when a variety on non-cash incentives granted.⁷³ Non-monetary rewards are considered as the most significant tools in motivating employees and it was reported that 70% (significant portion) of employers applied non-financial awards in the organizations to retain them.⁷⁴

A research showed that the relationship between non-cash incentives and motivation of employee was a great complex matter. Study applied the tangible and intangible packages in the rewards systems to examine the effect of satisfaction and performance in the production settings and concluded that companies should add cash bonuses with the present pay. Non-cash rewards helped the lower level outputs of employees and mitigated the negative effects.⁷⁵ The non-financial rewards which have the significant contribution can increase performance as well as motivation than the financial rewards.^{76,77&78}

A study examined the impacts of extrinsic incentives on intrinsic motivation. Three predictors were developed such as engagement-contingent, completion-contingent and performance-contingent rewards by which intrinsic motivation undermined significantly. Tangible and intangible rewards were compared between the children and college students with a free choice behavior. The study found that tangible rewards were

⁷² Usha T. Priya, and T. Shakthi Eshwar, "Rewards, Motivation and Job satisfaction of employees in Commercial Banks- An Investigative Analysis", *International Journal of Academic Research in Business and Social Sciences*, April 2014, Vol. 4 (4): 70-78. www. Hrmars.com

⁷³ Alkhalil Adeep Abdullah, and Hooi Lai Wan, "Relationships of Non-Monetary Incentives, Job Satisfaction and Employee Performance", *International Review of Management and Business Research*, December 2013, Vol. 2, Issue 4: 1085-1091.

⁷⁴ D.M. Airoidi, "Employment Matters", *Incentives*, 2006, Vol. 180(8).

⁷⁵ ANN Dzurainin and Nathan Stuart, "The Effect of Tangible and Intangible Noncash Rewards on Performance and Satisfaction in a Production Setting", *Management Accounting Quarterly*, Summer 2012, Vol. 13(4), can be reached 815 and 920 respectively.

⁷⁶ Haseeb Riaz, Ch Akhtar, and Ramsha Aslam, "Total Rewards and Employee Performance: Investigating the Mediating Role of Employee Motivation in Telecom Sector. *Pakistan Administrative Review*, 2018, 2(3): 342-356.

⁷⁷ Dhanonjoy Kumar, Md Zakir Hossain, and Mst Shahnaz Nasrin, "Impact of Non-Financial Rewards on Employee Motivation", *Asian Auditing and Advancement*, 2015, 5 (1): 31-39.

⁷⁸ Shujaat Alam, Sobia, and Rafia Alam, "Impact of Non-monetary Rewards on Employees' Motivation", *Journal of Management and Social Sciences*, 2013, 9 (2): 1-5.

the most significant determinants for children than college students and verbal rewards tended to be less for the same choices.⁷⁹

Rewards may be either tangible or intangible which are the most important impact the employee satisfaction in their workplace. Study attempted to explore the relationship between tangible and intangible incentives and results showed there was a highly positive association with work satisfaction.⁸⁰ The best achievement of any organization is subject to the workers' commitment, creativity and motivation which lead to high level of satisfaction.

Managers should understand the importance of rewarding strategy in achieving goals because it increases the job satisfaction. A study analysed the association among rewards, job satisfaction and performance in the banking sector and found that reward had a strong support to job satisfaction. The other two impacts such as satisfaction and performance, and rewards and performance were not significantly associated. A balance should be established among the three factors included in HRM practices.⁸¹ Rewards either intrinsic or extrinsic are related positively to employee motivation showing significant effect found in the earlier studies.⁸²

Employee retention is referred to as a long-term employment in the organization. It might reflect the curiosity of an individual HR to work for a stable period of time in the organization.⁸³

⁷⁹ Edward L. Deci, Richard Koestner, and Richard M. Ryan, "A Meta-Analytic Review of Experiments Examining The Effects of Extrinsic Rewards on Intrinsic Motivation", *Psychological Bulletin*, November 1999: 627-668.

⁸⁰ Maryam Afridi, Marrium Shafi, Huda Munawar, and Sajid Mahmood Alvi, "Impact of Tabgible and Intangible Incentives on Job Satisfaction among Workers", *International Journal of Management Excellence*, 2016, Vol. 7(3):841-845.

⁸¹ Carmen-Elena Tanasescu and Romana-diana Leon, "Human Resources Practices in the Romanian Banking System: Rewards, Job Satisfaction, and Job Performance", *Management Dynamics in the Knowledge Economy*, 2019, Vol. 7, No. 4: 469-483; DOI:10.25019/MDKE/7.4.02.

⁸² Vera Akafo and Peter Agyekum Boateng, "Impact of Reward and Recognition on Job Satisfaction and Motivation", *European Journal of Business and management*, 2015, Vol.7, No. 24, www.iiste.org; C. Eshum& FK Duah, "Rewards as a Motivation Tool for Employee Performance", MBA Thesis (2014); Danish &Usman, "The Impact of Reward and Recognition on Job Satisfaction and Motivation: An Empirical Study from Pakistan", *International Journal of Business and Management*, February 2010, Vol.5(2); Z. Zakariaet el, "Reward Practice in Private Sector: Employees' Perception", *Interdisciplinary Journal of Contemporary Research in Business*, 2011, 2(12).

⁸³ Christopher Donoghue, "Nursing Home Staff Turnover and Retention: An analysis of National Level data", *Journal of Applied Gerontology*, 2010, Vol. 29 (1):91-101.

The retention has been regarded as the significant parameters for obtaining organizational goals especially in the competitive position. Organization may face loss when an employee leaves the organization or switches after receiving training. This is why; it should take measures so that an employee would like to stay in the organization permanently.⁸⁴

Training and retention can be defined as a structural process of developing knowledge, skills and abilities acquired by an employee to do better in his/her assigned tasks affecting the best performances. T & D permit personnel to receive opportunities that facilitate both organization and employees.⁸⁵

T&D helps to develop competitive advantage coping with changes resulting in higher commitment and loyalty leading to reduced turnover. It is true that employees have been searching for those kinds of organizations by which they might be trained up and developed so as to facilitate themselves making the better career planning. Retention may be increased and goals could be obtained when managers try to invest in developing employees. T&D should be given attention when there is a gap between present output and desired outcomes of organization and employee both. After receiving training an employee turns into a skilled and disciplined resource who can contribute to organizational performance. A study showed the effects of training on employee retention at Sudan Agricultural Bank training contributes to retention in the banks supported by majority and also revealed that working environment influences long-term employment.⁸⁶

A study was conducted on PCBs three dimensions aimed at identifying some dimensions regarding quality of work life (QWL) and retention strategy based on perception. The study signified the impact of organizational life on intention to stay. The

⁸⁴ Deepti Sinha, and Somesh Kumar Shukla, "A Study of Employee Retention in Pharmaceuticals Sector in Dehradun City", *International Journal of Education and Psychological Research (IJEPR)*, 2013, Vol. 2 (1):30-39.

⁸⁵ Eric Ng Chee Hong, Lam Zheng Hao, Ramesh Kumar, Charles Ramendran, and Vimala Kadiresan, "An Effectiveness of HRM Practices on Employee Retention in Institute of Higher Learning: A Regression Analysis", *International Journal of Business Research and Management (IJBRM)*, 2012, Vol. 3 (2): 60-79.

⁸⁶ Mohamed Rasha, Ngui Thomas Khatua and Malai Benjami, "Factors Determining Retention in the Banking Sector: A Case Study of Agricultural Bank of Sudan", *Journal of Education & Entrepreneurship*, 2017, Vol. 4: 1-23, <https://doi.org/10.26762/jee.2017.4000001>.

researchers empirically applied the dimensions like supervision, maintenance, flexibility, security, compensation as the string predictors associated with retention and QWL.⁸⁷

QWL indicates to job enrichment confirming job responsibilities affecting favorable or enjoyable work environment both for HR and organization increasing employee outcomes.⁸⁸ It receives the positive results for improving organizational outcomes like profit and productivity. The researcher examined the factors depending on how banking organizations design and execute work life balance, building good image, and ensure favorable work environment providing with permanent job, adequacy of rewarding and compensation, leave policy, fair treatment of employees, surety of tenure, opportunity for actualization, link between employee and organizational values and beliefs, good relationships with supervisors, overall satisfaction of bank policy and practices. The study showed by applying Probit Regression Model that those factors affecting employee retention of the banking industry.

A case study was applied on mid-low and suggested HR as a strategic partner for achieving competitive position. The study explored the variables regarding staff retention such as financial and non-financial opportunities, establishing a reward policy based on performance considering the proper training and promotion polices.⁸⁹ Another study investigated the factors of retention in banking industry of Karachi and concluded that there was a strong relationship between employees' motivation and retention and there was no high association between training and development. Researchers recommended modifying bank's policy of training and development for attracting and keeping employees.⁹⁰

Another study attempted to understand the effect of talent management strategy adopted by the public sector bank in India to take out the talent potential of its own

⁸⁷ M.M. Rahman, M. Abdul, N.A. Ali, J.M. Uddin and S.M. Rahman, "Employee Retention Strategy on Quality of Work Life (QWL) Dimensions of Private Commercial Banks in Bangladesh", *Social Sciences & Humanities*, 2017, Vol. 25 (2):647-662.

⁸⁸ Mohammad Jamal Uddin Rabb, Muhammad Fazlur, and Md Mizanur Rahman, "Quality of Work Life and Life Balance of Tea Workers", *Metropolitan University Journal*, 2015, Vol. 5 (1):55-70.

⁸⁹ Ekra Kabura Mwangi and Mary Omondi, "Factors Influencing Staff Retention in the Banking Industry in Kenya: A Case Study of Equity Bank Limited", *The Strategic Journal of Business & Change Management*, May 2016, Vol. 3, Issue 2 (20): 428-454. www.strategicjournal.com

⁹⁰ Atif Salman, Nawz Ahmed and Faiq Matin, "Factors Affecting on Employee Retention in Banking Sector: An Investigation from Karachi", *European Journal of Business and Management*, 2014, Vol. 6 (37): 169-178.

employees and it recommended that banks should follow some development initiatives such as: structured system periodic talent audit, need for future development performance related incentives like career planning, performance gap analysis, objective based feedback mechanism, counseled, self-defined target for little period etc..⁹¹

An empirical study was conducted on manufacturing (pharmaceutical) and service (banking) industry of mid-level employees in the station. The researchers attempted to correlate between HRD and job satisfaction and defined HRD as the facilitator of employees' ability by developing job rotation, enlargement. The findings of the study are indicative towards a growing developing need for an organization to make a healthy HRD to increase organizational effectiveness by which employees are satisfied and committed.⁹²

A study carried out on the state corporations of Kenya found that there was a strong correlation between work life balance and job autonomy and study showed the effect of organizational climate on employee performance and suggested that there should be ensured career development and work station with providing operations tools.⁹³ In another study a researcher explained that organization climate significantly affects psychological and organizational communication process, solution of the problem, motivation, learning, self-efficiency, and effectiveness of an organization.⁹⁴

A case study investigated the impact of organization culture on organization climate in the change and development process and showed how an organization culture influences organization climate through different change initiatives.⁹⁵ This study explored the factors such as adaptability, involvement of employees, strategic direction and plans, consisting with core values and integration which are the most significant

⁹¹ Ginji et al., "Talent Management- A Strategic HRD Initiative- A Case Study of a Public Sector Bank", *Indian Journal of Training & Development*, January-March 2012, Vol. XXXXII (1): 58-70.

⁹² Prashant Mishra, Upinder Dhar and Santosh Dhar, "Job Satisfaction As A Correlate of HRD Climate- An Empirical Study", *Indian Journal of Taraining & Development*, July-September 2013, Vol. 43 (3): 27-31.

⁹³ Naomi W. Githinji, and Hazed Gachunga, "Influence of Organizational Climate on Employee Performance in State Corporations in Kenya: A Case of Kenya Industrial Estates Limited", *The Strategic Journal of Business & Change Management*, May 2017, Vol. 4, Issue: 2 (22): 376-395.

⁹⁴ Zijada Rahimic, "Influence of Organizational Climate on Job Satisfaction in Bosnia and Herzegovina Companies", *International Business Research*, 2013, Vol. 6(3): 129-139.

⁹⁵ JurisIljims, Viktoija Skvarciany and ElinaGaile-Sarkane, "Impact on Organizational Climate Through Organizational Culture factors. Case Study of Latvia and Lithuania", *Trends Economics and Management*, 2015, Vol. IX, Issue: 24: 9-16.

factors of organization culture that influence the organization climate. A research article was conducted on organizational climate indicated the different ways rather than others.⁹⁶ Organizational climate should be treated from the holistic approach which is tolerable experienced standard by the team members. Many dimensions were analyzed to review the HRD climate. The dimensions are—autonomy, communication, co-operation, structure, conflict and its degree, management and leadership.

Researcher explored the predictor of work satisfaction from the study that organizational culture played role as a predictor of job satisfaction.⁹⁷ There were two significant dimensions such as leadership and performance appraisal used to observe the level of satisfaction and found positive correlation between organization climate and satisfaction.

A study examined the nature and HRD climate on Indian Commercial Banks resulting that there was a significant difference between public and private banks especially HRD instruments.⁹⁸ The study suggested the banks that should be conducted periodically between ‘HRD Climate’ and ‘Customer Satisfaction’ through surveying for obtaining constructive feedback so that HRD climate could be enhanced and rendering quality service to the customers. A simple model was developed for the practices of HRD philosophy creatively. Banks could develop feelings of ownership among employees and increase their commitment levels to successfully accomplish organizational goals. The researchers of the study justified the HRD climate variables i.e., OCTAPACE culture in the sampled banks.

Empirically studied on the executives of Indian state-owned enterprises whereas researchers explored that there were individual differences in taking decisions, all executives were forced by organization culture to cope with changes mediated by management style.⁹⁹

⁹⁶ M. Manika and K. Kaliyamurthy, “A Detailed Review of Organizational Climate”, *International Journal of Development Research*, July 2016, Vol. 6, Issue: 7: 8625-8633.

⁹⁷ Sanad A. Alajmi, “Organizational Climate and its Relationship to Job Satisfaction in Kuwaiti Industrial Companies”, *Asian Journal of Management Science and Economics*, 2016, Vol. 3(2):38-47.

⁹⁸ Srinivas Lakkoju, “HRD Climate in Indian Commercial Banks: A Comparative Study”, *Indian Journal of Training and Development*, July-September 2014, Vol. 44(3):32-43.

⁹⁹ Mudhumita Chatterji and MH Sharieff, “Influence of Organizational Culture on Decision Making in Selected Public Sector Enterprises”, *Ushus JB Management*, 2015, Vol. 14 (1):1-14.

An inquisitive investigation was carried out on the public and private organizations and it found that managerial effectiveness was affected by organization culture and suggested that a suitable atmosphere is required for smooth and remarkable output of the human resources.¹⁰⁰

Another study showed that productivity and reward differentiated between public and private banks and recommended that employees should be treated as a strategic partner because they are engaged in the execution of organizational strategic actions.¹⁰¹ This study was conducted based on employee output in the banking sector.

Management professionals elucidated that the most popular belief in Japan, the first country commenced to practice in corporations considered as “Better People” not merely technology was the unquestionable way to a “Better Society”.¹⁰²

Scholars and practitioners are attentive on how to cultivate HR through HRD which results organizational effectiveness. TV Rao, a pioneer of HRD Matrix that delineated HRD as fundamentally consists of three Cs: competencies, commitment, and culture.¹⁰³ All these three factors in HRD are required to brand an organization mission well. He clarified that without competencies an organization could not able to certify efficiency. Without commitment organization meets slowly pace development. The third one, culture repairs the organization to live long-time as oxygen to survive in the competitive arenas. It has been truly perceived by the researchers that an organization should come forward to esteeming human resources.¹⁰⁴

HRD referred as an approach originated on the trust that HRs is capable of growth - prearranged an environment that facilitates individual growth.¹⁰⁵ Growth is,

¹⁰⁰ Amjad Ali and Bhawasti Patnaik, “Influence of Organizational Climate and Organizational Culture on Managerial Effectiveness: An Inquisitive Study”, *The Carrington Rand Journal of Social Sciences*, June 2014, Vol. 1(2): 1-20.

¹⁰¹ B.S. Patil and H.R. Swapna, “Human Resources Development Practices and Employee Productivity in Banking Sector”. *Journal of Management value and Ethics*, April 2017, Vol. VII, www.researchgate.net

¹⁰² C.R Basu, “Human Resource Development”, *Indian Journal of Commerce*, Vol. XI (Jan-June 1987):150-151.

¹⁰³ T. V. Rao, *HRD Audit: Evaluating the Human Resource Function for Business Environment* (New Delhi: Response Books, 1999):17-18.

¹⁰⁴ R. P. Billimoria & N.K. Singh, *Human Resource Development* (New Delhi: Vikas Publishing House Pvt. Ltd, 1985): 3.

¹⁰⁵ Dayalshwar, *Designing HRD Systems* (New Delhi: Concept Publication Co., 1993): IV+116.

hence, imperative for an organization. HRD is involved in marking a person, a complete person in terms of skill, prime of life, competence, self-awareness, modification to the environment, and self-reliance.

Researcher states HRD that be seen as a philosophy rather than as a program. HRD is concerned with two sets of great factors - which prevents growth and which leads to growth.¹⁰⁶ In this relevance the study also signified that HRD as the process of aggregate knowledge, skills, capabilities and affirmative work approach and value of all HRs working at all levels in a business responsibility.¹⁰⁷ A study empirically conducted on the contributions of HRD efforts in the development of an economy. The study evaluated people as 'Human Capital' as well as 'Knowledge'.¹⁰⁸ The researcher mentioned in his article that empirically verifies the contributions of the 'HRD' efforts in the growth process of an economy. The author considered people as 'Human Capital' and 'Knowledge'. The essential for investment in the HRD is strongly correlated with the rate of technological advancement. The study described that higher rates of growth can be achieved by implementing sophisticated technologies in order to increase in the scale of production and operational complexities, the demand for highly qualified specialists and administrators also increase in the corporate world.¹⁰⁹ Study reviewed that the workers come in various forms from skilled to unskilled, professional to illiterate and old to young. Placing a worker in a job is only the first step in HRD. Moreover, HRD has been described as a journey towards higher level of performance.¹¹⁰ The study stated that training is an important factor of HRD which shyness to invest in the future talents. TV Rao signified strategically HRs so as to cope with the changes.

¹⁰⁶ Dayal Ishwar, "Current Perspectives and Future Issues: HRD in Indian Organizations", *Vikalpa*, October-December 1989, Vol.14:9-15.

¹⁰⁷ M.N. Khan, "HRD in Model Technological Structure", *Indian Journal of Commerce*, Jan-June 1987, Vol. XL No: 150-51: 83.

¹⁰⁸ T.R. Sharif, "Human Resource Development (HRD): In the Theory and Practice," *Journal of Business Administration*, IBA, DU, July & October, 1999, Vol. 25: 1.

¹⁰⁹ Iftekhar Ghani Chowdhury, "Human Resource Development: A competitive Perspective", *Journal of Business Administration*, IBA, DU, (July & October, 2003), Vol. 29:127.

¹¹⁰ Md. Abdul Mannan Chowdhury, (2003), "Human Resource Development and Economic Growth: A Critical Analysis with Special Reference to Bangladesh", *Insurance Journal*, Bangladesh Insurance Academy, July 2003, Vol. 54:149.

Consequently, job satisfaction is generated from the evaluation of employee performance.¹¹¹ There are different types of performance appraisal (PA) have been used to evaluate employee performance namely, management by objectives (MBO), 360-degree feedback, simple ranking, paired comparison, graphic rating scale, Behaviorally Anchored Rating Scales (BARS), Forced-Choice Rating Method etc. Through PA employees are confirmed about their efficiency. PA has also motivational effect on employees' behavior. PA is a motivational technique, which can be applied to enhance employee motivation and satisfaction.^{112&113} This is a way of controlling employee behavior in the organization as well.¹¹⁴ PA practices in organization can make decisions, which exhibit the current outcomes of employees.^{115&116} The main goal of PA is to attaining specified objective by applying human resource like as skill, experience, talent.¹¹⁷ It is the process of achieving, explaining as well as keeping records of information related to the worth of an employee behavior at work place. It is an effective tool of enhancing the effectiveness in the job place, which crucially develops and utilizes individual issues and competencies.¹¹⁸ By communicating, reviewing and discussion in any feedback session, an employee can be able to better understand his/her job responsibilities, which increases and develops efficiency toward obtaining goals of the banking organization. PA helps the banks especially to gain competitive advance. Performance of employees in the modern age of competitive in business organizations are rapidly changing and becoming more critical to success. And PA is the most significant sign of organizational goodness of fit as well.¹¹⁹

¹¹¹ M.M. Haque and A.M. Taher, *Affective commitment and its antecedents: An empirical study in the context of Bangladesh*. Paper presented at the 7th International Conference on Ethics and Quality of Work-life for Sustainable Development, 2008, Bangkok, Thailand. And in Mir Mohammed Nurul Absar, Mohammad Tahlil Azim, Nimalathasan Balasundaram, and Sadia Akhter, "Impact of human resources practices on job satisfaction: Evidence from manufacturing firms in Bangladesh," *Economic Sciences Series* 2010. 62 (2): 31-42.

¹¹² Chen, Jie, and Derek Eldridge, "Are —standardized performance appraisal practices really preferred? A case study in China. *Chinese Management Studies*, 4 (3): 244 –257.

¹¹³ Steven H. Appelbaum, Michel Roy, and Terry Gilliland, "Globalization of performance appraisals: theory and applications," *Management Decision*, 49 (4): 570 – 585.

¹¹⁴ A. Attorney, *Performance Appraisal Handbook* (New York: Nolo Publishers, 2007).

¹¹⁵ C.E. Gardner, "Employee evaluation: is it worth the effort?", *DVM*, 2008, 18 (5): 647-81.

¹¹⁶ J. Shields, *Managing Employee Performance and Reward*, (Cambridge: Cambridge University Press, 2007). <https://doi.org/10.1177/10384111080460010903>.

¹¹⁷ C.E. Gardner, "Employee evaluation: is it worth the effort?", *DVM*, 2008, 18 (5): 647-81

¹¹⁸ S Joubert and C.S Jonker, "Emotion work and well-being of client service workers within small and medium-sized enterprises", *Management Dynamics*, 2009, 18 (2): 35-48.

¹¹⁹ Tahir Ahmad, Faiza Farrukh and Sana Nazir, "Capacity building boost employee performance. *Industrial and Commercial Training*", 2015, 47 (2): 61-66.

A study was conducted empirically on how motivating techniques affect the performance of employees.¹²⁰ Findings show the positive attitude of employees improved their efficiency towards achieving goals of the banking organization. Researcher investigated the effect of rewarding on performance of employees in the manufacturing industry.¹²¹ The result got the significant effect of profit sharing on employee commitment and showed the negative impact employees' values in the manufacturing firms. Researchers explained in their study that the positive relationship of performance evaluation design and method (PEDM), and performance based reward does have insignificant effect on productivity of employees in the banking organizations.¹²² Another study explored money as much effective factor on performance and motivation than other variables such as promotion, security of the job, work environment, appraisal and other facilities.¹²³

Study identified that about 59% of MBO based, 43% of bi-annually, 31% of paired comparison, 17.24% of critical incident technique, 10.34% of alternative ranking, method PA practices in the service organizations of Bangladesh.¹²⁴ In the study, researchers found that the most significant reason of PA was to explore applicants 89% of promotion, 69% of pay raise, and 62.1% of training & development. It was also examined that about 69% of self-rating, 360-degree feedback, and rating committee. In the management change and development empirically proved that adoption of performance evaluation and reward systems.¹²⁵ With the upcoming changes performance management is to adopt for sustainable success especially in the public

¹²⁰ Srinath Parshetty, "Employee Motivation and Their Impact on Employee Performance in Banking Sector in Hyderabad Karnataka Region", *International Journal of Trend in Scientific Research and Development (IJRSRD)*, Vol. 3, Issue 4, 2019: 390-393.

¹²¹ Walters T. Ngwa, Bamidele S. Adeleke, Emmanuel K. Agbaeze, Nwanneka C. Ghasi, and Benedict O. Imhanrenialena, "Effect of Reward System on Employee Performance among Selected Firms in the Litoral Region of Cameroon", *Academy of Strategic Management Journal*, 2019, 18 (3): 1-16. Corpus ID: 19859340.

¹²² Chinedu Innocent Enekwe, Kenneth Nnagbogu Eziedo, and Charles Ikechukwu Agu, "Effect of Performance Appraisal on Employee Productivity in Nigerian Banking Sector", *International Journal of Research in Management Fields*, 3 (6), 2019. <https://doi.org/10.26808/rs.rmfv3i6.02>.

¹²³ Malik Muhammad Shafiq, and Muhammad Akram Naseem, "Association between Reward and Employee Motivation: A Case Study Banking Sector of Pakistan", *SSRN Electronic Journal*, June, 2011. <https://doi.org/10.2139/ssrn.1857663>.

¹²⁴ T. M. Azim, & M.M. Haque, "A Survey on Practices of Performance Appraisal in Bangladesh", *Journal of Business Administration, IBA, DU*, 2007, 33 (1&2): 89-113.

¹²⁵ Giovanni Azzone, and Tommaso Palermo, "Adopting Performance Appraisal and Reward Systems", *Journal of Organizational Change Management*, 2011, 24 (1): 90-111. <http://dx.doi.org/10.1108/09534811111102300>.

sector organizations. Studies confirm that different methods of appraisals and motivation do have different outcomes on motivation among employee. A study pointed out that rewards is the most significant indicator affecting satisfaction of existing employees.¹²⁶ In this case the study explained five identified context, namely rewards and incentives; ability to meet predetermined objectives; use of job description as performance benchmarks; help identify employee's strengths and weaknesses; and use of PA as promotional technique. Modern management can have the survival position in the today's competitive business field, only if they can make proper use of human capital as their most significant asset. It most important tasks of a HR manager due to its implication for the identification of employee capacity as well as taking decision on rewards. Study found that majority of the respondents were satisfied with PA system and rewarding practices in the organization.¹²⁷ A study explored factors of the long-term employment based on performance as well as the general environment of job affecting motivation of higher level executives.¹²⁸

The practices of multiple theories of motivation in different institutes were analysed by different researchers from their different views and contingencies. The present study has attempted to enhance more dimensions (pertaining to coverage) representing the employees' perception of motivation in the study area and of banking sector together and explore new factors for motivation determinants comprehensively relating to HRD outcomes of the banking organization. A special attention has given in the study to investigate the glass ceiling phenomenon influencing women motivation in the banks.

2.2 Research Gap

Several studies have conducted on the basis of job satisfaction, job characteristics and design, hygiene and motivational factors, QWL, training and development, retention in

¹²⁶ Ayomikun Idowu, "Effectiveness of Performance Appraisal System and Its Effect on Employee Motivation." *Nile Journal of Business and Economics*, 2017, 3 (5): 15. <https://doi.org/10.20321/nilejbe.v3i5.88>

¹²⁷ Sabnam Jahan, "Employee Performance Appraisal System: A Study on Square Pharmaceuticals Limited", *Dhaka University Journal of Business Studies*, 2016, XXXVII (1):47-61

¹²⁸ SK. Tasthekur Hossain Kowshik, Samia Shabnaz, Stanley Sumon Rodrick, "Relationship of individual factors and HRM practices on employee retention in private banking sector of Bangladesh. *Eighth International Conference on Advances in Economics, Management and Social Study-EMS*. <https://doi.org/10.15224/978-1-63248-145-7-17>. In *Organizational Factors Affecting Employees Retention: A Study on Private Commercial Banks of Bangladesh*. *International Journal of Business and Management Study*, 4 (1):19-24.

home and across the world and in the academic arena. Some researchers have done based Maslow's Need Hierarchy Theory, Two Factor Theory of Motivation separately. On the other hand, many scholars reviewed the theories of motivation in a single unit. The contingency or content models such as reinforcement, equity, expectancy, and goal setting theory related to motivation which has been viewed theoretically as well as pragmatically. Some of the researchers have carried out the studies individually and compared to two models.

Researchers have given attention to the financial, non-financial factors followed to enrich job performance from different aspects. Besides, the additional benefits such as fringe benefits, job security, leave facilities, after retirement facilities, etc. are highlighted in the field of study individually and even separately. Many studies have been developed on the basis of demographic factors like age, experience, salary, designation etc. Academic and researchers perceived organizational culture, HRD climate, organizational effectiveness (TV Rao, 1990) that are related to employee motivation and satisfaction and explained different facets.

All the previous studies found in the literature review have focused on job satisfaction, benefits, motivation, from the different dimensions and mechanisms to have impact on employee behaviour leading to job performance. But no study could reflect or shed over the entire environment that can be used to settle down employee motivation or motivated behaviour through job satisfaction connected to HRD mechanisms, HRD outcomes, climate/OCTAPACE and organizational effectiveness as determinants. The researcher viewed no composite observation and latent factors just like an iceberg to motivate employee in the literature review. So, there is an ample scope to work with the proposed study.

From the previous researchers gained valuable knowledge in the field of organizational culture, HRD practices, different theories, job criteria, strategic management practices regarding job satisfaction and motivation that will be helpful as the ground work in the present study.

Apart from this, no study has been found by the researcher that reflected a complete picture matches with the focus of the researcher intended to employee motivation

through job satisfaction in the banking sector (public and private) of Bangladesh. Thus, current study does have the opportunity to expand more concentration and new knowledge in the field of motivation and human resource development through the exploration of employee and organizational outcomes. For such a call, the researcher attempted the present study titled ‘Employee Motivation and Human Resource Development in the Banking Sector of Bangladesh: Theories and Practices.’

2.3 Research Questions

Table 2.1: Lens of the study framework for key concentrated areas

Specific questions	Key Areas
1. Is employee satisfaction influenced by gender?	(A) Employee satisfaction influenced by demographic factors
2. Is employee satisfaction influenced by marital status?	
3. Is employee satisfaction influenced by designation?	
4. Is employee satisfaction influenced by type of bank?	
5. Is employee satisfaction influenced by location?	
6. Is employee satisfaction influenced by experience?	
7. Is employee satisfaction influenced by increment?	
8. Is employee satisfaction influenced by gross salary?	
9. How much level of satisfaction exists among employees?	(B) Satisfaction existing in the banks
10. How does job satisfaction exist in public and private bank?	
11. What is the most effective indicator influencing employee motivation?	
12. Do the job characteristics influence employee motivation?	(C) Effect of JCM and DFs
13. What are the relationships of MPS and demographic factors (DFs) regarding employee motivation?	
14. Is motivation influenced by gender?	(D) Demographic factors influence motivation
15. Is motivation influenced by marital status?	
16. Is motivation influenced by designation?	
17. Is motivation influenced by types of bank/nature of bank?	
18. Is motivation influenced by location?	
19. Is motivation influenced by banking diploma?	
20. Is motivation a influenced by experience?	
21. Is motivation influenced by types of increment?	
22. Is employee motivation affected by glass ceiling?	(E) Impact of Content/Motivation Theory
23. Is employee motivation influenced by hygiene factors?	
24. Is employee motivation influenced by motivating factors?	
25. Is employee motivation influenced by Two-Factor?	(F) Effect of FBs and OMBs
26. Is employee motivation influenced by financial benefits?	
27. Is employee motivation affected by other monetary benefits?	(G) Motivation
28. Is employee motivation influenced by job security?	

Specific questions	Key Areas
29. Is employee motivation influenced by leave policy?	affected by FNBS
30. Is employee motivation influenced by fringe benefits?	
31. Is employee motivation influenced by QWL?	(H) Motivation influenced by HRD environment
32. Is employee motivation influenced by training?	
33. Is employee motivation influenced by retention?	
34. Is employee motivation influenced by HRD environment?	
35. Is retention signified by HRD environment?	
36. What contributes of HRD to banks?	
37. Is motivation influenced by HRD mechanisms or instruments?	
38. Is employee motivation influenced by HRD process variables?	
39. Is motivation influenced by OCTAPACE or HRD climate?	
40. Is employee motivation influenced by individual outcomes?	
41. Is employee motivation influenced by performance appraisal (PA)?	
42. Is employee motivation influenced by management practices (Mgt Practices)?	
43. Is employee motivation influenced by organizational effectiveness?	
44. What contributes HRD in the banking sector of Bangladesh?	

2.4 Overall Functional Equation of Employee Motivation in the Banks

Functional relationship has been constructed with the following factors of employee motivation and HRD practices.

$$\text{Employee Motivation} = \alpha + \beta_1 (\text{JCM}) + \beta_2 (\text{Financial Benefits}) + \beta_3 (\text{Other Monetary Benefits}) + \beta_4 (\text{Fringe Benefits}) + \beta_5 (\text{Leave Benefits}) + \beta_6 (\text{Glass Ceiling}) + \beta_7 (\text{Ergonomics/QWL}) + \beta_8 (\text{Training and Retention}) + \beta_9 (\text{HRD environment}) + \beta_{10} (\text{HRD Mechanisms}) + \beta_{11} (\text{HRD Process}) + \beta_{12} (\text{OCTAPACE or HRD Climate}) + \beta_{13} (\text{PA}) + \beta_{14} (\text{Management Practices}) + \beta_{15} (\text{Organizational Effectiveness: Employees and Organizational Outcomes}) + e.$$

2.5 Objectives of the Study

The main objective of this study is to extract the motivational issues from the different motivation theories and relate with Human Resource Development (HRD) Matrix as well as evaluate its practices in the banking sector of Bangladesh. With a view to achieving the main objective, the following specific objectives have been taken under consideration:

1. to extract the motivational issues from motivation theories and to assess human resource development (HRD) Matrix in depth;
2. to examine the demographic composition and glass ceiling phenomenon with the employee motivation issues;
3. to determine the factors of motivation which influence the level of satisfaction among the employees;
4. to investigate the influence of employee benefits on motivation;
5. to find out the effect of employee training and retention on motivation;
6. to explore the effective factors of quality of work life and HRD environment influences employee motivation;
7. to examine the effect of HRD outcomes and organizational effectiveness on employee motivation; and
8. to suggest measures for enhancing employee motivation.

Chapter Three

Research Methodology

3.1 Nature of the Study

This study is based on of quantitative approach complemented by some qualitative obseravtion. The design and questionnaire of the study and all the objectives were based on quantitative assessment of employee perception in banks. Thus, the researcher has used quantitative methods to achieve the optimum goal according to research objective. In this study, the Simple Random Sampling (SRS) method was used to select individual employee from each bank branch for both public (state-owned) and private banks in the study area.

3.2 Selection of Study Area

The practice of HRD in banking sector of Bangladesh is more or less same. Employee motivation and human resource development strategies, policies and practices of the branches of various government and private banks are almost same all over the country as they are run and operated centrally by their head office/governing bodies. So, data collection and analysis from any one division of Bangladesh can produce the same scenario on the research objectives that can also be statistically significant as it covers more than 1/10th of the country. Simple Random Sampling technique (SRS)¹ has been used to select the research area, whereby Rangpur division is picked-up from lottery. With a view to getting insights to the study has been applied stratified random sampling method.² Banking sector of Bangladesh is operating in the eight administrative divisions. The scheduled banks located in seven districts i.e., Rangpur, Dinajpur, Kurigram, Lalmonirhat, Thakurgaon, Panchgar, and Nilphamari are being monitored by Bangladesh Bank (BB) Rangpur Office. Another one district (Gaibandha) having its scheduled banks are being monitored by Bangladesh Bank (BB) Bogura Office. The branches of the different banks have been selected through Simple Random Sampling

¹ William G. Cochran, *Sampling Techniques*. New York: John Wiley & Sons, 1977.

² Mohammad Al-Jabari, "Factors Affecting Human Resource Practices in a Sample of Diversified Palestinian Organizations", *Tourism & Management Studies* (2013): 594-603.

(SRS) using MS Excel 2013 as well. The study area is covered the banks and branches of Rangpur, Dinajpur and Nilphamari districts under Rangpur division which are also selected through SRS and fulfilled the condition of representativeness as the three districts covering more than 30% (NB).³

3.3 Sample Size Determination and Distribution of Branches and Respondents

The total number of branches in the study area (three districts) is 359 (N) which is considered as study population. Out of 359 branches, the required number of sample branches (n_0) has been selected using Simple Random Sampling. The sample unit (n_0) is determined by the following formula:⁴

$$n_0 = \frac{z^2 pq}{e^2} \text{----- (1); where, } n_0 \text{ is the sample size of branches,}$$

Z is the standard normal value corresponding to the desired level of confidence (95%), e is the acceptable margin of error (.08) as the researcher accepted the larger (10%) error margin in case of qualitative research.⁵ p is the estimated proportion of an attribute that is present in the population, and q is 1-p (the estimated proportion of an attribute that is not present in the population). The value for Z is found in statistical tables which contain the area under the normal curve. $n_0 = \frac{z^2 pq}{e^2} = \frac{(1.96)^2(.5)(.5)}{(.10)^2} = 96$, so, required number of sampled branches is 96 (n_0). The sample obtained using the formula (1) known as population ($N=359$)⁶ was found in 96 branches and it covers $n_0/N=96/359*100=26.75\%$ followed by stratified random sampling. Thus, the sample branches (n_0) 96 of the selected banks from the study area. Four (4) employees were selected as respondents or participants from the ten selected banks using equal allocation from each branch. Therefore, the total number of respondents/ participants is $(96*4) = 384$. In addition, four divisional offices (SBL, JBL, ABL and RAKUB) in Rangpur of the public banks are selected and 4 employees were preferred as participants from each office for rounding up 400. So, the

³ Nota Bene, Operating in six districts from them three has been selected, i.e., $3/6= 50\%>30\%$.

⁴ William G. Cochran, *Sampling Techniques*, 3rd Edition (New York: John Wiley & Sons, 1977): 75.

⁵ The Bangladesh Report: "Report of Survey Findings and Qualitative Study Results from a Factory in Chittagong," *Levi Straus & Co., Workers' Well-being Study* (December, 2013): 1-37. <http://levistrauss.com/wp-content/uploads/2014/01/Workers-Well-Being-Study-Bangladesh-.pdf>. (accessed on 11.08.2017).

⁶ Bangladesh Bank (BB), Rangpur Office, February 2018.

ultimate respondents/ participants are $N = (96 \times 4) + (4 \times 4) = (384 + 16) = 400$ employees (required sample size).

Table 3.1: Sample size determination and sample distribution

Dist.	Branches (all) **	Name of the Banks	No. Branches (n)	Branch ^{***} (n_0/N)*n	Respondents [@]
Rangpur : (n=166; 41.5%)	$N_1=132$ Proportion= $n_i = \frac{N_i}{N} \times n_0 =$ $(132/359) \times 96$ $= 35$	Sonali Bank Ltd.	21	8 (7.72)	41
		Janata Bank Ltd.	16	6 (5.88)	32
		Agrani Bank Ltd.	14	5 (5.15)	26
		RAKUB ^{****}	33	9 (11.03)	37
		Pubali Bank Ltd.	4	2 (1.5)	5
		Uttara Bank Ltd.	2	1 (0.7)	5
		National Bank Ltd.	2	1 (0.7)	5
		DBBL ^{*****}	1	1 (0.4)	5
		Prime Bank Ltd.	1	1 (0.4)	5
		BRAC Bank Ltd.	1	1 (0.4)	5
Dinajpur (n=171; 42.8%)	$N_2=154$ Proportion= $n_i = \frac{N_i}{N} \times n_0 =$ $(154/359) \times 96$ $= 41$	Sonali Bank Ltd.	33	9 (14.16)	39
		Janata Bank Ltd.	17	7 (7.29)	32
		Agrani Bank Ltd.	18	7 (7.72)	30
		RAKUB	41	9 (17.59)	38
		Pubali Bank Ltd.	4	2 (1.72)	7
		Uttara Bank Ltd.	4	2 (1.72)	6
		National Bank Ltd.	3	2 (1.29)	5
		DBBL	1	1 (0.43)	5
		Prime Bank Ltd.	1	1 (0.43)	4
		BRAC Bank Ltd.	1	1 (0.43)	5
Nilphamari(n=63; 15.8%)	$N_3=73$ Proportion= $n_i = \frac{N_i}{N} \times n_0 =$ $(73/359) \times 96$ $= 20$	Sonali Bank Ltd.	10	3 (2.03)	15
		Janata Bank Ltd.	8	3 (1.63)	13
		Agrani Bank Ltd.	4	2 (0.82)	10
		RAKUB	22	4 (4.47)	7
		Pubali Bank Ltd.	3	2 (0.61)	3
		Uttara Bank Ltd.	2	2 (0.41)	3
		National Bank Ltd.	1	1 (0.2)	3
		DBBL	1	1 (0.2)	3
		Prime Bank Ltd.	1	1 (0.2)	3
		BRAC Bank Ltd.	1	1 (0.2)	3
Total	$N_1 + N_2 + N_3 = 359$		$(92+123+53) = 268$	$(35+41+20) = 96$	$(96 \times 4) + (4 \times 4) = 400$

* Sample branches (n_i) from the sampled banks' branches is calculated by the following formula, $n_i = \frac{N_i}{N} \times n_0 = (132/359) \times 96 = 35$ (Rangpur), $(154/359) \times 96 = 41$ (Dinajpur) and $(73/359) \times 96 = 20$. Sampled Branches have been selected by $n_j = (n_0/N) \times n$ i.e., $(96/359) \times 21 = 7.72 = 8$. Participants/ respondents are selected by using equal allocation based on branches. Disproportionate/ non-proportionate stratified sampling.

** Source: Bangladesh Bank, Rangpur Office, February 2018. *** All the sample branches have been selected randomly (random number method) from the source branches. All of the branches of the sampled banks which are very few in number have been taken as sample. Therefore, the sample bank which are more have been reduced slightly to adjust the fewer number of bank branches, i.e., @ Since the number of employees or respondents is unknown so it has been considered that 4 (using equal proportional allocation) employees as respondents or sample units from the selected branches. **** RAKUB stands for Rajshahi Krishi Unnayan Bank, and ***** DBBL stands for Dutch-Bangla Bank Limited.

⁷ $(4 \times 4) = 16$ participants are selected from the Rangpur Divisional Offices of the four public banks (SBL, JBL, ABL and RAKUB) for rounding up 400 participants.

Table 3.2: Distribution of 400 employees among ten banks

District	SBL	JBL	ABL	RAKUB	PBL	UBL	NBL	DBBL	PrBL	BRAC	Total	
Rangpur	41	32	26	37	5	5	5	5	5	5	166	
Dinajpur	39	32	30	38	7	6	5	5	4	5	171	
Nilpham	15	13	10	7	3	3	3	3	3	3	63	
Total	95	77	66	82	15	14	13	13	12	13	400	
Percent	23.8	19.3	16.5	20.5	3.8	3.5	3.3	3.3	3	3.3	100.0	
District	Rangpur 41.5%				Dinajpur 42.8%				Nilphamari 15.8%			

3.4 Sources of Primary and Secondary Data

Required number of employees (N=400) of the selected branches of the ten banks has been interviewed irrespective of male or female through structured questionnaire survey. The employees working in the different branches ($n_0=96+4=100$) of the banking industry are considered as the main sources of the primary data. The sources of secondary data have been collected from the different publications of Bangladesh Bank, Training/Academic Institutes of the four public and six private banks, relevant reports of the sampled banks, articles, annual reports, dailies, journals, books, government gazettes, dissertations, academic books and various websites.

3.5 Primary Data Collection

Primary data have been collected through self-administered questionnaire survey, and observation. The questionnaire contains the open and close ended questions. In some cases 5 points Likert's Scale is used.⁸ Pre-testing procedure is followed for designing the final questionnaire. The data were collected upto December 2019 from the selected ten banks.

3.6 Data Analyzing Techniques

Frequency distribution, descriptive statistics along with inferential statistics such as bivariate correlation, Chi-square Test of Fisher's Exact *p*-value, Levne's Variance Equality Test for comparison, Linear Regression Model, ANOVA, P-P, Q-Q, and Scree Plots, Exploratory Factor Analysis (EFA: KMO and Bartlett's Test of Sphericity), Total Variance Explained, Structural Equation Modeling (SEM), considering single and double latent factors. With a view to confirmatory factor analysis (CFA) SEM has been constructed for exploring the effective factors. In some cases, primary data were

⁸ Rensis Likert, "A Technique for the Measurement of Attitudes," *Archive of Psychology*, Vol-22 (1932): 5-55

collected from participants through direct perceptions such as ‘yes’, ‘no’ and ‘something’ for Binary Logistic Regression. Five Point Likert’s Scale used and designed the questionnaires for assembling data from the participants.^{9&10} Logistic regression have been used due to outcome variable (yes=1 and no=0) dichotomous.¹¹

3.7 Statistical Analysis of the Research Methodology

Association Studies

X_1, X_2, \dots, X_r are the r - category of the attribute X and Y_1, Y_2, \dots, Y_c are the c - category of the attribute Y. O_{ij} is the observe frequency of i^{th} category of X and j -th category of Y and N is the grand total.

For testing the hypothesis

H_0 = There is no association between X and Y.

H_1 = Null hypothesis is not true.

Test statistic is

$$\chi^2 = \sum_i \sum_j \frac{(O_{ij} - E_{ij})^2}{E_{ij}} \sim \chi^2_{(r-1)(c-1)}$$

Where,

E_{ij} =The expected number of respondent in the $(i,j)^{\text{th}}$ cells.

O_{ij} = number of respondent at the i^{th} row and j^{th} column of respective contingency table.

r = no. of rows, and c = no. of columns.

We know that the null hypothesis might be accept at the 5% level of significance, if the 2-sided asymptotic significance level is less than. 0.05, otherwise the null hypothesis is may be rejected. For this particular problem, we observe that the null hypothesis is might be accepted at the 5% level of significant when the Pearson’s Chi-square test is used.

⁹ M.M. Haque, and M.T. Azim, “Affective commitment and its antecedents: An empirical study in the context of Bangladesh”, Paper presented at the 7th International Conference on Ethics and Quality of Work-life for Sustainable Development, 2008, Bangkok, Thailand.

¹⁰ Bonnie Bei Yu, and Carolyn P. Egri, “Human resource management practices and affective organizational commitment: A comparison of Chinese employees in a state-owned enterprise and a joint venture”, *Asia Pacific Journal of Human Resources*, 2005, Vol. 43 (3): 332-360.

¹¹ Chao-Ying Joanne Peng, Kuk Lida Lee, and Gary M. Ingersoll, “An Introduction to Logistic Regression Analysis and Reporting”, *The Journal of Educational Research*: 2002, Vol. 4, DOI: 10.1080/0020670209598756.

F-Test

The F-test is used to compare variances. One can use it to determine if two data sets come from the same distribution or if a single data set matches a known underlying distribution. The F statistic is:

$$F = \frac{\hat{\sigma}_1}{\hat{\sigma}_2}$$

Where $\hat{\sigma}_1$ is the standard deviation calculated from one data set and $\hat{\sigma}_2$ is the standard deviation calculated from the other data set.

The p- value Calculation

The p-value can be calculation formula can be defined as:

$$p - value = Pr(T \leq - |t| | null Hypothesis) + Pr(T \geq - |t| | null Hypothesis)$$

If, p-value < 0.05 then Null Hypothesis (H_0) rejected at 5% level of significance

and p-value < 0.01 then Null Hypothesis (H_0) rejected at 1% level of significance

The Model of Logistic Regression

Logistic regression analysis is the most popular regression technique for modeling bi-dependent variables. Logistic regression is a mathematical modeling method that can be used to describe the relationship of different predictive variables such as X_1, X_2, \dots, X_k to a dichotomous ('yes' or 'no') dependent variable Y. Let's try to write the model as:

$$Y = \beta_0 + \sum_{j=1}^k \beta_j X_j + \varepsilon$$

Let Y is a dependent variable, which take value 1, 2 then,

$$Y_i = \begin{cases} 1, Yes \\ 0, NO \end{cases}$$

Where, $i = 1, 2, \dots, n$. Also consider a collection of k independent variables which will be denoted by the vector $X' = (X_1, X_2, \dots, X_k)$ and β be a $(K + 1) \times 1$ vector of unknown parameters.

For simplification, researcher has used the quantity $\pi(X) = P(Y = 1|X)$ the probability that the event occurs conditional on the value of X.

$$Z^w = \frac{SE(\hat{\beta}_j)}{\hat{\beta}_j} \quad ; \quad \text{under } H_0: \beta_j = 0$$

Following test statistic

An alternative test for the significance of the coefficients in the Wald test which uses the

Wald Test:

If $\chi^2_{2} > \chi^2_{(d-1), \alpha\%}$ then we reject $H_0: \beta_1 = 0$ otherwise we accept $H_0: \beta_1 = 0$.

Decision Rule

square with $(d - 1)$ degrees of freedom.

$\beta_1 = 0$. If the hypothesis $H_0: \beta_1 = 0$ is true then χ^2 is asymptotically distributed as chi-

Where, the first term is the maximized log likelihood subject to the constraint

$$\chi^2 = -2 \left[\ln L(\hat{\beta}_0, 0, \hat{\beta}_2, \dots, \hat{\beta}_d) - \ln L(\hat{\beta}_0, \hat{\beta}_1, \dots, \hat{\beta}_d) \right]$$

For example- to test $H_0: \beta_1 = 0$ against $H_1: \beta_1 \neq 0$ we use the test statistic-

To test the hypothesis that some of the β_j 's are zero, a likelihood ratio test can be seen.

Hypothesis Testing

$Z_{\alpha/2}$ is the $100 \left(\frac{\alpha}{2} \right)$ percentile of the standard normal distribution.

The approximate $100(1 - \alpha)$ percent confidence interval for β_j is $\hat{\beta}_j \pm Z_{\alpha/2} \sqrt{I_{jj}^{-1}}$ where

Confidence interval of β_j

$$OR = \frac{\exp(\beta_0 + \beta_1 x_1 + \dots + \beta_j x_j + \dots + \beta_d x_d)}{\exp(\beta_0 + \beta_1 x_1 + \dots + \beta_j x_j + \dots + \beta_d x_d)}$$

effective factors):

as the ratio of the odds for $x_j = 1$ to the odds for $x_j = 0$ and is given by, (for finding

We assume that x_j takes value 0 and 1, and then the odds ratio denoted by OR is defined

the simplest case and will provide the conceptual foundation for all the other situations.

Now we consider the situation where the dependent variable is dichotomous. It is

$$P(Y = 1 | X) = \pi(X) = \frac{e^{\beta_0 + \beta_1 x_1 + \dots + \beta_j x_j + \dots + \beta_d x_d}}{1 + e^{\beta_0 + \beta_1 x_1 + \dots + \beta_j x_j + \dots + \beta_d x_d}}$$

$$Y_2 = A_{21}F_1 + A_{22}F_2 + U_2 ; \quad Y_4 = A_{41}F_1 + A_{42}F_2 + U_4$$

$$Y_3 = A_{31}F_1 + A_{32}F_2 + U_3 ; \quad Y_1 = A_{11}F_1 + A_{12}F_2 + U_1 ;$$

Factors (F's) are as follows:

Factor Analysis Equations: Suppose, there are identified two factors that account for responses of four different items. Suppose the relationships between items (Y's) and

$$R^2 = \frac{\left(\sum X_{22} - n\bar{X}_2\right)\left(\sum Y_2 - n\bar{Y}_2\right)}{\left(\sum XY - n\bar{X}\bar{Y}\right)^2} = \frac{SS_x SS_y}{S_{xy}^2}$$

determination formula can be written as,

R²: For justification of the Fitting Multiple Regression Model the coefficient of multiple

Also, it can be written as, $r = \frac{S_{xy}}{\sqrt{SS_x} \sqrt{SS_y}}$.

Where, $SS_x = \sum X_{22} - n\bar{X}_2^2$, $SS_y = \sum Y_2 - n\bar{Y}_2^2$ and $S_{xy} = \sum XY - n\bar{X}\bar{Y}$

$$r = \frac{\sqrt{\sum X_{22} - n\bar{X}_2^2} \sqrt{\sum Y_2 - n\bar{Y}_2^2}}{\sum XY - n\bar{X}\bar{Y}}$$

defined as

Pearson Correlation Coefficients: The simple sample correlation coefficient can be

X's is the independent variables

β_0 is the intercept term; ϵ 's be the random error; Y is the dependent variable and

Where, β 's are regression coefficients

$$Y = \beta_0 + \beta_1 X_1 + \beta_2 X_2 + \beta_3 X_3 + \beta_4 X_4 + \beta_5 X_5 + \beta_6 X_6 + \dots + \epsilon$$

model as an explanatory variable as a problem:

Multiple linear regression has been used to examine the average relationship between the dependent variable and independent variables. It measures the dependency by the effect of explanatory variables or independent variables. The study a regression

Multiple Regression Analysis

A two sided test would reject $H_0: \beta_j = 0$ if $|Z_w| < Z_{\alpha/2}$. Otherwise we accept $H_0: \beta_j = 0$.

Where Z_w follows the standard normal distribution.

Above, the letter, λ , is to load an item on a factor where λ , is used as the loading symbol). Loadings represent the degree to which items are related. In some analyzes they are literally interrelated coefficients. In other analyzes these are equal to the partial regression coefficients. In both cases, they tell us how the item is associated to the factor.

$A_{\text{item, factor}}$: The first subscript is the item, the 2nd the factor.

The “U”s the above a unique sources of specific variations for the items. Some of the variations are specific to this particular item, for example the presence of a strange word in this and only this item. The other unique variant is unobserved, the random variant- measurement error.

On the upside, the common causes of F’s are called common factor since they are general among four variables. As mentioned above, many people see these as individual traits. Thus, above, the variation of the two ‘F’ determines the variation of the four (4) items. There is a complication in case of reduction. Researchers can only be composed for 4 different reasons. Similarly similarly researchers can proceed for more than 4 reasons

3.8 Conceptual Framework of the Study

The study is covered the following variables mentioned in the Figure 3.1 that are extracted from the different behavioral theories of motivation as well as HRD Matrix in management. The researcher has conducted the study based on the following framework.

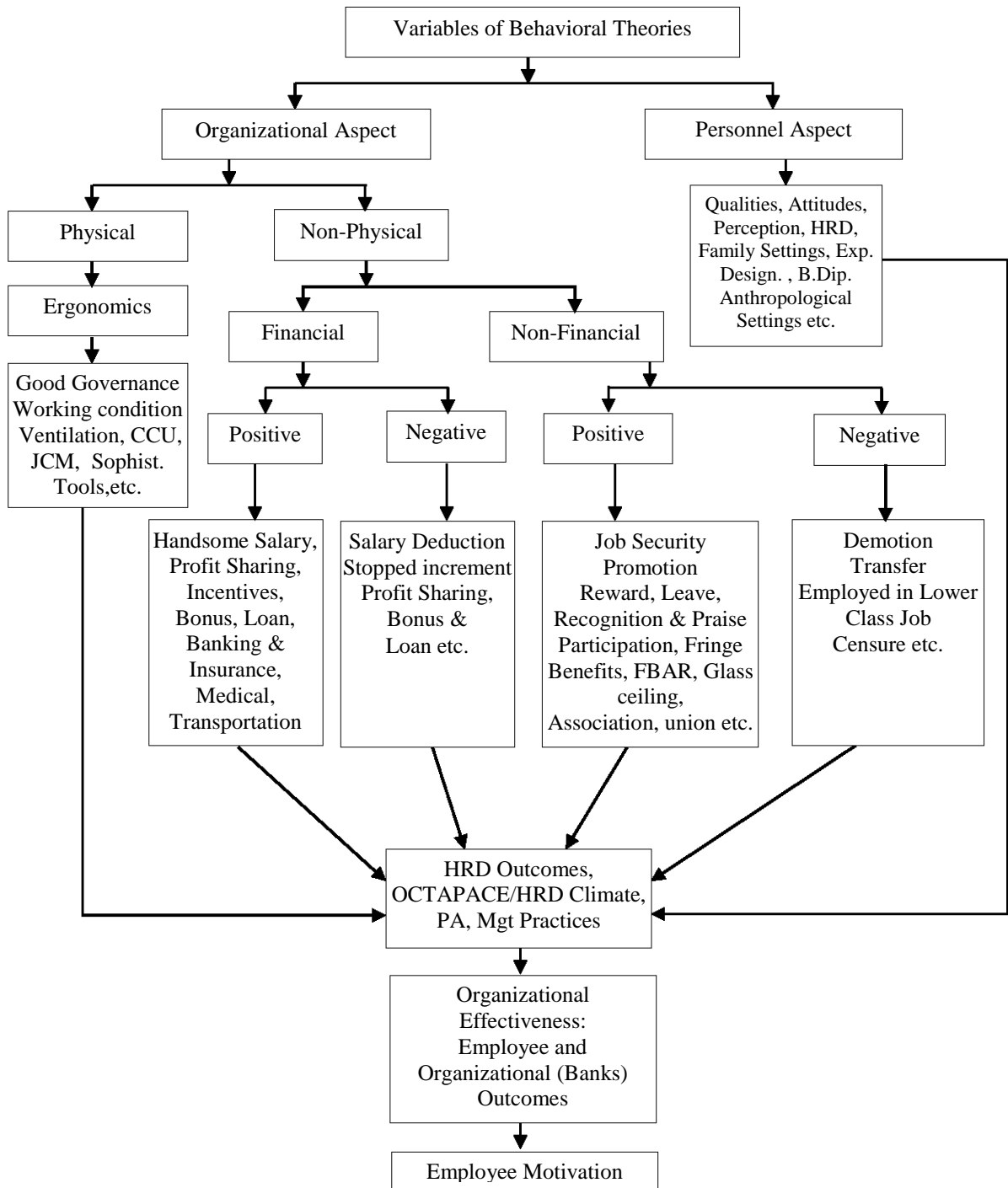

Figure 3.1: Conceptual framework

3.9 Flow Chart of Independent and Dependent Variables for Fitting Multiple Regression Model

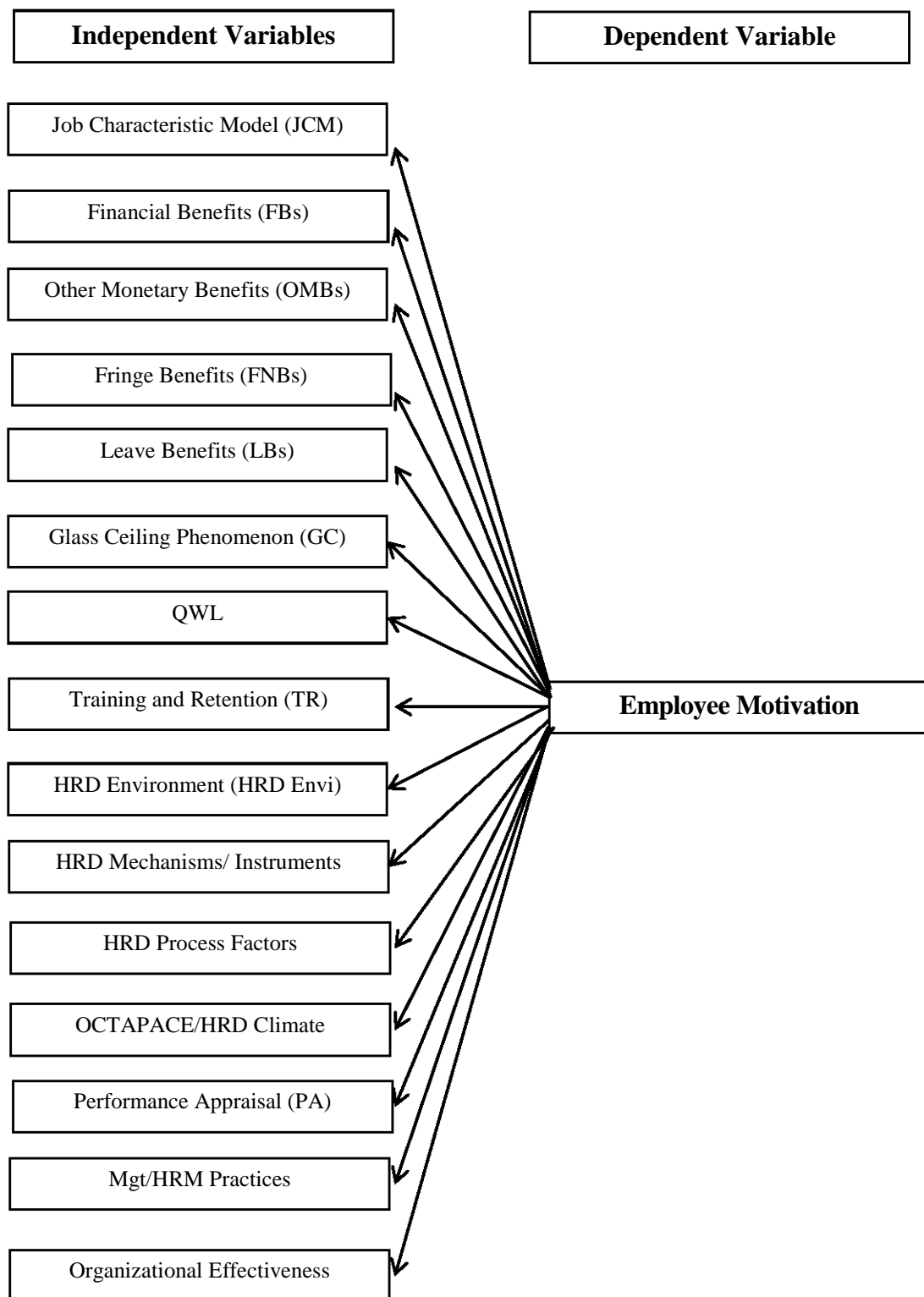

Figure 3.2: Flow chart of key factors of motivation

3.10 Hypotheses Construction

To test the following hypotheses some tests are applied in the analysis such the null and alternative based on the said objectives and reviewed literature of the study:

- H₀₁*: JCM factors have no significant effect on employee motivation in human resource development (HRD).
- H₀₂*: Financial benefits have no significant impact on the employee motivation in HRD.
- H₀₃*: Other monetary benefits have no significant outcome on the employee motivation in HRD.
- H₀₄*: Fringe-benefits have no significant effect on the employee motivation in HRD.
- H₀₅*: Leave benefits have no significant effect on the employee motivation in HRD.
- H₀₆*: Glass ceiling phenomenon does not have significant impact on the employee motivation in HRD.
- H₀₇*: Factors of QWL have no significant impact on the employee motivation in HRD.
- H₀₈*: Training and retention have no significant impact on the employee motivation in HRD.
- H₀₉*: HRD environment factors have no significant impact on the employee motivation in HRD.
- H₀₁₀*: HRD mechanism factors have no significant outcome on the employee motivation in HRD.
- H₀₁₁*: HRD process factors have no significant outcome on the employee motivation in HRD.
- H₀₁₂*: OCTAPACE have no significant effect on the employee motivation in HRD.
- H₀₁₃*: Performance appraisal (PA) factors have no significant impact on the employee motivation in HRD.
- H₀₁₄*: Management practices factor have no significant effect on the employee motivation in HRD of the banking sector.
- H₀₁₅*: Factors of organizational effectiveness (employee and organizational outcomes) have no significant effect on the employee motivation in HRD.

Chapter Four

Demographic and Glass Ceiling Composition with Motivation Issues

In this chapter, section 4.1 (Demographic Outlines) and section 4.2 (Glass Ceiling and Composition) present the specific research objective two that mean examining the demographic and glass ceiling composition with the employee motivation issues.

4.1 Demographic Outlines

This section of the chapter includes the different issues of demographic composition such as age, gender, experience, salaries, incentives, designation, initial and gross pay, etc. influencing employee motivation in the banks. Motivation means inspiring people to work continuation. Motivated employees have the best quality of performance. Employees' motivation is influenced by various factors. The total environment of the banking industry has become changed due to face competitive sustainability. Basic pay, gross pay, designation, promotion, scoring of banking diploma for considering upper-level post, experiences, location or posting, types of bank, etc. are the issues of demographic factors. Post and gross pay are highly correlated for motivation. Different emerging theories of stimulus influence age, experience, salary, rank, etc. Work experience is related to holding position through gradation of any organization. Maslow's essential classification theory proves problems with population data.¹ On the other hand, the supportive part of the Two-Factor Model, namely Hygiene and Motivating factors. Employees can enjoy these factors related to opportunities over the long-term service of the organization.²

4.1.1 Research Questions on Demographic Outlines

Do demographic factors effect employee motivation in the banking sector?

4.1.2 Chapter Objective

The main objective of this chapter (Section 4.1) is to explore underlying effective factors of demographic and motivating emphases among the employees in the banking sector of Bangladesh.

¹ Abraham H. Maslow, *Motivation and Personality* (NY: Harper, 1954).

² Federick Herzberg, "Workers' needs: the same around the world", *Industry Week*, 1987: 29-30 32.

In this chapter (Section 4.1), the study has explored the most effective factors in case of demographic as well as motivation issues. Inferential statistics, namely regression model, ANOVA, coefficients etc. have been used to examine the present demographic factors that are related to employee motivation in the banking sector of Bangladesh.

Table 4.1: Demographic outlines of the respondents

Demographic profile of the respondents					
		Freq.	Percent	Public Bank	Private Bank
Gender	Male	334	83.5	263	71
	Female	66	16.5	57	9
	Total	400	100.0	320	80
Age group	<30 years	16	4.0	11	5
	31-40 years	222	55.5	172	50
	41-50 years	55	13.8	35	20
	>50 years	107	26.8	102	5
Marital status	Married	396	99.0	318	78
	Unmarried	4	1.0	2	2
Religion	Islam	357	89.3	286	71
	Hindu	42	10.5	34	8
	Others	1	0.3	0	1
Type of bank	Public	320	80.0	320	80
	Private	80	20.0		
Name of the Bank	Sonali Bank Limited (SBL)	95	23.8	95	0
	Janata Bank Limited (JBL)	77	19.3	77	0
	Agrani Bank Limited (ABL)	66	16.5	66	0
	Rajshahi Krishi Unnayan Bank (RAKUB)	82	20.5	82	0
	Pubali Bank Limited (PBL)	15	3.8	0	15
	Uttara Bank Limited (UBL)	14	3.5	0	14
	National Bank Limited (NBL)	13	3.3	0	13
	Dutch-Bangla Bank Limited (DBBL)	13	3.3	0	13
	Prime Bank Limited (PrBL)	12	3.0	0	12
BRAC Bank Limited	13	3.3	0	13	
Location of the Banks (District)	Rangpur	166	41.5	136	30
	Dinajpur	171	42.8	139	32
	Nilphamari	63	15.8	45	14
Location of the Bank (Upazila)	Rangpur Sadar	117	29.3		
	Mithapukur	15	3.8		
	Pirgasa	11	2.8		
	Kaunia	8	2.0		
	Taragonj	3	.8		
	Badargonj	12	3.0		
	DinajpurSadar	87	21.8		
	Birampur	18	4.5		
	Fulbari	18	4.5		
Parbatipur	16	4.0			

Demographic and Glass Ceiling Composition with Motivation Issues

	Chirirbandar	20	5.0		
	Birgonj	12	3.0		
	Kaharul	4	1.0		
	NilphamariSadar	21	5.3		
	Saidpur	30	7.5		
	Jaldhaka	8	2.0		
Educational Qualification	Bachelor (pass/honors)	68	17	66	2
	Master	332	83	254	78
Major Subject/ Group	Science	127	31.8	102	25
	Humanities	200	50	177	23
	Business	73	18.3	41	32
Banking Diploma	Nil	249	62.3	176	73
	Part-1	85	21.3	83	2
	Part-2	66	16.5	61	5
Work Experience (Year)	1-5	45	11.3	33	12
	6-10	182	45.5	147	35
	11-15	32	8.0	11	21
	16-20	16	4.0	12	4
	20+	125	31.3	117	8
Present Designation/ Post	Supervisor	3	0.8	3	0
	Officer	95	23.8	76	19
	Senior Officer (SO)	119	29.8	106	13
	PO/ EO	92	23.0	68	24
	SPO/ SEO/AVP/FAVP	65	16.3	45	20
	AGM/ SAVP	19	4.8	16	3
	DGM	5	1.3	4	1
	GM	2	0.5	2	0
Present Basic Salary (Tk.)	<10000	2	0.5	4	2
	10000-20000	44	11.0	31	13
	21000-30000	150	37.5	126	18
	30000+	204	51.0	159	47
Present Gross Salary (Tk.)	<20000	4	1.0	2	1
	20000-40000	72	18.0	63	9
	40000-60000	152	38.0	129	23
	60000+	172	43.0	126	47
First Joining Designation	AC/CC/AA/CLDA/UDA/Data Entry Operator	94	23.5	91	3
	Supervisor/ Cashier	14	3.5	14	0
	Computer Operator	1	0.3	1	0
	JO/AO/TA/LFA	43	10.8	3	40
	Officer (C)/ Officer/TO	145	36.3	127	18
	SO (C)/ SO	101	25.3	84	17
	AVP	2	0.5	0	2
Initial Basic Salary (Tk.)	<10000	279	69.8	234	46
	10000-20000	107	26.8	77	30
	21000-30000	10	2.5	8	2
	30000+	4	1.0	1	2
Initial Gross Salary (Tk.)	<20000	345	86.3	300	46
	20000-40000	50	12.5	19	31
	40000-60000	1	0.3	0	1
	60000+	4	1.0	1	2

Flow Chart of Demographic and Motivation Issues

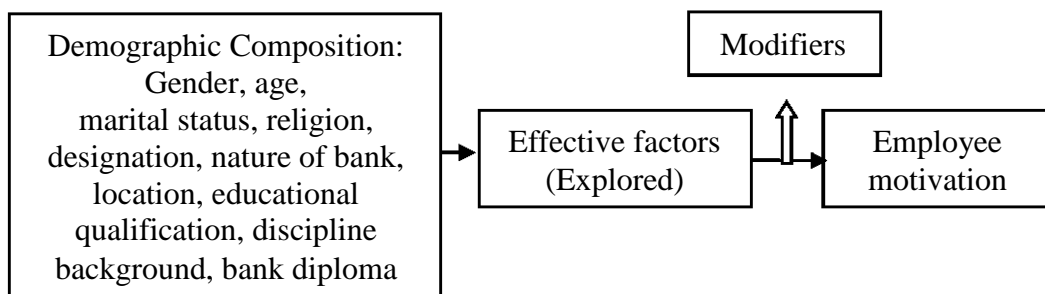

Figure 4.1: Demographic composition and motivational issues

4.1.3 Association of Demographic Outlines and Employee Motivation

- H_{01} No association exists between employee motivation and work experience.
- H_{02} There is no association between motivation and present basic pay
- H_{03} Present grosspay has no impact on employee motivation.
- H_{04} Initial basic pay has no effect on motivation in the sampled banks.
- H_{05} Initial gross pay has no effect on motivation of the bank employee.

4.1.4 Results and Discussion

Regression model is applied here for work experience (Table 4.2, 4.5, 4.8, 4.11, 4.14).

Table 4.2: Regression-model summary^b of work experience

Model	R	R Square	Adjusted R Square	Std. Err. of Estimates	Change Statistics				
					R ² Change	F	df1	df2	Sig. F
1	0.971 ^a	0.942	0.940	2.741	0.94	483.94	13	386	0.000

a. Predictors: (Constant), Banking Diploma, Group/ Subject, Gender, Religion, Educational Qualification, Marital Status, Location (District), Type of Bank, Present Designation, First joining designation/post, Name of the Bank, Age, Location (Upazilla). b. Dependent Variable: Working experience (year).

The linear regression model fitted for job experience and other independent variables listed. The model fits well for the dataset, and the multiple determining coefficients (R^2) is 0.942 (Table 4.2). Due to R^2 is 0.94, the dependent variable i.e., *working experience* 94% explained by the independent predictors.

Table 4.3: ANOVA^a of working experience

Model		Sum of Squares	df	Mean Square	F	Sig.
1	Regression	47261.760	13	3635.520	483.944	0.000 ^b
	Residual	2899.737	386	7.512		
	Total	50161.498	399			

a. Dependent Variable: Working experience (year)

b. Predictors: (Constant), Banking Diploma, Group/ Subject, Gender, Religion, Educational Qualification, Marital Status, Location (District), Type of Bank, Present Designation, First joining designation/post, Name of the Bank, Age, Location (Upazilla).

Hypothesis: The null hypothesis, $H_0: \beta_0 = \beta_1 = \beta_2 = \dots = \beta_{13} = 0$

The alternative hypothesis, $H_1: \beta_0 = \beta_1 = \beta_2 = \dots = \beta_{13} \neq 0$

Table 4.3 (ANOVA), the fitted regression model F-test statistic value is 483.944, and the significance value (*p*-value) 0.000 which is less than 0.05 (*p*-value< α). Then all the regression coefficients are statistically highly significant at 5% level of significance. That is, the null hypothesis is rejected or an alternative hypothesis is accepted. Therefore, all the regression coefficients were not zero (0).

Table 4.4: Coefficients^a of work experience

Unstandardized Coefficients		Standardized Coefficients	t	Sig.
β_i	Std. Error	Beta		
(Constant: Experience)		-16.110 (β_0)	2.519	
Gender		0.664 (β_1)	0.402	0.022
Age		0.800 (β_2)	0.034	0.663
Marital status		0.697 (β_3)	1.417	0.006
Religion		-0.535 (β_4)	0.439	-0.015
Present designation		1.294 (β_5)	0.181	0.152
First joining post		-1.663 (β_6)	0.147	-0.286
Type of Bank		-0.567 (β_7)	0.636	-0.020
Name of the Bank		-0.192 (β_8)	0.113	-0.039
Location (District)		0.341 (β_9)	0.665	0.020
Location (Upazilla)		-0.055 (β_{10})	0.098	-0.023
Educational qualif.		-0.860 (β_{11})	0.257	-0.057
Group/ Subject		0.001 (β_{12})	0.206	0.000
Banking Diploma		0.013 (β_{13})	0.223	0.001

The fitted regression model can be defined as,

Working experience

$$\begin{aligned}
 &= -16.110 * (\text{Constant}) + 0.664 * \text{Gender} + 0.800 * \text{Age} + 0.697 \\
 &* \text{Marital Status} - 0.535 * \text{Religion} + 1.294 * \text{Present designation} \\
 &- 1.663 * \text{First joining designation} - 0.567 * \text{Type of Bank} - 0.192 \\
 &* \text{Name of the Bank} + 0.341 * \text{Location (Disrtict)} - 0.055 \\
 &* \text{Location (Upazilla)} - 0.860 * \text{Educational qualification} + 0.001 \\
 &* \text{Group or Subject} + 0.013 * \text{Banking Diploma}
 \end{aligned}$$

The fitted regression model explains that the *age*, *present designation*, *first joining designation*, *educational qualifications* are statistically significant at 5% level of significance (Table 4.4). Consequently, employees' motivation is overstated by the control variable, namely age, designation, and educational qualification. The subject or major discipline does not directly influence motivation (β_{12}) =0.001 and *p*-value is 0.996. Among the significant independent predictor's *age* (0.800, and *present designation* (1.294) have the impact to the dependent variable *working experience*.

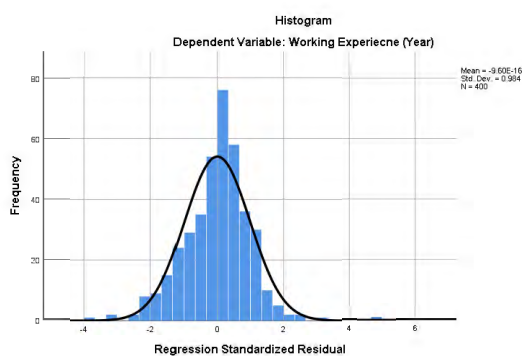

Figure 4.2: Histogram and P-P plot of work experience

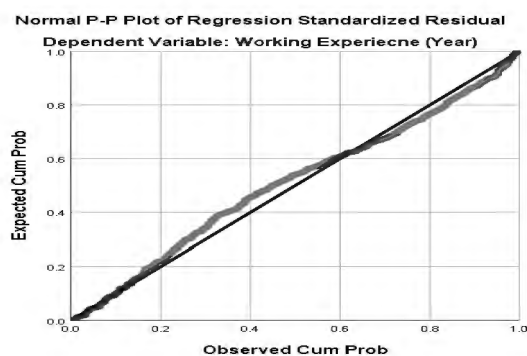

Figure 4.3: Histogram and P-P plot of work experience

Figures 4.2 & 4.3 illustrate that the fitted histogram confirming the bell-shaped curve and Q-Q (quantile-quantile) plot the fitted residual line transient through the source of origin. Thus, the dependent variable *job experience (year)* is usually distributed, and the linear regression model fits best for the dataset.

Table 4.5: Regression-model summary^b of present basic pay

Model	R	R ²	Adjusted R ²	Std. Err. of the Estimates	Change Statistics				
					R ²	F change	df1	df2	Sig. F
1	0.877 ^a	0.769	0.762	6987.86	0.769	99.1	13	386	0.000
a. Predictors: (Constant), Banking Diploma, Group/ Subject, Gender, Religion, Educational Qualification, Marital Status, Location (District), Type of Bank, Present Designation, First joining designation/post, Name of the Bank, Age, Location (Upazilla).									
a. Dependent Variable: Present Basic Pay.									

The above fitted linear regression model (Table 4.5) for *present basic payment* and other independent variables listed. The model fits best for this dataset, and the coefficient of multiple determinations R² is 0.769. Since the R² ~ 0.77 then the dependent variable i.e., 77% of *present basic pay* explained by the independent variables/predictors stated above.

Table 4.6: ANOVA^a of present basic pay

ANOVA ^a						
Model		Sum of Squares	df	Mean Square	F	Sig.
1	Regression	62872948092.258	13	4836380622.481	99.045	0.000 ^b
	Residual	18848472031.68	386	48830238.424		
	Total	81721420123.94	399			
a. Dependent Variable: Present Basic Salary						
b. Predictors: (Constant), Banking Diploma, Group/ Subject, Gender, Religion, Educational Qualification, Marital Status, Location (District), Type of Bank, Present Designation, First joining designation/post, Name of the Bank, Age, Location (Upazilla).						

ANOVA Table, the fitted regression model F-test statistic value is 99.045 and the significance value (*p*-value) 0.000 (showed in Table 4.6). Then all the regression coefficients are statistically strongly significant at 5% level of significance. Thus, the alternative hypothesis is accepted. Therefore, all the regression coefficients are not zero (0).

Table 4.7: Coefficients^a of present basic pay

Model	Unstandardized Coefficients		t	Sig.
	β_i	Std. Error		
(Cons: Present basic pay)	-38670.051 (β_0)	6422.814	-6.021	0.000
Gender	554.461 (β_1)	1024.262	0.541	0.589
Age	709.891 (β_2)	86.209	8.235	0.000
Marital Status	-5124.611 (β_3)	3613.823	-1.418	0.157
Religion	1360.314 (β_4)	1118.681	1.216	0.225
Present designation	6201.641 (β_5)	461.322	13.443	0.000
First joining post	1902.867 (β_6)	374.125	5.086	0.000
Type of Bank	1834.212 (β_7)	1621.950	1.131	0.259
Name of the Bank	282.551 (β_8)	289.017	0.978	0.329
Location (District)	-1672.287 (β_9)	1695.606	-0.986	0.325
Location (Upazilla)	74.986 (β_{10})	250.856	0.299	0.765
Educational qualifi.	1623.504 (β_{11})	656.077	2.475	0.014
Group/ Subject	-323.377 (β_{12})	525.967	-0.615	0.539
Banking Diploma	878.569 (β_{13})	569.666	1.542	0.124

Table 4.7 showed the *age*, *present designation*, *first joins designation*, *educational qualifications* are being statistically highly significant at 5% level of significance. Among the significant independent predictor's *age* (**709.891**), *present designation* (**6201.641**) and first joining post (**1902.867**) do have a positive contribution to the dependent variable *present basic payment*.

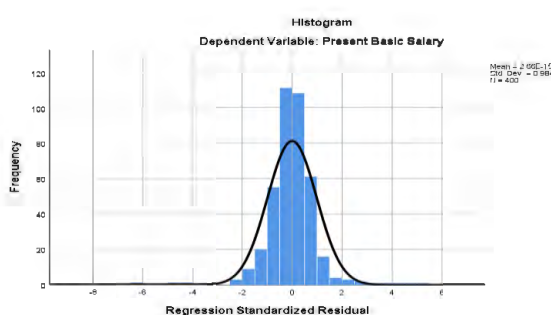

Figure 4.4: Histogram and P-P plot of present basic pay

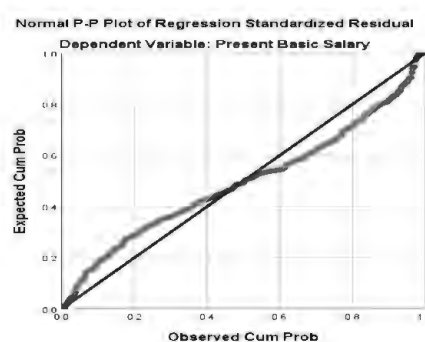

Figure 4.5: Histogram and P-P plot of present basic pay

From the fitted histogram (Figure 4.4 & 4.5) illustrate the bell-shaped curve and Q-Q plot the fitted residual line transient through the origin. Therefore, the dependent variable *current basic pay* is usually dispersed and the linear regression model well fits for this dataset.

Table 4.8: Regression-model summary^b of present gross pay

Regression-Model Summary ^b									
Model	R	R ²	Adjusted R ²	Std. Err. of the Estimates	Change Statistics				
					R ²	F change	df1	df2	Sig. F
1	0.826 ^a	0.682	0.672	15365.25	0.682	63.742	13	386	0.000
a. Predictors: (Constant), Banking Diploma, Group/ Subject, Gender, Religion, Educational Qualification, Marital Status, Location (District), Type of Bank, Present Designation, First joining designation/post, Name of the Bank, Age, Location (Upazilla)									
b. Dependent Variable: Present gross salary									

The fitted linear regression model (Table 4.8) for *present gross salary* and other independent variables enumerated. The model is a good fit for this dataset, and the coefficient of multiple determinations R^2 is 0.682. Since the $R^2 \sim 0.682$, then the dependent variable i.e., present gross salary 68.2% explained by the independent predictors.

Table 4.9: ANOVA^a of present gross pay

ANOVA ^a						
Model		Sum of Squares	df	Mean Square	F	Sig.
1	Regression	195635872639.298	13	15048913279.950	63.742	0.000 ^b
	Residual	91131097360.703	386	236090925.805		
	Total	286766970000.000	399			
a. Dependent Variable: Present gross salary						
b. Predictors: (Constant), Banking Diploma, Group/ Subject, Gender, Religion, Educational Qualification, Marital Status, Location (District), Nature of Bank, Present Designation, First joining designation/post, Name of the Bank, Age, Location (Upazilla)						

Table 4.9 (ANOVA) states that the fitted regression model F-test statistical value is 63.742, and the significance p -value is 0.000. Then all the regression coefficients are statistically highly significant at 5% level of significance. That is, H_a is accepted. Therefore, all the regression coefficients are not zero (0).

Table 4.10: Coefficients^a of present gross pay

Model	Unstandardized Coefficients		t	Sig.
	B	Std. Error		
(Constant: Present gross)	-76402.124	14122.791	-5.410	0.000
Gender (β_1)	1172.807	2252.196	0.521	0.603
Age (β_2)	1244.412	189.561	6.565	0.000
Marital Status (β_3)	-9286.091	7946.247	-1.169	0.243
Religion (β_4)	1028.259	2459.809	0.418	0.676
Present designation (β_5)	10226.033	1014.378	10.081	0.000
First joining design. (β_6)	3129.422	822.645	3.804	0.000
Type of Bank (β_7)	15523.420	3566.423	4.353	0.000
Name of the Bank (β_8)	420.502	635.505	0.662	0.509
Location (District) (β_9)	-4565.112	3728.379	-1.224	0.222
Location (Upazilla) (β_{10})	326.900	551.594	0.593	0.554
Educational qualification (β_{11})	2791.159	1442.615	1.935	0.054
Group/ Subject (β_{12})	-282.423	1156.521	-0.244	0.807
Banking Diploma (β_{13})	1700.733	1252.610	1.358	0.175

It is being observed (Table 4.10) that the *age*, *present designation*, *first joins designation*, *educational qualification* are statistically significant at 5% level of significance. Among the significant independent predictor's *age* (**1244.412**), *present designation* (**10226.033**), *first joining position* (**3129.422**) and *type of the bank* (**15523.420**) do have the impact on dependent variable *present gross salary*. Thus, there is a strong association among age, present position, joining post, and nature of the bank influencing employee satisfaction.

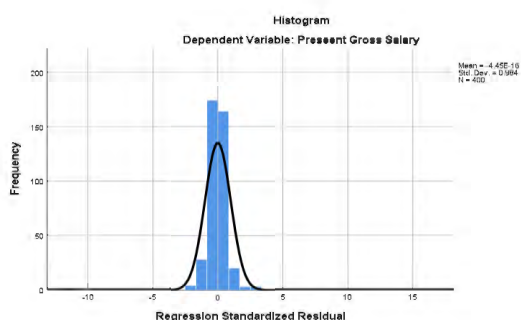

Figure 4.6: Histogram and P-P plot of present gross pay

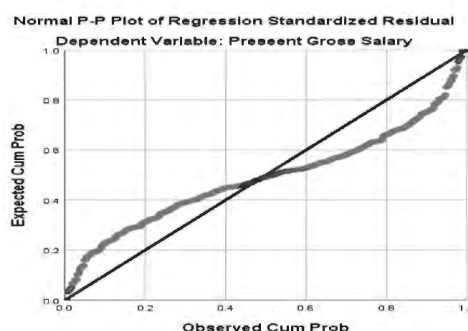

Figure 4.7: Histogram and P-P plot of present gross pay

Figures 4.6 & 4.7, the fitted histogram depicts the bell-shaped curve and Q-Q plot the fitted residual line fleeing through the source. Therefore, the dependent variable *present gross pay* is generally disseminated, and the linear regression model best fits for this dataset.

Table 4.11: Regression model summary^b of initial basic pay

Model	R	R ²	Adjusted R ²	Std. Err. of the Estimates	Change Statistics				
					R ²	F Change	df1	df2	Sig. F
1	0.689 ^a	0.475	0.457	5713.00316	0.475	26.857	13	386	0.000

a. Predictors: (Constant), Banking Diploma, Group/ Subject, Gender, Religion, Educational Qualification, Marital Status, Location (District), Type of Bank, Present Designation, First joining designation/post, Name of the Bank, Age, Location (Upazilla). b. DV: Initial basic pay

The fitted linear regression model (Table 4.11) for *initial basic pay* and other independent variables listed. The model is a good fit for this dataset, and the coefficient of multiple determinations R² is 0.475. Since the R² ~ 0.475, then the dependent variable that means, *initial basic pay* 47.5% explained by the independent estimators.

Table 4.12: ANOVA^a of initial basic pay

ANOVA ^a						
Model		Sum of Squares	df	Mean Square	F	Sig.
1	Regression	11395615319.173	13	876585793.783	26.857	0.000 ^b
	Residual	12598424380.577	386	32638405.131		
	Total	23994039699.750	399			
a. Dependent Variable: Initial basic salary b. Predictors: (Constant), Banking Diploma, Group/ Subject, Gender, Religion, Educational Qualification, Marital Status, Location (District), Type of Bank, Present Designation, First joining designation/post, Name of the Bank, Age, Location (Upazilla).						

ANOVA **Table 4.12**, the fitted regression model F-test statistical value is 26.857 and significance value is 0.000 (p -value) then all the regression coefficients were statistically significant at 5% level of significance. That means, the null hypothesis is rejected or, the alternative hypothesis is accepted. Thus, all the regression coefficients were not zero (0).

Table 4.13: Coefficients^a of initial basic pay

Model	Unstandardized Coefficients		t	Sig.
	B_j	Std. Error		
(Constant: Initial Basic Pay)	6234.435	5244.365	1.189	0.235
Gender (β_1)	-350.697	838.100	-0.418	0.676
Age (β_2)	-121.912	71.022	-1.717	0.087
Marital Status (β_3)	1247.972	2977.753	0.419	0.675
Religion (β_4)	-21.884	918.839	-0.024	0.981
Present Designation (β_5)	-671.561	378.451	-1.775	0.077
First joining designation (β_6)	2220.853	308.118	7.208	0.000
Type of Bank (β_7)	-1285.682	1402.737	-0.917	0.360
Name of the Bank (β_8)	1064.391	236.772	4.495	0.000
Location (District) (β_9)	1761.002	1401.011	1.257	0.210
Location (Upazilla) (β_{10})	-280.441	206.022	-1.361	0.174
Educational Qualification (β_{11})	-879.276	538.907	-1.632	0.104
Group/ Subject (β_{12})	-306.230	431.933	-0.709	0.479
Banking Diploma (β_{13})	-199.290	462.560	-0.431	0.667

Table 4.13 of the regression coefficients shows that the *first joining post* and *name of the bank* have become statistically significant at the 5% significance level. Significant independent (individual) predictors had a positive contribution in case of the position (first joining level) (**2220.853**), and name of bank (**1064.391**) dependent variable which means *initial basic pay*.

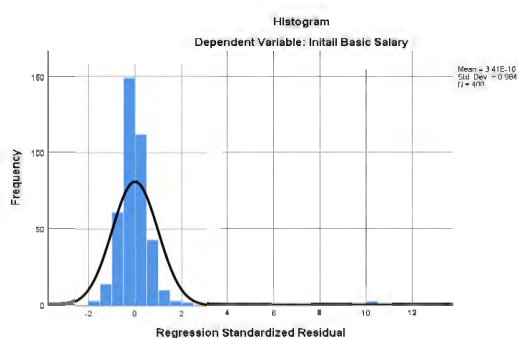

Figure 4.8: Histogram and P-P plot of initial basic pay

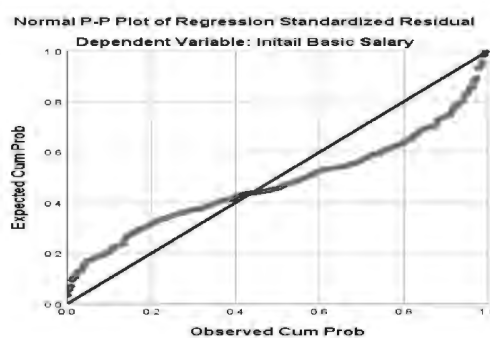

Figure 4.9: Histogram and P-P plot of initial basic pay

Figures 4.8 & 4.9 illustrate that the fitted histogram shows a bell-shaped curve and the Q-Q plot shows the line of fitted residue as it passes through the source. Thus, the dependent variable i.e., *initial basic pay* is generally distributed and the linear regression model fits well for this dataset.

Table 4.14: Regression-model summary^b of initial gross pay

Model	R	R ²	Adjusted R ²	Std. Err. of the Estimates	Change Statistics				
					R ²	F Change	df1	df2	Sig. F
1	0.592 ^a	0.351	0.329	13459.34450	0.351	16.058	13	386	0.000

a. Predictors: (Constant), Banking Diploma, Group/ Subject, Gender, Religion, Educational Qualification, Marital Status, Location (District), Type of Bank, Present Designation, First joining designation/post, Name of the Bank, Age, Location (Upazilla). DV: Initial gross pay

Table 4.14 shows the statistical value of the fitted regression model F-test at 16.058, and the significant value at 0.000 (*p*-value). All the resistance coefficients are then statistically significant at the 5% significance level. That is, the null assumption is rejected. Thus, all the regression coefficients are not zero (0).

Table 4.15: Coefficients^a of initial gross pay

Model	Unstandardized Coefficients		t	Sig.
	B	Std. Error		
(Constant: Initial Gross Pay)	181.712	12371.000	0.015	0.988
Gender (β_1)	25.992	1972.834	0.013	0.989
Age (β_2)	-90.130	166.047	-0.543	0.588
Marital Status (β_3)	5525.183	6960.595	0.794	0.428
Religion (β_4)	-251.863	2154.695	-0.117	0.907
Present designation (β_5)	-1829.536	888.554	-2.059	0.040
First joining designation (β_6)	4425.217	720.604	6.141	0.000
Type of Bank (β_7)	-1458.181	3124.043	-0.467	0.641
Name of the Bank (β_8)	2449.083	556.677	4.399	0.000
Location (District) (β_9)	2369.895	3265.911	0.726	0.468
Location (Upazilla) (β_{10})	-360.575	483.174	-0.746	0.456
Educational qualification (β_{11})	-1895.923	1263.673	-1.500	0.134
Group/ Subject (β_{12})	164.586	1013.066	0.162	0.871
Banking Diploma (β_{13})	321.652	1097.236	0.293	0.770

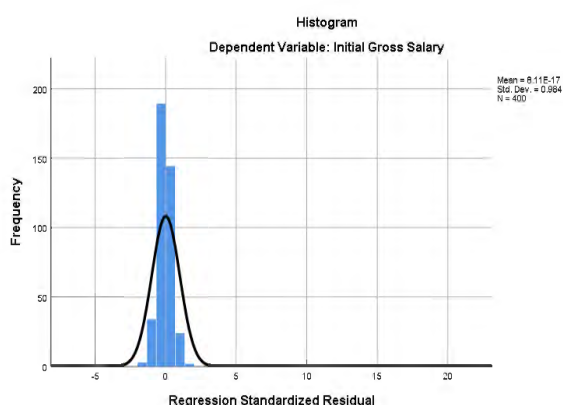

Figure 4.10: Histogram and P-P plot of initial gross pay

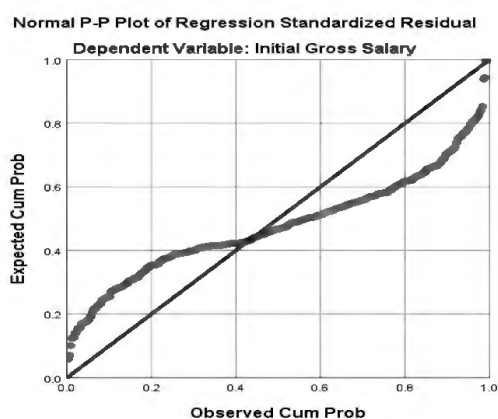

Figure 4.11: Histogram and P-P plot of initial gross pay

The fitted histogram shows the bell-shape curve and the Q-Q plot is the transient plot of the remaining line planted through the source (Figure 4.10 & 4.11). Thus, the dependent variable which is the *initial gross pay* is usually scattered and the linear regression model fits best for this dataset.

Table 4.16: Effect of demographic factors on motivation

H_0	Demographic factors and impact on employee motivation
H_{01}	Employee motivation is associated to work experience.
H_{02}	The relationship between motivation and current basic pay.
H_{03}	Present gross pay influences employee motivation.
H_{04}	Initial gross pay stimulates employee positively.
H_{05}	Initial basic pay motivates employee in the bank.

It can be clarified that employees in the deal of the banking sector influenced by the age, experience, present designation, joining post, nature of bank, present, and initial gross (Table 4.3, 4.6, 4.9, & 4.12). There have strong relationships among these source variables. Masculinity (gender) does not influence the satisfaction existing employees in banks. Midst these factors the most effective factors are explored namely age and present designation (*coefficient value 0.663 and 0.571*). Instead, banking diploma mostly influences the promotion in case of the public bank.

4.1.5 Findings on Demographic Factors and Employee Motivation

Table 4.17: Effective factors of demographic issues and employee

Demogra. Factors	R ²	Coefficient value	Effective factors	Motivation
Work experience	94%	Age ($\beta=0.663$), present designation ($\beta = 0.152$)	Age	Therefore, motivation is highly associated and modified by demographic effective factors already explored in column 4.
Present basic pay	77%	Present designation ($\beta=0.571$), age ($\beta=0.461$), and first joining post ($\beta=0.256$)	Present designation/post	
Present gross pay	68.2%	Present designation ($\beta=0.503$), age ($\beta=0.432$), type of bank ($\beta=0.232$), and first joining post ($\beta=0.225$)		
Initial basic pay	47.5%	First joining post ($\beta=0.551$), and nature of the bank ($\beta=0.326$)	First joining designation/post	
Initial gross pay	35.1%	First joining designation ($\beta=0.519$), and name of the bank ($\beta=0.337$)		

It is evident from the Table 4.17 work experience is 94% explained by independent variable, whereas age is strongly associated with job experience. Present basic pay 77% is explained by total forecasters, and it is highly affected by present designation of the existing employees. Present gross pay 68.2% is varied by the estimators and it is mostly influenced by the present status of an employee. The initial basic payment is 47.5% ~48% explained by variance, and is prejudiced by first joining post/status. On the other hand, initial gross pay 35.1% is explained by total variance and it is strongly influenced by employees' first joining designation (Table 4.2, 4.4, 4.5, 4.7, 4.8, 4.10, 4.11, 4.13, 4.14, 4.15, & 4.16). Therefore, employee motivation of the banking sector of Bangladesh is highly associated with working experience, current and initial pay packages which are mostly modified by demographic issues namely age, present, and starting designation. Thus, the equation is employee motivation = $f(0.663*Age + 0.571*Present\ designation + 0.503*Initial\ designation)$.

4.2 Glass Ceiling Phenomenon in the Banking Sector

The aim of the section 4.1 is to investigate the factors of glass ceiling, for which female employees have been influenced in the workplace. This section covers the study objective 2: To examine glass ceiling phenomenon and motivational issues in the banking sector.

‘Glass ceiling’ means an invisible obstacle to the advancement of women in the organizational structure. The burning issue of ‘glass ceilings’ has created to describe the subtle obstacles that hindered the advancement of women or minorities in the 1980s or decades.³ The study showed that the same work has performed by senior managers and partners, but post-senior managers received about 40 to 50 percent less compensation for their work than equity partners.⁴ These post-senior positions include post-senior manager positions and “driving gender inequality” between partners. It maintains gender inequality between senior manager positions and partners after creating opportunities for success in the profession.

4.2.1 Background of the Glass Ceiling Phenomenon

Banking sector is putting a significant contribution to the financial and social life of Bangladesh. This sector employs a large number of workers and provides training in human resource development. Women employees are leading a significant portion of the human resources employed in the banking sector in the country. The present study will be looked at how public and private banks are evaluating women executives in human resources. The bank and its staffing policy support equal employment opportunities (EEO) across the country. Women employees have been holding the several levels of positions in the structure of banking corporations since they started financial transactions.

The term ‘glass ceiling’ has two dimensions in the public sector- (i) the nature of barriers that limit women’s progress and (ii) women’s own perceptions in the workplace. The role of women worldwide is undergoing a dramatic change. Gender equality is a concept that women and men enjoy equal opportunities and results. Women and men have equal dignity; enjoy the same human rights; play an equally valuable role in their national, economic, social and cultural development and enjoy the benefits of the equality.^{5&6} At the present time there is a common impediment to women around the

³ Merida L. Johns, “Breaking the Glass Ceiling: Structural, Cultural, and Organizational Barriers Preventing Women from Achieving Senior and Executive Positions”, *Online Research Journal in Health Information Management*, 2013, PMID: 23346029.

⁴ Elizabeth Dreike Almer, Margaret G.Lightbody, & Louise E. Single, “Successful Promotion or Segregation from Partnership? An Examination of the “Post-Senior Manager” Position in Public Accounting and the Implications for Women’s Careers from http://apira2010.econ.usyd.edu.au/conference_proceedings/APIRA-2010-277-LightbodyPost-senior-manager-positions-and-womens-careers-in-public-accounting.pdf.

⁵ Gender Policy 3rd Edition, RDRS *Bangladesh*, September 2014: 8-11.

world in the services of banks, telecom industry, airline professionals, doctors, journalism etc. Bangladesh is no exception. The IWPR measured and showed the wage gap in the United States income inequality between men and women. Causes of inappropriate part of women to spend time for family and child care instead of father.⁷ Another observation of this report has shown that the way female employees have been treated by the bank in various posts. An empirical study conducted on the women's position in the banking sector of Bangladesh.⁸ The study has revealed that the women employees are negligible at top level showing the position whereas 85% of men and 15% of female and 25% at entry level position. For this, the researchers attempted to find out the reasonable factors behind the invisible barrier (glass ceiling) for the motivation and satisfaction of women in the banking sector.

4.2.2 Present Context of Glass Ceiling Phenomenon and Its Composition

This section has highlighted the women employees' their status, position in the different organizations nationally and globally.

Table 4.18: Global gender gap, world economic forums (WEFs, 2020, BD: 2018, 2015, 2006)

Country	Global Index		Economic Participation		Educational Attainment		Health & Survival		Political Empower	
	Rank	Score	Rank	Score	Rank	Score	Rank	Score	Rank	Score
Bangladesh (BD)	50	0.726	141	0.438	120	0.951	119	0.969	7	0.545
India	112	0.688	149	0.354	112	0.962	150	0.944	18	0.411
Pakistan	151	0.546	150	0.327	143	0.823	149	0.946	93	0.159
Sri Lanka	102	0.680	126	0.558	88	0.988	1	0.980	73	0.193
Nepal	101	0.680	101	0.623	133	0.895	131	0.966	59	0.227
Bhutan	131	0.635	130	0.544	116	0.954	144	0.960	132	0.082
Maldives	123	0.646	131	0.518	1	1.00	147	0.953	115	0.111
BD, WEFs, 2018	48	0.725	133	0.441	116	0.980	117	0.969	5	0.26
BD, WEFs, 2015	64	0.704	130	0.462	109	0.948	95	0.971	8	0.433
BD, WEFs, 2006	91	0.627	107	0.423	95	0.868	113	0.950	17	0.267

According to WEFs Report in 2020 (Table 4.18) Bangladesh has been topped country in the ranked among its South Asian nationals by performing the best in taking alone gender gap. Bangladesh secured 72.6% of its overall gender gap and attained 50th position out of 153 countries globally, shown strong performance of the political

⁶ The Constitution, "There Shall be Equality of Opportunity for All Citizens in Respect of Employment or Office in the Service of the Republic", *The Constitution of the People's Republic of Bangladesh*, Act No. of 1972: Article 29 (1).

⁷ IWPR, "The Gender Wage Gap by Occupation", *Institute for Women's Policy Research*, 2019

⁸ Mohammad Azizur Rahman, and Mohammad Rafiul Azam Khan, "Investigating the Effect of Women's Position in the Banking Sector of Bangladesh", *International Journal of Social Sciences and Management*, Nepal, Vol. 7 (4): 191-197. DOI: 10.3126/ijssm.v7i4.32483.

empowerment (scored of 54.5%, 7th) over the 50 years of its independence. In the financial sphere, as of 2018, 38% of adult women were part of the labor force (up from 34% in 2017), comparing with 84% of men.

Table 4.19: Global gender gap, world economic forums (WEFs, 2020)

Country	Labor Force Participation (%)		Legislators, Sr. officials and managers		Professional and technical workers (%)	
	Female	Male	Female	Male	Female	Male
Bangladesh (BD)	38.1%	69.9%	11.4%	88.6%	29.7%	70.4%
India	24.8%	81.6%	13.7%	86.3%	30.3%	69.7%
Pakistan	25.2%	84.5%	4.9%	95.1%	23.3%	76.7%
Sri Lanka	38.2%	77.1%	28.4%	71.6%	49.0%	51.0%
Nepal	84.7%	86.3%	18.4%	86.6%	37.5%	62.5%
Bhutan	60.7%	76.8%	18.5%	81.5%	32.8%	67.2%
Maldives	43.7%	84.6%	19.6%	80.4%	49.3%	50.7%
Norway	75.2%	79.2%	35.6%	64.4%	52.6%	47.4%
Canada	75.1%	81.9%	35.5%	64.5%	57.6%	42.4%
USA	66.8%	77.7%	40.7%	59.9%	52.9%	47.1%

Table 4.19 shows that in Bangladesh female 38.1% of labor force participation, 11.4% of sr. Officials and managerial position and ~30% of professional and technical workers according to WEFs Report 2020. In South Asian region Sri Lanka, and Maldives women positions are remarkable. Norway, Canada and USA secured the significant rank of women's participation.

Table 4.20: Overall leadership effectiveness by gender position (percentile scores) and in EU

Position	Male	Female
Top Management, Executive, Senior Team Members, Reports to Top Management, Supervises Middle Managers	57.7%	67.7%
Managers	48.9%	56.2%
Senior Front Line Manager, Foreman	52.5%	52.6%
Individual Contributors	52.7%	53.9%
Others	50.7%	52.0%
Total	51.3%	55.1%
Women Managerial Position in EU (in percentage)	Male	Female
Managers	63%	37%
Board Members	72%	28%
Senior Executives	82%	18%

Source: Zenger Folkman Inc., 2011

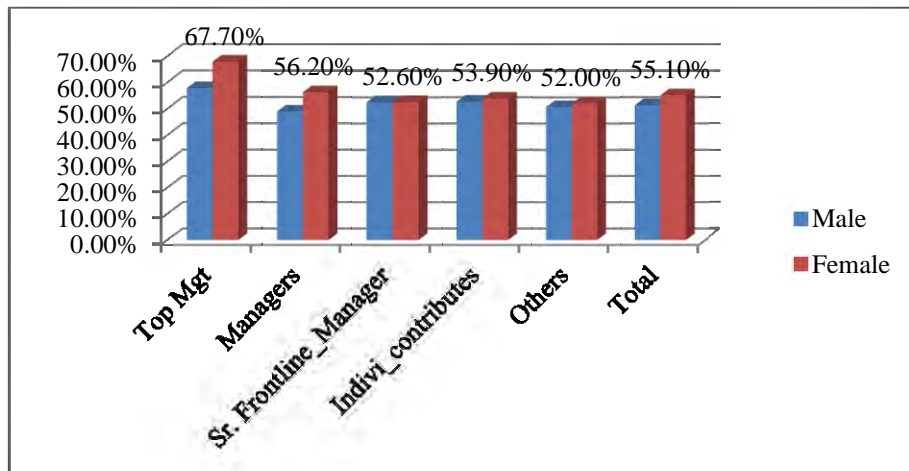

Figure 4.12: Overall leadership effectiveness by gender position

Table 4.20 and Figure 4.12 explains that overall leadership effectiveness by gender position whereas female 67.7% (percentile) at the top and completely 55.1%. On the other hand, it is evident that women in EU 7% of managerial position.

Table 4.21: Top five countries with highest and lowest % of women in managerial positions

Highest Women Managerial Position			Lowest Women Managerial Position		
Rank	Country	Percentage (%)	Rank	Country	Percentage (%)
1	Jamaica	59.3%	1	Pakistan	3.0%
2	Colombia	53.1%	2	Algerai	4.9%
3	Saint Lucia	52.3%	3	Jordan	5.1%
4	Philippines	47.6%	4	Bangladesh *	5.4%
5	Panama	47.4%	5	Qatar	6.8%

Source: ILO, 2015(www.weforum.org, 2015)

Besides, found the managerial position found in the USA 42.7%, New Zealand 40%, UK 34.2%, Canada and Australia 36.2%. Bangladeshis women* are now become managers in business than the earlier which was 5.4% were chief executives of the largest companies in the world (www.weforum.org, 2015). It is observed in the Dominican Republic country (Caribbean) with the 55.8% (highest) of female employees contributing the senior and mid-level managerial roles. On the other, Jamaica ranked at the top with 59.3% (highest) of women managers followed by Colombia with 53.1% and Yemen ranked late one with 2% of women managers according to ILO (2015).⁹

⁹ Report, *World Employment and Social Outlook: The Changing Nature of Jobs- Trends 2015*, ILO, Geneva.

Table 4.22: Employed population by broad economic sector (2016-2017)¹⁰ and Statistics of Civil Officers and Staff in the ministries and directorates by category 2010 (in percentage)

Employed and Broad Economic Sector			Civil Officers and Staff (%)		
Category	Women	Men	Category	Women	Men
Agriculture	60%	32%	Class-1	5%	7%
Industry	17%	22%	Class-2	2%	3%
Service	23%	46%	Class-3	72%	70%
Total	100.0	100.0	Class-4	21%	20%
			Total	100.0	100.0

Source: Women and Men in Bangladesh: Facts and Figures 2018; BBS, 2019: SIDA, p.59

Table 4.23: Female and male employed in the banking sector of Bangladesh and women's position in the hierarchy of management (BB Report 2019: Gender Equity Status)

Category	Female	Male	Women's position		
Six State-owned Banks	7,262 (16.42%)	42,788 (83.58%)	Top	Mid	Low
Three Specialised Banks	1495 (0.88%)	10,670 (99.12%)	8.4%	15.30%	15.48%
Forty Private Banks	16,076 (18.33%)	87,711 (81.67%)	Banks' Board Level Women's Position was 13.34%		
Foreign Banks	938 (31.96%)	2,935 (68.04%)			
Overall employed	25,771(17.88%)	1,44,104 (82.12%)	Less than the year 2019		
Previous year 2018	24,991 (17.45%)	1,43,201 (82.55%)	→ Slightly increased		
Growth (2018-2019)	780 (0.43%)	903(0.43%)			
Non-Bank Institutions	16%	86%			

Source: BB: (January-June, 2019), published 27 September 2019; compiled by researcher

Table 4.23 shows overall 17.88% of women employees serving the banking sector of Bangladesh. Female in the private banks was of 18.33% and foreign banks 31.96%. Below the average percentage of women's participation in specialized banks was 0.88%. On the other hand, it has observed that 16% of female employees in the non-banking financial institutions. BB figures showed that women existence at banks' top level jobs was 8.49% and ratio of women in the banks' board was 13.34%.

The proportion of women in the management position in the EU is 37% (Table 4.21). Jamaica holds the highest position 59.3% of women in the management structure of companies and the lowest management position is occupied by 5.4% of Bangladeshi's women.¹¹ According to the Global Gender Gap, Bangladesh ranks 11.4% of women at the senior level and 6.6% of men.¹² The total number of female employees in the banking sector of Bangladesh is 17.88%. Women accounted for 18.33% in private banks and 31.96% in foreign banks. The average percentage of women's participation in

¹⁰ Women and Men in Bangladesh: Facts and Figures 2018; BBS, 2019, SIDA: 59

¹¹ ILO, "Top Five Countries with Highest and Lowest of Women in Managerial Positions" www.weforum.org, 2015.

¹² Global Gender Gap, World Economic Forums (WEFs), 2020.

specialized banks was 0.88%. On the other hand, it has been observed that non-banking financial institutions have 16% female employees. BB statistics showed that the presence of women in top level jobs in banks was 8.49% and the proportion of women on the boards of banks was 13.34%. (BB Report 2019).¹³ The present study sought to explore the effective causes of glass ceiling in influencing the motivation of women in the banking sector in Bangladesh.

4.2.3 Research Questions and Data Analysis of the Glass Ceiling Phenomenon

This section (Section: 4.2) outlines the process of analyzing the primary data collected from survey with the application of inferential statistical tools for finding answers of research questions set for the study. Analysis has been organized in line with the sequence of research questions.

- a. What causes pay discrimination in Banks?
- b. Does gender affect glass ceiling in Banks?
- c. Does the nature of banks affect glass ceiling?

4.2.4 Developing Hypotheses on Glass Ceiling Composition

- H_{01} : There is no significant difference between gender and equal importance in the bank.
- H_{02} : There is no difference between the nature of bank and equal treatment of male and female employees in the bank.
- H_{03} : There is no significance difference between gender and pay discrimination in the banking sector.
- H_{04} : There is no significant relationship between designation and pay discrimination of the male and female employees in the bank.
- H_{05} : There is no difference between the type of bank and pay discrimination in the banking sector.
- H_{05} : There is no difference between present pay and discrimination of the both male and female employees in the banks.
- H_{06} : There is difference between gender (male and female) and glass ceiling in case of assigning vital post in the banking sector of Bangladesh.
- H_{07} : There is no difference of logistic support provided regarding glass ceiling phenomenon in the bank.
- H_{08} : There is no relationship of advancement in case of glass ceiling phenomenon in the banking sector.

¹³ BB Official, *The Asian Age*, 26 April 2017.

- H_{09} : There is no association of discrimination in recruitment and selection regarding glass ceiling phenomenon in the bank.
- H_{010} : There is no difference between gender and delegation of authority in the banking sector of Bangladesh.
- H_{011} : There is no difference assigning women in the vital post and glass ceiling phenomenon in the bank.
- H_{012} : There is no relationship difference between the nature of bank and glass ceiling phenomenon.

The main objective of the section 4.2 is to investigate the effective factors of glass ceiling phenomenon on employee motivation in the banking sector of Bangladesh.

- a. Identify the factors accountable for pay discrimination in Banks.
- b. To examine whether gender affects glass ceiling in Banks.
- c. To investigate how nature of banks affect glass ceiling.

In the above demographic profile (Table 4.1: Demographic Profile), regarding 400 employees in identified area where the percentage of male and female are 83.5% and 16.5% respectively. Most of the 222 employees (55.5%) are between the ages of 31-25. The proportionate between types of bank are 80% and 20% of the respondents being come from public banks and private banks respectively. Most participants (83.5%; 'yes' section) agreed with the statement of equal importance. Employees (75.8%, 'yes' section) made their statement that female employees have decreased performance due to additional family responsibilities. It has found that there is no pay inequality (98%, 'no' category). Work-related logistical support was evenly distributed (87.3% agreed). There has no bias in the staffing process (73.25% agreed). There have some barriers to the advancement of women in the organization structure (67.8% of the respondents agreed). It has found that there is gender inequality in the gender cage (63.3% agreed). It has also noted that bias has been created when scheduling an important post (55.3% agreed).

The following Table 4.24 summarizes the level of satisfaction among the existing staff in the bank. The survey has been found that there is a lower level of satisfaction with the appointment of women representatives (63.3%) as well as women (55.3%) in significant positions.

Table 4.24: Score matrix of high, moderate and low perception (> 50%) on female employee

Glass ceiling (Scale_freq.)	High	Moderate	Low	Remarks
Job related logistic support equally distributed	87.3%	11.3%	0.3%	Observed that female employees working in banks are highly satisfied with logistical support, growth and recruitment and selection policies.
Observing barrier to women advancement in the banking job	67.8%	25.5%	6.8%	
No discrimination in recruitment and selection	94%	6%	0%	
<i>Discrimination in the delegation of authority</i>	6.3%	30.5%	63.3%*	*&*** Low level of satisfaction and female staff face challenges in assigning delegates and key positions.
<i>Problem to assign women employee in a vital post</i>	11.5%	33.3%	55.3%**	

4.2.5 Developing Logistic Regression Model for the Perception of the Respondents

Logistic Regression (LR) is well fit for describing and testing assumptions/ hypothesis about the association between a categorical/dichotomous outcome variable (Yes, No) and one more continuous estimator factors for the classified results. This regression does not represent a linear relationship between two variables.¹⁴ In this model the Wald Statistic¹⁵ used to assess the statistical significance of the coefficient (β) value. If the *Beta* (β) coefficient value is positive and greater than $\text{Exp}(B)$, the outcome will be effective i.e., $\text{Exp}(B) > 1$. And if the value of β is negative, it represents less effective when $\text{Exp}(B) < 1$. The present study attempted to signify the information about perception of the banks' employees through using the dichotomous variables and Likert scale. Thus, the LR model applied in case of equal treatment and importance (EI), female performance (FP) and pay discrimination (PD) in the study (shown in the Table 4.25, 4.26, and 4.27).

4.2.6 Equal Importance (EI)

EI indicates equal treatment of employees in the workplace. The present study seeks to justify habits of equal importance to both male and female employees in banking industry.

¹⁴ Serkan Akinci, Erdener Kaynak, Eda Atilgan, and Şafak Aksoy, "Where Does the Logistic Regression Analysis Stand in the Marketing Literature? A Comparison of the Market Positioning of Prominent Marketing Journals", *Marketing Literature*: 2005, Vol. 539: 34. www.emeraldinsight.com/0309-0566.

¹⁵ Franklin Adu-Gyamfi, "Prediction of Loan Default Using Logistic Regression: A Case Study of Ahafo Ano Premier Rural Bank", *Master Thesis*, 2016, Kwame Nkrumah University of Science and Technology, Kumasi.

The Table 4.25 stated that the glass ceiling of equal importance and do have a strong relationship with each other (Wald $p < 0.05$) and satisfied according to hypothesis. Therefore, there has no impact on equal importance and gender (Ho1 been supported). In the equation, the nature of the bank represents highly effective (since β was positive and 5 times more important, $\text{Exp}(B) = 5.296$, Wald $p = 0.000$) in case of equal treatment of both male and female. There is an impact in equal importance and the nature of bank regarding glass ceiling since Ho2 was not sustained. In the equation, it has also realized that the women employee influenced by the type of bank (public and private). Therefore, the equation, $\hat{Y}(\text{EI, Estimated}) = -3.38(\text{constant}) - 0.13 + 1.67 - 0.09$

Table 4.25: Equal importance (EI) of male and female (Effective when $\text{Exp}(B) > 1$)

Variables	β	S.E.	Wald	df	Sig.	Exp(B)	Remarks
Gender	-0.13	0.404	0.096	1	0.757	0.882	Less effective and insignificant
Bank type	1.67	0.303	30.18	1	0.000	5.296	Significantly effective
Edu.qualicn	-0.09	0.206	0.199	1	0.655	0.912	Less effective and insignificant
EI Const.	-3.38	0.803	17.74	1	0.000	0.034	Less effective but significant

NB: Variable(s) independent: Gender, type of bank, educational qualification (Edu. qua).
 Dependent: Equal importance (EI constant). LB & UB stand for lower boundary and upper boundary

4.2.7 Pay Discrimination

Pay discrimination indicates the situations where employees are paid not in an equal rate rather a discriminated ways in terms of gender or others.

The Table 4.27 supported the hypotheses model. It has observed that gender and marital status are effective with the pay discrimination but not statistically significant (respectively β 17.113 and β 10.971; Wald $p > 0.05$). There is no difference between male and female in case of glass ceiling in the banking sector (Ho3 accepted). The designation of the employees is the most effective factor in case of pay discrimination (β 1.191, $\text{Exp}(B) = 3.290 > 1$ and Wald p -value $0.037 < 0.05$). This is cause to accept the alternative hypothesis and Ho4 is rejected. There has effectiveness between present designation and pay discrimination in the bank. The nature or type of bank is less effective with the pay but statistically significant ($\beta = -3.356$, and $p = 0.001 < 0.05$, Ho5 not supported, $\text{Exp}(B) < 1$). Thus there is a significant relationship between the nature of bank and pay discrimination. On the other hand, it has been observed and the significance difference between present pay and pay discrimination regarding gender issue in the bank (since Ho6 been rejected). Educational background is ineffective in case of pay. Experience as well as present basic pay is not effective with the pay

discrimination. The equation may be \hat{Y} (PD, Estimated) = -9.397 (constant) + 17.113-0.091+ 10.971-3.052+1.91-5.356+18.3-8.101-2.177-0.02

Table 4.26: Model summary of pay discrimination

Step	-2 Log likelihood	Cox & Snell R Square	Nagelkerke R Square	Remarks
1	35.683 ^a	0.101	0.569	~57% variance explained
a. Estimation terminated at iteration number 20 because maximum iterations has been reached. Final solution cannot be found				

Table 4.27: Pay discrimination (PD) ‘yes’ category (effective when Exp(B)>1)

Pay discrimination (PD) ‘yes’ category (Effective when Exp(B)>1)								
		B	S.E.	Wald	df	Sig.	Exp(B)	Remarks
Step 1 ^a	Gender	17.113	3874.88	0.000	1	0.996	2705+	Highly effective but insignificant
	Age	(-0.091)	0.092	0.989	1	0.320	0.900	Less effective and insignificant
	Marital	10.971	11740.0	0.000	1	0.999	58182	Less effective and insignificant
	Religion	(-3.052)	1.565	3.805	1	0.051	0.047	Significant but less effective
	Desig	1.191	0.570	4.365	1	0.037	3.290	Significantly effective
	NBank	(-5.356)	1.601	11.19	1	0.001	0.005	Significantly effective
	Location	18.300	1607.06	0.000	1	0.991	8862+	Effective but insignificant
	Edu.Qua.	(-8.101)	1748.18	0.000	1	0.996	0.000	Not effective
	BDip	(-2.177)	0.882	6.097	1	0.014	0.113	Significantly less effective
	Experi	-0.02	0.055	0.150	1	0.699	0.979	Insignificant and less effective
	PBP	0.000	0.000	5.29	1	0.021	1.000	Significantly not effective
	Cons (PD)	(-9.397)	13525.2	0.000	1	0.999	0.000	Insignificantly not effective
a. Variable(s) entered on step 1: Var01=Gender, Var02=Age, Var03= Marital Status, Var04=Religion, Var05.1= Designation (Desig), Var06= Nature of Bank (NBank), Var08.1= Location (Loca), Var09.1= Educational Qualification (Edu. Quali), Var09.3=Banking Diploma (BDip), Var10=Experience (Experi) and Var11.1=Present Basic Pay (PBP)								
b. Constant: Pay Discrimination (PD).								

It is noted in Table 4.28 that the overall value of all factors is not negligible due to $p>0.05$; that is, not all alternative estimates has been sustained. It is found that there is a significant relationship between glass ceiling and assigning female in the vital post practices in the banking sector ($p= 0.048 < 0.05$; H_0 null hypothesis rejected). The overall mean value was 3.721 about extent level. It can be noted that there is no significant relationship of glass ceiling and male and female (overall_GC, $p= 0.463 > \alpha$). Thus, there is an effect of glass ceiling phenomenon in case of male and female in the sampled banks.

4.2.8 Glass Ceiling Perspective to Male and Female Issue

Hypotheses: There is no difference between male and female employees on receiving logistic supports, advancement, recruitment and selection, DoA and assigning in the vital post in Banks.

Table 4.28: Glass ceiling phenomenon of male and female in the bank

Factors	Male		Female		Levene's t-Test for Equality of Means			NB: MD = Mean Difference; SD = Standard Deviation; 95% Conf. Interval of the Difference; Sig. (2-tailed).
	Mean	SD	Mean	SD	MD	t	Sig.	
Logistic supp.	3.898	0.357	3.879	0.329	0.019	0.408	0.683	
Advancement	3.599	0.616	3.667	0.591	-0.068	-0.824	0.411	
No discri_R&S	4.145	0.510	4.136	0.426	0.013	0.199	0.842	
Disc_DoA	3.557	0.626	3.636	0.516	-0.079	-1.102	0.273	
Assig_vital post	3.407	0.695	3.600	0.656	-0.184	-1.981	0.048	
Overall_GC	3.721	0.561	3.784	0.504	-0.060	-0.66	0.451	

NB: The Levene's test indicates the significant difference of F Statistics so the top line (equal variance assumed) is appropriate for the explanation ($p > .05$). It reveals from the line that null hypothesis is true ($p > .05$) thus accepted (Annexure I: Output Table 1-4). If $p < .05$ then the bottom line (equal variance not assumed) is appropriate for explanation and thus the alternative hypothesis is accepted (Annexure I: Output Table 5).

4.2.9 Glass Ceiling Perspective of Gender and Types of Bank

Hypothesis: There is no difference between male and female employees on receiving logistic supports, advancement, recruitment and selection, DoA and assigning in the vital post in regarding the nature of banks.

Table 4.29 noted that the p -values of all the elements are highly significant since $p < 0.05$; that is, all null hypotheses have been rejected (from H_{09} to H_{013}). Therefore, there has highly association of especially advancement/promotion, recruitment and selection, delegation of authority, assigning women in the important post regarding glass ceiling phenomenon in the public and private bank. H_{08} is accepted. The overall average (mean) value of a public bank was higher than that of a private bank. It is found that there has disparity between the representatives of delegating authority in the case of female employees (mean value of male and female was 3.653 and 3.238 respectively). Employees of private bank opined that there is a problem in assigning women in a vital post. The remaining other factors are observed positively concerned in the glass ceiling phenomenon in the private bank of Bangladesh. There has highly significant effect of glass ceiling in case of logistic support, advancement, recruitment and selection, delegation of authority, assigning women in the vital post of the bank ($p < 0.05$).

Table 4.29: Glass ceiling phenomenon in the public and private banks

Factors	Public Bank		Private Bank		Levene's Test for Equality of Means			Remarks on mean
	Mean	SD	Mean	SD	MD	F	Sig.	
Logistic support	3.913	0.343	3.825	0.382	0.088	1.993	0.064	Existing significant relationships among the factors of glass ceiling in the bank.
Advancement	3.672	0.556	3.363	0.750	0.309	4.129	0.001	
No discrimi_R&S	4.234	0.467	3.800	0.461	0.434	7.466	0.000	
Discrimi_DoA	3.653	0.544	3.238	0.733	0.416	5.668	0.000	
Assign_vital post	3.575	0.614	2.888	0.712	0.688	7.936	0.000	
Overall_GC	3.810	0.505	3.423	0.608	0.387	5.438	0.010	

NB: MD = Mean Difference; SD = Standard Deviation; 95% Conf. Interval of the Difference; Sig. at 5% level of significance (2-tailed). The Levene's test indicates the significant difference of F Statistics so the top line (equal variance assumed; (Annexure II: Output Table Section 1) is appropriate for the explanation ($p > .05$). It reveals from the line that null hypothesis is true ($p > .05$) thus accepted. If $p < .05$ then the bottom line (equal variance not assumed) is appropriate for explanation and thus the alternative hypothesis is accepted (Annexure II: Output Table Section 2 to 5).

Table 4.30: Overall results of null hypotheses (H_0)

NH	p -value	Remarks	Impact/ relationship of glass ceiling factors
H_{01}	$p = 0.757$ (Table 3)	Accepted	No relationship exists between the gender and equal treatment in the bank.
H_{02}	$p = 0.000$ (Table 3)	Rejected	There is a highly relationship of the nature of bank and equal treatment.
H_{03}	$p = 0.997$ (Table 4)	Accepted	No significance difference between gender and pay discrimination in the bank was observed.
H_{04}	$p = 0.042$ (Table 4)	Rejected	There has a statistically significant difference between designation and pay discrimination regarding glass ceiling in banks.
H_{05}	$p = 0.013$ (Table 4)	Rejected	Glass ceiling does have an impact on the nature and type of bank regarding pay discrimination.
H_{06}	$p = 0.021$ (Table 4)	Rejected	There is a significant relationship of male and female employee regarding pay discrimination in the banking organization.
H_{07}	$p = 0.048$ (Table 5)	Rejected	There is a significant difference between gender (male and female) and glass ceiling phenomenon in case of assigning vital post in the banking sector.
H_{08}	$p = 0.064$ (Table 6)	Accepted	There has a highly relationship of advancement, recruitment and selection, delegating authority, <i>assigning vital post</i> , and nature of bank regarding glass ceiling phenomenon in the banking sector observed (H_{09} - H_{013}). Null hypothesis is supported (H_{08}). Thus there is no difference of logistic support in terms of glass ceiling phenomenon in the bank.
H_{09}	$p = 0.000$ (Table 6)	Rejected	
H_{010}	$p = 0.001$ (Table 6)	Rejected	
H_{011}	$p = 0.000$ (Table 6)	Rejected	
H_{012}	$p = 0.000$ (Table 6)	Rejected	
H_{013}	$p = 0.010$ (Table 6)	Rejected	

4.2.10 Impact of Glass Ceiling on the Motivation in the Banks

Developing regression model in case of glass ceiling

H_0 : There is no significant effect of glass ceiling on employee motivation

Regression Coefficients ^a						
Model	Unstandardized Coefficients		Standardized Coefficients	t	Sig.	Remarks
	(β)	Std. Error	Beta			
(Constant)	0.713	0.259		2.758	0.006	H0 is rejected
Glass ceiling	0.750	0.063	0.510	11.817	0.000	
a. Dependent Variable: Employee Motivation;						
b. Predictors: (Constant), Glass ceiling						
c. $R^2 = 0.51$						
d. Durbin-Watson Value 1.673 (within $0 < 2.0$)						

Therefore, there is a significant (p -value is $0.000 < 0.05$; H_0 is rejected) impact of glass ceiling on the employee motivation in the banking sector.

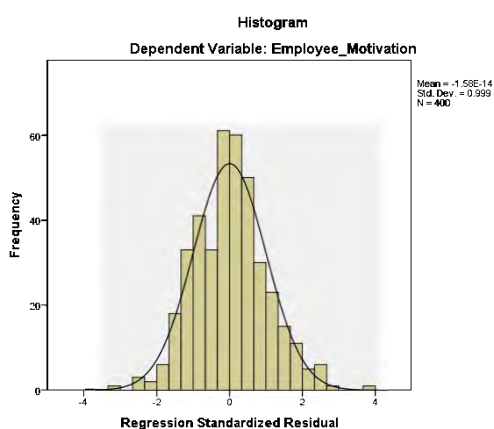

Figure 4.13: Histogram of glass ceiling and motivation

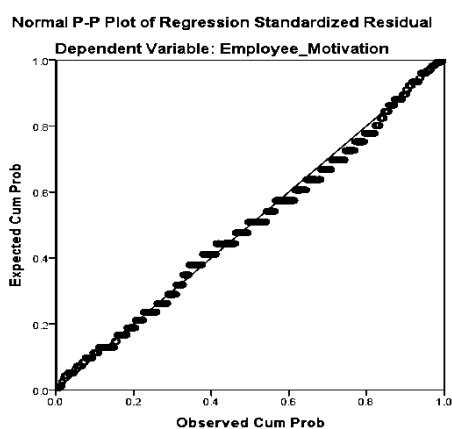

Figure 4.14: P-P plot of glass ceiling and motivation

4.3 Discussion on Findings

Motivation is complex to determine its level. This study (section 4.1) found from the empirical analysis based on demographic outlined that the most effective factors age, present designation, first joining designation have been explored and strongly associated with employee motivation in the banking sector of Bangladesh. On the other hand, The study (section 4.2) found that there has no difference in the types of bank, salary or equal treatment of both men and women. Women are divided when it comes to appointing them to important positions, delegating authority, moving to the top at workplace. Finally, the researcher found a strong effective factor in influencing the

women while assigning in a vital post as the cause of the demotivation of female employees in banks.

The researcher found that the overall glass ceiling of public banks is higher than that of private banks. It should be concluded that identifying the availability of sampled banks can re-evaluate the three factors by determining particularly important assignments, inequality in DoA and prospects for advancement for female employees thereby increasing employee satisfaction and motivation. This is why; female employees are relegated to the banking organization. For overcoming the challenges regarding glass ceiling women currently know better and how they fight for that. In recent times, women represent 49.6% of the world's working people. If so, a 26% contribution to income will be added to GDP by 2025. It is expected that women's participation in the job market have increased since the rate rose to 4% in 1974, but it has been found to be 35.6% in 2016.¹⁶ Now women are able to move forward with strong enrichment and confidence, eliminating mental stigma and stereotyped mentality adapting with male staff. It is expecting that women have broken down in their careers concerned in “Glass ceilings” by developing their distinctive characters and overcoming household burdens. Women still refer to career advancements as balanced work and personal life as a common struggle.¹⁷

¹⁶ [www. https://idlc.com/](https://idlc.com/)

¹⁷ Nancy K. Weidenfeller, “Breaking through the Glass Wall: The Experience of Being a Woman Enterprise Leader”, *Human Resource Development International*, 2012, Vol. 15(3):365.

Chapter Five

Employee Satisfaction and Motivation

Introduction

Management is an art of getting things done through deploying human resources in the organization. Motivation activates or energizes people and assists them to sustain dynamic role in the workplace. With a view to reaching the predetermined goal of organization, motivation is highly essential. It increases morale and productivity of the existing employees. For creating favorable outlook among employees about the banking industry, motivation and its role in management functions very effective tools. Banking sector of Bangladesh can concentrate, remove and hindrances standing way of changes so that motivation supplements the interest, enthused and diligent employees. This chapter contains the level of satisfaction, maintenance and motivational factors, and job characteristics (JCM). The chapter study has attempted to determine the different factors of satisfaction through the perception of that influence the behavior of existing employees.

This chapter is divided into three main sections included satisfaction, job characteristics model, and hygiene and motivating Factors. Descriptive and inferential statistics have been used to analyze the data. Moreover, the chapter has constructed the individual and latent variable to explore the effective factors influencing employee satisfaction and motivation. Finally the multiple regression has also been developed in case of showing the relationship between the dependent (satisfaction) and independent (job characteristics, hygiene and motivational) variables. The aim of the chapter is to determine the factors of motivation through satisfaction among the bank employees (representing the study objective number 3).

Before going to the main focus of this chapter five, the followings are to be conceived:

5.1 Relationship between Motivation and Satisfaction

Motivation as well as work-satisfaction measurement elements are not one. Since job satisfaction is mainly evaluated by the work environment and the facilities provided by

the banks and by the surrounding conditions. Motivation creates an extra work satisfaction effort. In fact, motivation and job satisfaction are intimately linked.

Motivation and job satisfaction are closely related to each other. Motivation is very much important to acquire job satisfaction. That's why, many people take these two terms as synonymous. Motivation is the key factor of action and refers to the drive and effort to satisfy a want or goal. It is the recreation of an employee's sentiment to his/her job. When an employee can concentrate himself/herself on his/ her own business in a fair condition it is referred to as motivation. Satisfaction refers to the pleasure experienced when a want is fulfilled. In a short, motivation involves a drive toward and outcome, and satisfaction is the outcome already achieved. Motivation denotes to encourage the employee by satisfying them their financial and some other amenities. It makes or compels the employees to be (intently) keenly attentively as well as self-sacrificing. This is how, motivation - job satisfaction, both of these work as well instigation for each other in a positive way.

The measuring elements of inspiration (motivation) as well as job-satisfaction are not same. Because, the job satisfaction is evaluated largely by the working environment and the facilities (amenities) given by the organization and itself surrounding circumstances. Motivation creates an additional job satisfaction attempt. In fact, motivation as well as job satisfaction is related inseparably to each other.

5.2 Pay and Motivation

It is true that money plays an important role in motivating employees. But this is not an obvious fact. Herzberg and his associates (1959)¹ proved that money is an incentive indicator which occupies sixth position in human needs. The higher order needs such as need for recognition, appraisal, power, status/ego/esteem etc., cannot be met by financial incentives only. These needs can be fulfilled by ensuring non-financial incentives or satisfying those needs. Job security, due time promotion, performance appraisal, rewards, job characteristics and other factors like skill variety, task identity,

¹ F. Herzberg "Motivational Theory", Retrieved on 16.10.10 from http://www.envisionsoftware.com/articles/Herzberg_Motivational_Theory.html.

task significance, autonomy, job feedback, participation, fringe benefits, leaves in different categories, retirement facilities etc. are referred as non-financial incentives.^{2&3}

In this case the sustainable motivation could be possible to adopt by the banking organization as well.

The main focal points of this chapter have been discussed in the following manners:

5.3 Employee Satisfaction

In this section researcher has examined the different factors influencing employee satisfaction and motivation.

5.3.1 Descriptive Statistical Analysis of Different Allowances in the Banks

Employee satisfaction influenced by different factors in the workplace. Banks are providing or entertaining salaries along with allowances for which the level of satisfaction influences. This section has observed following factors of satisfaction, and job characteristics that are the practiced by the banks.

Table 5.1: Travelling allowance (TA) with the salary

Perception	Freq.	%	Remarks
Yes	400	100.0	Surveys from the Table 5.1 shows that 100% of employees get TA.

Table 5.2: Lunch allowance (LA) with the salary

Perception	Freq.	%	Remarks
Yes	369	92.3	The researchers found (Table 5.2) that 92.3% of respondents received a luncheon allowance with a (maximum) salary.
No	31	7.8	
Total	400	100.0	

Table 5.3: Medical allowance with the salary

Perception	Freq.	%	Remarks
Yes	400	100.0	The cent percent of the participants got medical allowance (Table 5.3).
No	0	0	
Total	400	100.0	

² Neeru Malhotra, Pawan Budhwar, and Peter Prowse, "Linking Rewards to Commitment: An Empirical Investigation of four UK Call Centres", *In International Journal of Human Resource Management*, Routledge: Taylor & Francis Group, 2007: 2095-2127.

³ Nancy H. Shanks, "Management and Motivation", *In Introduction to Healthcare Management*, 3rd edition (United States: Jones & Bartlett Learning 2007): 2098.

Table 5.4: Child education allowance

Perception	Freq.	%	Remarks
Yes	150	37.5	Table 5.4 elucidates that 62.5% of the respondents received child education allowance.
No	250	62.5	
Total	400	100.0	

Table 5.5: Increment

Perception	Freq.	%	Remarks
Yes	400	100.0	Table 5.5 explains that 100% of the respondents got increment.

Table 5.6: Type/Time of increment

Perception	Freq.	%	Remarks
Yearly	355	88.8	It was observed (Table 5.6) that 88.8% of the respondents (public bank) entertained yearly increment and remaining employees of private bank limited got increment yearly but performance based.
Yearly based on performance	45	11.3	
Total	400	100.0	

Table 5.7: Number of yearly festival bonuses

Times	Freq.	%	Remarks
2.00	60	15.0	Table 5.7 shows that 80.75% of the participants received festival bonuses from the banks.
2.25	323	80.75	
3.00	17	4.3	
Total	400	100.0	

Table 5.8: Number of incentives received in the last year

Times of incentives	Frequency	Percent	Times of incentives	Frequency	Percent
0.00	85	21.3	3.00	178	44.5
1.00	17	4.3	3.25	71	17.8
1.50	1	0.3	3.25	1	0.3
2.00	24	6.0	4.00	1	0.3
2.25	1	0.3	5.00	20	5.0
2.50	1	0.3	Total	400	100.0

It is being observed (Table 5.8) that banking industry provide the incentives year-wise or performance based at the end of the fiscal years. It may vary as the policy of the respective bank either state-owned nationalized or public limited bank in Bangladesh. Employees are entertained the incentives based on the earning profits.

Table 5.9: Handsome salary structure

Perception	Freq.	%	Remarks
Yes	379	94.8	It was noticed that about 95% (Table 5.9) employees enjoyed their pay structure and were satisfied.
No	17	4.3	
Unknown	4	1.0	
Total	400	100.0	

Table 5.10: Working hours

Perception	Freq.	%	Remarks
Less than 8 hours	1	0.3	It was made clear by almost a percentage of the employees (Table 5.10) that they had to stay in serving for more than ten hours.
10 hours or more	399	99.8	
Total	400	100.0	

Table 5.11: Stress in the job

Perception	Freq.	%	Remarks
Yes	351	87.8	Table 5.11 explicates that about 88% of the respondents felt stress in their job.
Somewhat stressed	49	12.3	
Total	400	100.0	

Table 5.12: Impact of banking diploma on promotion

Perception	Freq.	%	Remarks
Yes	380	95.0	Table 5.12 made clear that 95% of the employees in the banking sector of Bangladesh disclose their opinion that the promotion depends on banking diploma especially in the state-owned bank.
No	20	5.0	
Total	400	100.0	

From the above (Table 5.1 to 5.12; direct answered by the respondents) it has been found that the banks are providing the allowances such as TA, DA, medical, child education, incentives, influencing existing employees' satisfaction. On the other hand, respondents reported that the working hours are higher than the normal working hours of other organizations. They are to face the stress in the job. Employees of the nationalized banks (public banks) opined highly about the impact of banking diploma for their upgradation.

5.3.2 Examining the Satisfaction Level

The study has measured the employees' perception regarding satisfaction (Table 5.15 to 5.20) on present pay, staffing, financial benefits, promotion, transfer and leave policies, as well as career development and prospect.

Table 5.13: Satisfaction level of present salary (PS)

Perception	Freq.	%	Remarks
Dissatisfied	1	0.3	The study (Table 5.13) observed that majority i.e., 71.3% of the employees felt satisfaction on their salary. On the other hand, approximately 27% of the employees moderately satisfied with their present salary they paid.
Moderately satisfied	106	26.5	
Satisfied	285	71.3	
Strongly satisfied	8	2.0	
Total	400	100.0	

Table 5.14: Satisfaction in recruitment and selection (R &S)

Perception	Freq.	%	Remarks
Moderately satisfied	20	5.0	It has been apparent (Table 5.14) that 88.5% of the respondents pleased with recruitment and selection methods and policy.
Satisfied	354	88.5	
Strongly satisfied	26	6.5	
Total	400	100.0	

Table 5.15: Satisfaction on financial benefits (FBs)

Perception	Freq.	%	Remarks
Dissatisfied	2	0.5	It is being observed (Table 5.15) that 69.8% of the employees satisfied with financial benefits as they enjoy. About 29% employees are judiciously satisfied regarding the financial benefits.
Moderately satisfied	115	28.8	
Satisfied	279	69.8	
Strongly satisfied	4	1.0	
Total	400	100.0	

Table 5.16: Satisfaction on promotion and transfer policy (P &T)

Perception	Freq.	%	Remarks
Strongly dissatisfied	1	0.3	From the Table 5.16 it is estimated that the majority of the employees of the sampled banks moderately satisfied and generally satisfied with the prevailing promotion and transfer policy.
Dissatisfied	57	14.3	
Moderately satisfied	176	44.0	
Satisfied	161	40.3	
Strongly satisfied	5	1.3	
Total	400	100.0	

Table 5.17: Satisfaction on leave policy (LP)

Perception	Freq.	%	Remarks
Dissatisfied	2	0.5	The survey (Table 5.17) found that 54.3% and 44% of the participants moderately and generally satisfied with the existing holiday policy existence in the banking industry of Bangladesh.
Moderately satisfied	217	54.3	
Satisfied	176	44.0	
Strongly satisfied	5	1.3	
Total	400	100.0	

Table 5.18: Motivation on career and development paths

Perception	Freq.	%	Remarks
Dissatisfied	5	1.3	It has been observed (Table 5.18) that majority i.e., 55.8% generally and 39.5% moderately satisfied of the employees on career and development paths they enjoyed in banks.
Moderately satisfied	158	39.5	
Satisfied	223	55.8	
Strongly satisfied	14	3.5	
Total	400	100.0	

5.3.3 Overall Satisfaction Score on Employee Perception

Table 5.19: Score of high, moderate and low job satisfaction level (>200, or 0.50%)

Factors	High	Moderate	Low	Remarks on scenario
PS	293 (73.3)	106 (26.5%)	1 (0.3)	Employees are being satisfied in case of pay, R&S and FBs.
R & S	380 (95%)	20 (5%)	0 (0%)	
FBs	281(70.8%)	115 (28.8%)	2 (0.5%)	
P&T	166(41.3%)	176* (44%)	58 (14.6%)	*** Moderately satisfied with promotion and leave policy.
LP	181 (45.3%)	217 (54.3%)*	2 (0.5%)	
CD	237 (59.3%)	158 (39.5%)	5 (1.3%)	Higher level satisfaction with CD.

It has been observed from the above analysis that the existing employees of the bank confirmed positively the satisfaction about the current pay, recruitment and selection, financial facilities. Employees are moderately satisfied about promotion and transfer, and leave policies (Table 5.13- 5.19).

5.3.4 Bivariate Analysis on Satisfaction Level of Banks' Employee

Table 5.20: Bivariate analysis of satisfaction by crosstabs

Perception on Satisfaction	Type of Bank		Chi ² -test and Fisher's Exact <i>p</i> -value
	Public	Private	
Satisfaction on present salary/pay (PS)			
Dissatisfied	0 (0%)	1 (1.25%)	Observed that $p=0.045$, alternative hypothesis (H_a) has been adopted. An association exists.
Moderately	82 (25%)	24 (30%)	
Satisfied	234 (73.13%)	51 (63.75%)	
Strongly satisfied	4 (1.25%)	4 (5%)	
Satisfaction on recruitment & selection (R & S)			
Moderately	13 (9.38%)	7 (8.75%)	Relationship of satisfaction between R & S and type of bank sustained ($p=0.02$).
Satisfied	282 (77.66%)	72 (90%)	
Strongly satisfied	25 (7.81%)	1 (1.25%)	
Satisfaction on financial benefits respective banking organizations			
Dissatisfied	1 (0.31%)	1 (1.25%)	H_a not supported ($p=0.39$). Association exists between financial benefits and bank type.
Moderately	87 (27.19%)	28 (35%)	
Satisfied	229 (71.56%)	50 (62.50%)	
Strongly satisfied	3 (0.94%)	1 (1.25%)	
Satisfaction on promotion and transfer policy of the sampled banks			
Strongly Dissatis.	1 (0.31%)	0 (0%)	There is highly relationship in case of satisfaction between promotion policy and nature of bank (p -value 0.05).
Dissatisfied	52 (16.25%)	5 (6.25%)	
Moderately	131 (40.94%)	45 (56.25%)	
Satisfied	132 (41.25%)	29 (36.25%)	
Strongly satisfied	4 (1.25%)	1(1.25%)	
Satisfaction on leave policy of the sampled banks			
Dissatisfied	2 (0.63%)	0 (0%)	H_a not confirmed ($p=0.79$). There is no relationship in case of satisfaction between leave policy and nature of bank.
Moderately	175 (54.69%)	42 (52.50%)	
Satisfied	139 (43.44%)	37 (46.25%)	
Strongly satisfied	4 (1.25%)	1(1.25%)	
Motivation regarding banking career & development (CD) paths			
Dissatisfied	5 (1.56%)	0 (0%)	No positive relationship regarding motivation between CD and bank type since $p=0.24$.
Moderately	122 (38.13%)	36 (45%)	
Satisfied	183 (57.19%)	40 (50%)	
Strongly satisfied	10 (3.13%)	4 (5%)	

5.3.5 Comparative Analysis on Satisfaction Level between Public and Private Banks

In this section the researcher attempted to show the comparison regarding the factors of employee satisfaction of the banks through using the Levene's Test of Means.

Table 5.21: Status of satisfaction between public and private bank

Satisfaction on	Public Bank		Private Bank		Levene's Test for Equality of Means			
	Mean	SD	Mean	SD	MD	F	Sig.	Sig. diff.
Present pay	3.76	0.46	3.73	0.57	0.03	7.86	0.610	Public>Private
<i>R & S*</i>	4.04	0.34	3.92	0.31	0.12	0.09	0.010	Public>Private
Finan_ benefits	3.73	0.47	3.64	0.53	0.09	7.52	0.120	Public>Private
<i>PromoTransfer**</i>	3.27	0.75	3.33	0.61	-0.06	6.26	0.010	Private> Public
<i>Leave policy</i>	3.45	0.53	3.49	0.53	-0.04	0.01	0.910	Private> Public
Career_develop	3.62	0.58	3.60	0.59	0.02	0.36	0.800	Public>Private
Overall_satis***	3.65	0.52	3.62	0.52	0.03	3.68	0.41	Not sig.

The survey from Table 5.21 shows that there is some difference of satisfaction and motivation between the employees of both the banks. Overall, the average R&S value of a public bank is higher than that of a private bank (MD is 0.03 and constant in SD 0.52). Recruitment and selection (*R&S*; $p=0.010$) and promotion and transfer policy ($p=0.010$) are statistically significant since p -value <0.05 . In that case alternative assumption (H_a) is statistically supported, thus, there is a highly association between promotion and employee satisfaction.

5.3.6 Exploratory Factor Analysis of Employee Satisfaction

Table 5.22: Descriptive analysis of satisfaction on existing opportunities

Descriptive Statistics:	Mean	SD	Test result
Present salary (Present_salary)	3.750	0.483	KMO=0.834 $\chi^2=758.033$ df.=15 Sig.=0.000 N=400 Cronbach's Alpha 0.81
Recruitment and selection (R&S)	4.015	0.339	
Financial benefits (Fin_benefits)	3.713	0.485	
Promotion and transfer policy (Promo_trans)	3.280	0.727	
Leave policy (leave policy)	3.460	0.533	
Career and development paths (Career_deve)	3.615	0.577	

Table 5.22 illustrates the adequacy of sampling KMO. KMO value 0.834 which is suitable for EFA with Principal Component Analysis (PCA) method. Also, Bartlett's Test of Sphericity is used to determine general multivariate distribution data. The output is significant at $p<0.05$, which means that the level of satisfaction is fairly true in the sampled banks. Employees were found to be extremely satisfied with the recruitment and selection policy. It is being observed that the employees are highly satisfied with recruitment and selection policy (average value was 4.015).

Table 5.23: EFA and total variance explained for satisfaction level of employees

Communalities: Satisfaction and motivation		Total Variance Explained				Remarks on loadings
		Initial (1.00) Eigenvalues		Extraction Sums of Squared Loadings		
Components	Extraction	Total	% of Variance	Total (>)	% of Variance	
1. Promo_trans	0.658	3.09>1.00	51.459	3.088	51.459	Loaded 51.50%
2. Career_deve	0.480	0.930	15.463	-	-	
3. Leave policy	0.39~0.40	0.735	12.245	-	-	
4. Fin_benefits*	0.335<0.40	0.475	7.909	-	-	
5. Present salary**	0.300<0.40	0.438	7.306	-	-	
6. R&S***	0.089<0.40	0.337	5.618	-	-	

& Extraction < 0.40. Total variance explained and loaded covering (1) 51.50%
 Compiled by author by using EFA with Principal Component Analysis (PCA).

Table 5.23 shows that the extraction values of the three components are > 40% the communality between 1 and 3 components out of the six factors. There is only one reason with Eigenvalues (*satisfaction on promotion was 3.089*) > 1.00. That is, this component was loaded highly and of total variance interpreted as Eigenvalues for employee satisfaction ~51.50% was covered. Thus, employees are not highly satisfied with the promotion and the transfer policy in the banks. In addition, the policy makers of banking institutions need to be considered for career development, leave policy, and financial benefits.

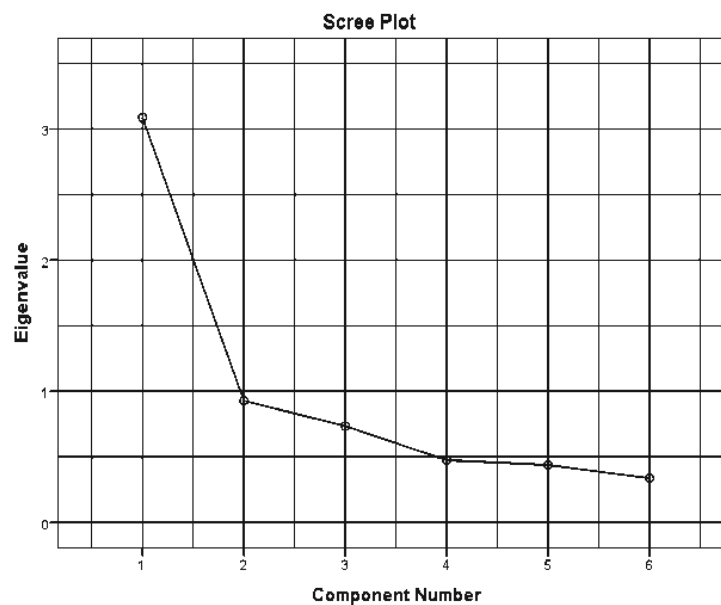

Figure 5.1: Scree plot of satisfaction factors

Figure 5.1 shows the scree of Eigenvalues and illustrates two factors are forming elbow-shaped and maximum percentage variation is explained in the graph. The top three communalities have been procured to ensure maximum satisfaction among the employees’ promotion, career development and leave policy are the most significant.

5.3.6 Measurement of SEM for Individual Factors of Employee Satisfaction

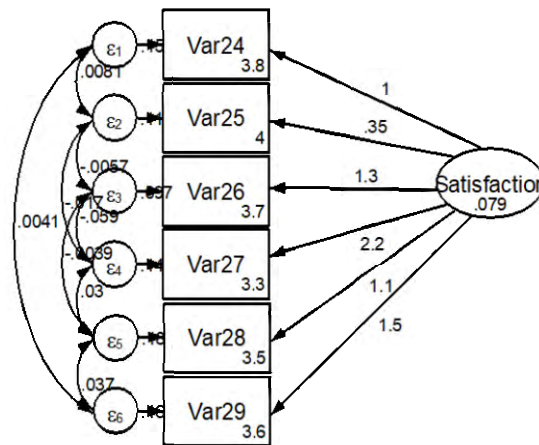

Figure 5.2: SEM of employee satisfaction

Figure 5.2 shows the measurement of SEM of employee satisfaction factors enjoying by public and private banks. The figure shows that the value of the coefficients for estimating the latent variable (0.079). The average value of all factors (24 to 29) is also displayed in SEM.

Table 5.24: Measurement for SEM of employee satisfaction

Particulars (Measurement)	Coef.	S.E	z	p>z	95% Conf. Interval	
Employee satisfaction (Latent variable-LF) in the banking sector of Bangladesh						
Var24 (Present_salary)	<-					
	1	(constrained)				
_cons	3.75	0.024	155.54	0.000	3.703	3.797
Var25 (R&S)	<-					
	0.35	0.104	3.37	0.001	0.147	0.556
_cons	4.015	0.017	237.1	0.000	3.982	4.048
Var26 (Fin_benefits)	<-					
	1.33	0.365	3.63	0.000	0.610	2.043
_cons	3.713	0.024	153.2	0.000	3.665	3.759
Var27 (Promo_transfer)	<-					
	2.229	0.612	3.64	0.000	1.030	3.428
_cons	3.28	0.036	90.40	0.000	3.209	3.351
Var28 (Leave policy)	<-					
	1.12	0.299	3.73	0.000	0.530	1.705
_cons	3.46	0.027	130.2	0.000	3.408	3.512

Var29 (Career_deve)	<-					
	1.49	0.133	11.18	0.000	1.230	1.753
_cons	3.62	0.029	125.5	0.000	3.558	3.671
var(e.Var24)	0.154	0.023			0.114	0.208
var(e.Var25)	0.105	0.008			0.090	0.122
var(e.Var26)	0.097	0.038			0.045	0.209
var(e.Var27)	0.136	0.104			0.031	0.608
var(e.Var28)	0.184	0.029			0.135	0.252
var(e.Var29)	0.157	0.047			0.088	0.281
var (Emplo_satisfaction; LF)	0.079	0.024			0.043	0.144
cov(e.Var24,e.Var25)	0.008	0.008	1.02	0.308	-0.007	0.024
cov(e.Var24,e.Var29)	0.004	0.031	0.14	0.892	-0.056	0.064
cov(e.Var25,e.Var26)	-0.006	0.010	-0.55	0.580	-0.026	0.014
cov(e.Var25,e.Var27)	-0.017	0.015	-1.15	0.250	-0.047	0.012
cov(e.Var26,e.Var27)	-0.059	0.061	-0.97	0.334	-0.179	0.061
cov(e.Var26,e.Var28)	-0.004	0.029	-0.13	0.895	-0.062	0.055
cov(e.Var27,e.Var28)	0.030	0.050	0.60	0.546	-0.068	0.128
cov(e.Var28,e.Var29)	0.037	0.015	2.45	0.014	0.007	0.066
obs = 400; Estimation method = ml; Log likelihood = -1413.7181; LR test of model vs. saturated: chi2(15) = 13.09, Prob > chi2 = 0.0003						

The above Table 5.24 shows material on how the SEM is quantified by listing the experimental variables with coefficient values of hidden factor *Employee satisfaction* ($\beta=0.079$) are satisfaction on pay ($\beta=1$ constrained), R & S ($\beta=0.35,<1$), financial benefits ($\beta=1.33$ i.e., >1), promotion and transfer ($\beta=2.229,>1$), HR leave policy ($\beta=1.12, >1$), and career and growth path ($\beta=1.49,>1$). Stata is estimating the model with the expected sample. The main part of output, the columns are equal to those presented for regression model.

Rows represent options to standardized factor loading, cut off, and measurement errors. The most important part of information in this part of the output is the standard factor loading listed by the coefficients. The column listed and the conforming p -values column listed in $p > |z|$. The p -values for all of the factor loadings are below the representative cut-off of .05, leading to the rejection of the null hypotheses that the factor loadings are equal to 0; hence, the loadings are statistically substantial. Their degrees need to be deduced to assess their empirical significance.

The study received identical factor loads because latent variable and model identification were determined *employee satisfaction* that has been set to 1 to measure. The homogeneous factor loading for promotion and transfer policy factor having coefficient value 2.229 which is >1 , denoting the standard deviation booms in *satisfaction* leads to a 2.229. The most important component of SEM is employee promotion and transfer for employee satisfaction.

Coefficient values of other factors close 1 or, >1 to effectively lead the model. Transfer the less effective factor to the model as the remainder of HR with beta coefficient is $0.35 < 1$

In the measurement chi-square value, $\chi^2 (15) = 13.09$, $\text{Prob} > \chi^2 = 0.0003$, is extremely statistically significant (p -value < 0.05) demonstrating the model replicates the observed co-variance among all. The null hypothesis (H_0) in case of model fits. The p -value of 0.000 is less than 0.05 stating that the null hypothesis is not. The overall model fits exceptionally well meaning that the latent variable quantified as *employee satisfaction* highly complementary to the all factors applied to extent it. The production also provides with $\chi^2 13.09$, with the df 15, and the significance of the χ^2 test (i.e. $p < 0.001$). Thus, Employee Motivation = f (Employee satisfaction). There is correlation between satisfaction and employee motivation in the sampled banks (developed from Table 5.24).

Table 5.25: Structural path analysis of satisfaction and motivation

Hypothesized Structural Path	p -value	Coeff	Relationship	Remarks
Motivation ← Satisfaction	0.000	0.079	H_a ; sustained	Highly related

It can be confirmed that there is highly relationship between satisfaction and motivation among the bank employees since p -value is < 0.05 (Table 5.25).

5.3.7 Effect of the Designation on Employee Satisfaction in the Banks

Employees are influenced by the status they enjoy in the banks. This study has examined empirically the effect of designation for which employees behave in the work place performance (Table 5.26-5.31). The χ^2 test statistic and Fisher's exact p -value have been used to justify the effect of the factors related to job satisfaction.

Table 5.26: Satisfaction level with present salary * present designation (equivalent)

Count	Supervisor	Officer	SO	PO	SPO	AGM	DGM	GM	Total
D	0	0	0	1	0	0	0	0	1
MS	3	45	36	16	6	0	0	0	106
S	0	50	82	73	55	18	5	2	285
HS	0	0	1	2	4	1	0	0	8
Total	3	95	119	92	65	19	5	2	400
HD= Highly dissatisfied; D= Dissatisfied; MS= Moderately satisfied; S= Satisfied; HS= Highly satisfied									
Remarks: χ^2 test statistic and Fisher's Exact p -value 0.000 which is < 0.05 i.e., significant. Thus, there is strong relationship between present status/ designation and present salary provided by the banks.									

Table 5.27: Satisfaction in recruitment and selection * present designation (equivalent)

Count	Supervisor	Officer	SO	PO	SPO	AGM	DGM	GM	Total
MS	1	10	4	3	1	1	0	0	20
S	2	84	107	82	60	14	4	1	354
HS	0	1	8	7	4	4	1	1	26
Total	3	95	119	92	65	19	5	2	400
HD= Highly dissatisfied; D= Dissatisfied; MS= Moderately satisfied; S= Satisfied; HS= Highly satisfied									
Remarks: Chi ² test statistic and Fisher's Exact <i>p</i> -value 0.000 which is < 0.05 i.e., significant. Therefore,									

Table 5.28: Satisfaction level on financial benefits * present designation (equivalent)

Count	Supervisor	Officer	SO	PO	SPO	AGM	DGM	GM	Total
D	0	1	0	1	0	0	0	0	2
MS	2	50	42	16	5	0	0	0	115
S	1	44	77	75	59	18	3	2	279
HS	0	0	0	0	1	1	2	0	4
Total	3	95	119	92	65	19	5	2	400
HD= Highly dissatisfied; D= Dissatisfied; MS= Moderately satisfied; S= Satisfied; HS= Highly satisfied									
Remarks: Chi ² test statistic and Fisher's Exact <i>p</i> -value 0.000 which is < 0.05 i.e., significant.									

Table 5.29: Satisfaction on promotion and transfer policy * present designation (Equi)

Count	Super	Officer	SO	PO	SPO	AGM	DGM	GM	Total
HD	0	0	1	0	0	0	0	0	1
D	2	25	24	6	0	0	0	0	57
MS	1	57	63	32	19	4	0	0	176
S	0	13	31	53	46	14	3	1	161
HS	0	0	0	1	0	1	2	1	5
Total	3	95	119	92	65	19	5	2	400
HD= Highly dissatisfied; D= Dissatisfied; MS= Moderately satisfied; S= Satisfied; HS= Highly satisfied									
Remarks: Chi ² test statistic and Fisher's Exact <i>p</i> -value 0.000 which is < 0.05 i.e., significant.									

Table 5.30: Satisfaction on leave policy * present designation (equivalent)

Count	Supervisor	Officer	SO	PO	SPO	AGM	DGM	GM	Total
D	0	1	0	1	0	0	0	0	2
MS	3	76	79	39	16	4	0	0	217
S	0	18	39	51	49	14	4	1	176
HS	0	0	1	1	0	1	1	1	5
Total	3	95	119	92	65	19	5	2	400
HD= Highly dissatisfied; D= Dissatisfied; MS= Moderately satisfied; S= Satisfied; HS= Highly satisfied									
Remarks: Chi ² test statistic and Fisher's Exact <i>p</i> -value 0.000 which is < 0.05 i.e., significant.									

Table 5.31: Motivation on career and development paths * present designation (Equi.)

Count	Supervisor	Officer	SO	PO	SPO	AGM	DGM	GM	Total
D	0	4	1	0	0	0	0	0	5
MS	3	65	61	21	8	0	0	0	158
S	0	26	56	67	54	16	3	1	223
HS	0	0	1	4	3	3	2	1	14
Total	3	95	119	92	65	19	5	2	400
HD= Highly dissatisfied; D= Dissatisfied; MS= Moderately satisfied; S= Satisfied; HS= Highly satisfied									
Remarks: Chi ² test statistic and Fisher's Exact <i>p</i> -value 0.000 which is < 0.05 i.e., significant.									

It has been confirmed that there does have a direct and significant effect of the present status or designation on satisfaction since p -value <0.05 (Table 5.26-5.31). So, present status of banks' employees influences the satisfaction and motivation.

5.4 Job Characteristics (JCM) Model and Employee Motivation

JCM may be considered for working design of a job smoothly performed by the staff. Job Characteristics Model (JCM) recognizes the conditions required to give motivation for existing employees in order to maximizing job performance. JCM suggests five core job characteristics such as skill variety, task identity, task significance, autonomy and feedback leading to the Critical Psychological States-CPS (i.e., work meaningfulness, responsibility and results of actual work done) then increases positive behavioural performance as like-high job performance and satisfaction or motivation.⁴

5.4.1 Statistical Analysis on JCM

Table 5.32: Skill variety for same position in the bank

Perception	Freq.	%	Remarks
Strongly disagree	1	0.3	From Table 5.32 the study found that 74% (maximum) of the employees agreed positively that the sampled banks created the position with skill varieties.
Disagree	9	2.3	
Moderately agree	65	16.3	
Agree	296	74.0	
Strongly agree	29	7.3	
Total	400	100.0	

Table 5.33: Task identity due to job performance in the bank

Perception	Freq.	%	Remarks
Moderately agree	24	6.0	Table 5.33 shows that 68.5% (highest) of the respondents approved positively that task identity affects the job performance practiced in the sampled banks.
Agree	274	68.5	
Strongly agree	102	25.5	
Total	400	100.0	

Table 5.34: Task significances due to do the job perfectly

Perception	Freq.	%	Remarks
Disagree	2	0.5	Table 5.34 explains that majority (53% and 38.5%) of the participants positively approved that the sampled banks signified the different tasks among employees.
Moderately agree	32	8.0	
Agree	212	53.0	
Strongly agree	154	38.5	
Total	400	100.0	

⁴ J. Richard Hackman and Greg R. Oldham, "Development of the Job Diagnostic Survey", *Journal of Applied Psychology*, 1976, Vol. 93: 108-124, DOI: 10.1037/0021-9010.93.1.108

Table 5.35: Autonomy of the job responsibility is available

Perception	Freq.	%	Remarks
Strongly disagree	83	20.8	Table 5.35 shows 35.3% of respondents moderately agreed that job autonomy practiced in the sampled banks. It is also observed that freedom of doing job was not completely available.
Disagree	110	27.5	
Moderately agree	141	35.3	
Agree	59	14.8	
Strongly agree	7	1.8	
Total	400	100.0	

Table 5.36: Job feedback from immediate authority

Perception	Freq.	%	Remarks
Strongly disagree	1	0.3	From Table 5.36 researcher observed that 67.3% (highest) of the respondents strongly approved that employees getting feedback from immediate authority.
Disagree	1	0.3	
Moderately agree	12	3.0	
Agree	117	29.3	
Strongly agree	269	67.3	
Total	400	100.0	

5.4.2 Pearson Correlation among the Elements of JCM with Demographic Outlines

Table 5.37: Pearson's correlation matrix (N=400)

Variables	1	2	3	4	5	6	7	8
1. Skill variety (SV)	1							
2. Task identity (TI)	0.283**	1						
3. Task significant (TS)	0.262**	0.504**	1					
4. Autonomy (Auto)	0.170**	0.150**	0.119*	1				
5. Job feedback (JF)	0.150**	0.293**	0.332**	0.087	1			
6. Designation	0.202**	0.132**	0.197**	0.271**	0.104*	1		
7. Gender	(-0.007)	(-0.024)	(-0.037)	0.036	(-0.053)	(-0.099*)	1	
8. Type of bank	0.103*	(-0.078)	(-0.085)	0.101*	(-0.047)	0.084	(-0.071)	1

Table 5.37 shows that there is a concerned to positive correlation between employee designation and JCM variables from 1 to 4 and 5 respectively at 50% and 10% level of significance ($r = 0.202$, $r = 0.132$, $r = 0.197$, $r = 0.271$, and $r = 0.104$). In terms of gender there is only a positive correlation with job autonomy ($r = 0.036$), and other factors ($r = -0.007$, $r = -0.024$, $r = -0.037$ and $r = -0.053$) are negatively related. Again the significant positive relationship is observed between type of bank (public and private bank) and skill variety ($r=0.103$) and autonomy ($r = 0.101$) at 10% level of significant. Task identity ($r = -0.078$), task significance ($r = -0.085$) and job feedback ($r = -0.047$) are very weak and negative relation with types of public and private bank. It also observed that a significant relation exist between task significances ($r = 0.504$) and task identity at 5% level of significance.

5.4.3 Measurement of Motivating Potential Score (MPS) and Designation

In this section researcher has measured MPS involved in JCM and compared with Officer Level (Supervisor to SPO) and Executive Level (AGM to GM) for showing the satisfaction level of the job designed (characteristics) in the banks.

Table 5.38: Measuring MPS: $(SV+TI+TS)/3*(Autonomy * Feedback) * Designation$

Designation		Skill variety	Task identity	Task significance	Autonomy	Feedback	MPS
Supervisor	Mean	3.333	4.000	3.667	2.333	5.000	42.777
	Std. Dev.	1.155	0.000	0.578	1.528	0.000	
Officer	Mean	3.737	4.158	4.179	2.358	4.590	43.552
	Std. Dev.	0.639	0.552	0.743	1.021	0.660	
Senior officer	Mean	3.815	4.160	4.269	2.277	4.613	42.878
	Std. Dev.	0.624	0.521	0.620	0.892	0.584	
PO/EO	Mean	3.913	4.163	4.283	2.370	4.522	44.138
	Std. Dev.	0.568	0.520	0.542	1.097	0.602	
SPO/AVP	Mean	3.939	4.246	4.400	2.800	4.708	55.295
	Std. Dev.	0.242	0.501	0.553	0.955	0.492	
A. Overall officer level (Supervisor to SPO) MPS value							228.64
AGM	Mean	4.105	4.474	4.684	3.526	5.000	77.950
	Std. Dev.	0.459	0.513	0.583	0.772	0.000	
DGM	Mean	4.200	4.600	4.800	4.000	5.000	90.667
	Std. Dev.	0.447	0.548	0.447	0.000	0.000	
GM	Mean	4.500	4.500	4.500	4.000	5.000	90.000
	Std. Dev.	0.707	0.707	0.707	0.000	0.000	
B. Executive level (AGM to GM) MPS value							258.62
Total	Mean	3.858	4.1950	4.2950	2.4925	5.000	51.294
	Std. Dev.	0.573	0.527	0.632	1.033	0.000	
Remarks: Officer level MPS is fewer than Executive level i. e., $228.64 < 258.62$; $B > A$							

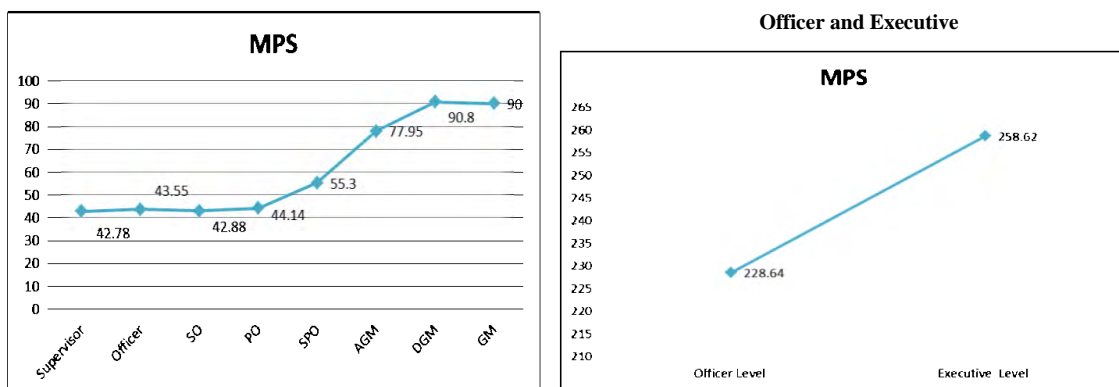

Figure 5.3: MPS between officer and executive

The Table 5.38 showing the average MPS value of supervisor 42.777, officer 43.552, SO 42.878, PO 44.138, SPO 55.295, AGM 77.950, DGM 90.667 and GM 90.00. It is also observed that average MPS value of higher level executives is greater than that of lower level employees. Therefore, the higher level employees are more satisfied than the lower level employees (Figure 5.3).

5.4.4 MPS and Gender

The value of MPS has been compared with male and female employees for showing the motivational perception.

Table 5.39: Measuring MPS *crosstabs by gender

Gender		Skill variety	Task identity	Task significance	Autonomy	Feedback	MPS
Male	Mean	3.859	4.201	4.305	2.476	4.644	47.392
	Std. Dev.	0.587	0.536	0.636	1.053	0.587	
Female	Mean	3.849	4.168	4.242	2.576	4.561	47.997
	Std. Dev.	0.504	0.483	0.609	0.929	0.558	
Total	Mean	3.854	4.185	4.274	2.526	4.603	47.695
	Std. Dev.	0.546	0.510	0.623	0.991	0.573	

The Table 5.39 shows that the scores of average MPS values relating to gender (Average MPS value of male 47.392 and female 47.997) are almost same. This is why, it can be said that there is no significant satisfaction difference between male and female employees in the banks.

5.4.5 Comparison MPS between Public and Private Bank

Table 5.40: Measuring MPS *crosstabs by nature of banks

Type of bank		Skill variety	Task identity	Task significance	Autonomy	Feedback	MPS
Public bank	Mean	3.828	4.216	4.322	2.441	4.644	46.716
	Std. Dev.	0.591	0.532	0.633	1.018	0.575	
Private bank	Mean	3.975	4.113	4.188	2.700	4.575	50.542
	Std. Dev.	0.477	0.503	0.618	1.072	0.612	
Total	Mean	3.902	4.165	4.255	2.571	4.700	48.629
	Std. Dev.	0.534	0.518	0.626	1.369	0.594	

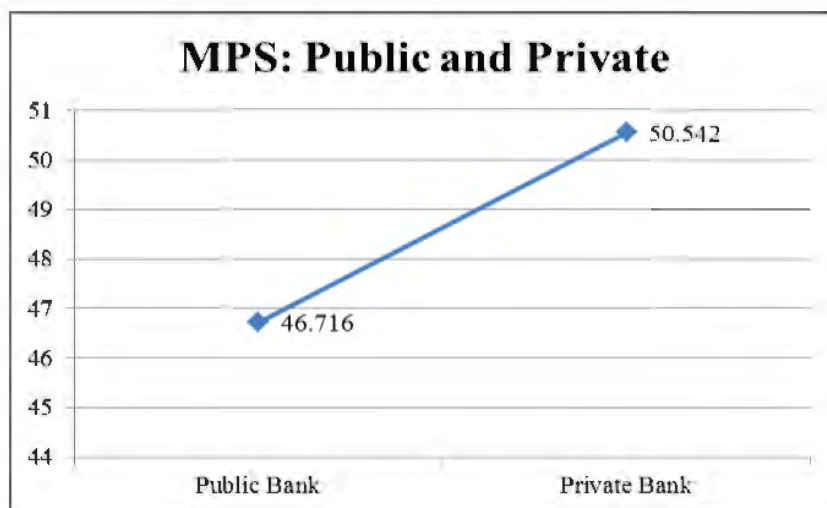

Figure 5.4: MPS between public and private banks

Type of bank (Table 5.40) showing the result of MPS of public bank is 46.716 and private bank is 50.524. Here, the MPS of private bank is more than public bank (Figure 5.4) implies that private bank employees are more satisfied than public bank employees.

5.4.6 Impact of MPS on Employee Motivation in terms of Designation, Gender and Types of Bank

The impact of MPS on employee motivation constructed from the above from Table 5.41-5.43.

Table 5.41: MPS results and effect on motivation

Result	Controlled	Variation	Impact on motivation
MPS	Designation	Observed	Higher levels employees are highly motivated.
MPS	Gender	Not observed	Male and female employees' motivation is constant.
MPS	Types of Bank	Observed	Private bank employees' motivation is somewhat other than public bank.

5.4.7 Comparative Analysis of JCM Practices between the Public and Private Bank

Table 5.42: Comparison of JCM practices between the sampled banks

JCM	Public bank		Private bank		Levene's test for equality of variances			Observed
	Mean	SD	Mean	SD	MD	F	p-value	
Skill variety	3.828	0.591	3.975	0.477	-0.147	9.192	0.003	$p < \alpha$
Task identity	4.216	0.532	4.113	0.503	0.103	5.195	0.023	
Task significance	4.322	0.633	4.188	0.618	0.134	7.704	0.006	
Autonomy	2.441	1.018	2.700	1.072	-0.259	0.938	0.938^a	$p > \alpha$
Job feedback	4.644	0.575	4.575	0.612	0.069	2.254	0.134^b	
Average output	3.89	0.670	3.79	0.656	0.10		0.221^c	

SD = Standard deviation; MD = Mean difference ; 95% confidence interval of the difference; Sig. (2-tailed); Insignificant^{a,b,c}

The Table 4.42 depicts that the public bank is less than the mean value of private bank in terms of skill variety and autonomy and the remaining the three factors are more than the mean value of private bank ($p < 0.05$). The first three dimensions of JCM having significant relationship with the job design. On the other hand, it has been observed that average result ($p = 0.221^c$ $p > 0.05$) is not statistically significant. Average output of mean (MD = 0.10) is higher than that of the private bank in the study area but the difference is insignificant.

5.4.8 EFA for JCM and Demographic Factors

Table 5.43: Descriptive analysis and test result for EFA in JCM and demographic factors

JCM and demographic factors	Mean	SD	Results and remarks
Skill variety (SV)	3.858	0.573	KMO = 0.695 ~ (.70) $\chi^2 = 305.65$ df = 28 p-value = 0.000; (N = 400); Method: PCA Remarks: Data are good and fit for EFA
Task identity (TI)	4.195	0.527	
Task significance (TS)	4.295	0.632	
Autonomy (Auto)	2.493	1.033	
Job feedback (JF)	4.630	0.582	
Gender (Gen)	1.165	0.372	
Present designation (PD)	5.505	1.319	
Type of bank (TB)	1.200	0.401	

Kaiser-Meyer-Olkin (KMO) test: This measure varies between 0 and 1, and the values closer to 1 are better. In this study the KMO is 0.70 suggested the collected data are suitable for EFA (Table 4.43). KMO measuring sampling adequacy is applicable method for data appropriateness for EFA. Kaiser (1974)⁵ suggested that values < 0.50 miserable/unacceptable, > 0.50 are acceptable, values between 0.50 -0.70 are mediocre, 0.70 – 0.80 are good, 0.80 – 0.90 are excellent. Mean values (MV~4.3 and 5.51) of task significance and present designation are the highest score. Bartlett's Test of Sphericity: Here identity matrix closes all of the diagonal elements are 1 and all of off diagonal elements are 0. The test provides a minimum standard which should be applied before an EFA or principal components analysis conducted. This test is highly significant (p-value = 0.000) at 5% level of significance.

Table 5.44: EFA and total variance explained of JCM on employee motivation

Communalities: JCM and demographic			Total variance explained				Remark: highly loadings
			Initial (1.00) Eigenvalues		Extraction sums of squared loadings		
Components	Initial	Extraction	Total	% of Variance	Total (>1)	% of Variance	
1. TS	1.000	0.791	2.138	26.720	2.138	26.720	Loaded 55.5% ~56%
2. TI	1.000	0.769	1.268	15.844	1.268	15.844	
3. JF	1.000	0.638	1.038	12.978	1.038	12.978	
4. Auto	1.000	0.081	0.897	11.217	<0.40	-	-
5. PD	1.000	0.173	0.796	9.945	<0.40	-	-
6. TB	1.000	-0.326	0.706	8.824	<0.40	-	-
7. SV	1.000	0.380	0.676	8.449	<0.40	-	-
8. Gen.	1.000	-0.080	0.482	6.023	<0.40	-	-

Extraction values of components (1 to 3) are >0.40⁶. Total variance explained and loaded covering ~56%.

⁵ Henry F. Kaiser, "An Index of Factorial Simplicity", *Psychometrika*, 1974, Vol. 39: 31-36.

⁶ A.S. Gaur, and S.S. Gaur, "Researchers commonly use a cut-off of 0.40 to identify high loadings", *Statistical Methods for Practice and Research*, second edition (Response Books: New Delhi, India, 2009):143.

Communalities: This is the ratio of each variable's variance explaining by the factors e.g., the underlying latent continua and also noted as h^2 and can be defined as the sum of squared factor loadings for the variables.

Initial: The initial Eigenvalues (2.14 + 1.27 + 1.04) on the diagonal of the correlation matrix are determined by the squared multiple correlation of the variable with the other variables (Table 5.44). Three components have the Eigenvalues are greater than initial value 1.00. Extraction: Task significances, task identity and job feedback due to do the jobs perfectly are explained 56% (26.72 + 15.84 + 12.98) by the total variance and highly loaded. Therefore, bank authority can rethink about the loaded three factors for employee motivation.

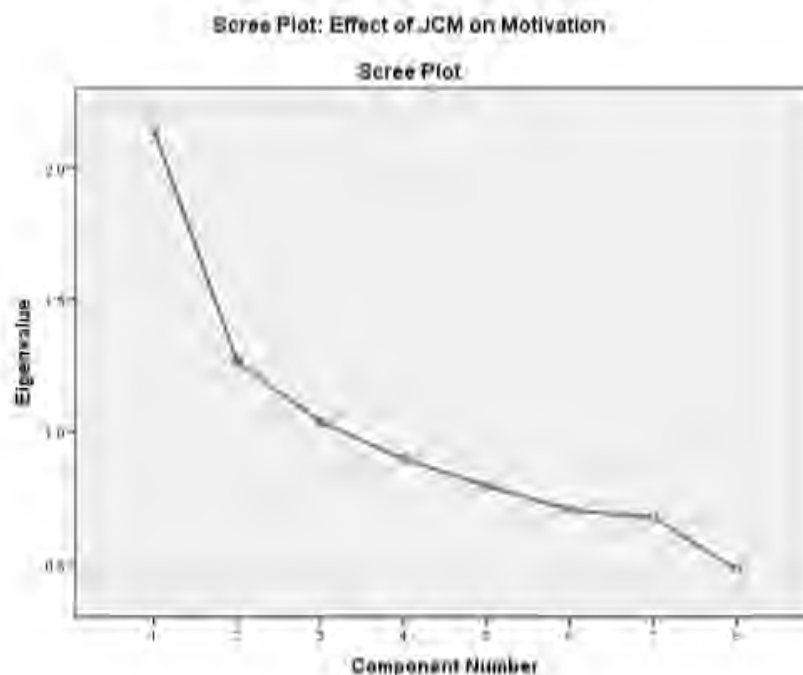

Figure 5.5: Scree plot: job characteristics model (JCM)

The scree plot graphs (Figure 5.5) the Eigenvalues against the factor/component number. From the scree plot it is shown that the three factors has been made elbow shape in the graph and high proportion of variance being explained. Then the top three extracted communalities i.e., task significance, task identity and job feedback are significant in this study of JCM model which affects employee motivation.

5.4.9 Exploring the Effective Factors of JCM Using Structural Equation Model

In this section it has applied SEM to explore latent and the most effective factors of satisfaction in the banks (Table 5.48-5.49 and Figure 5.6).

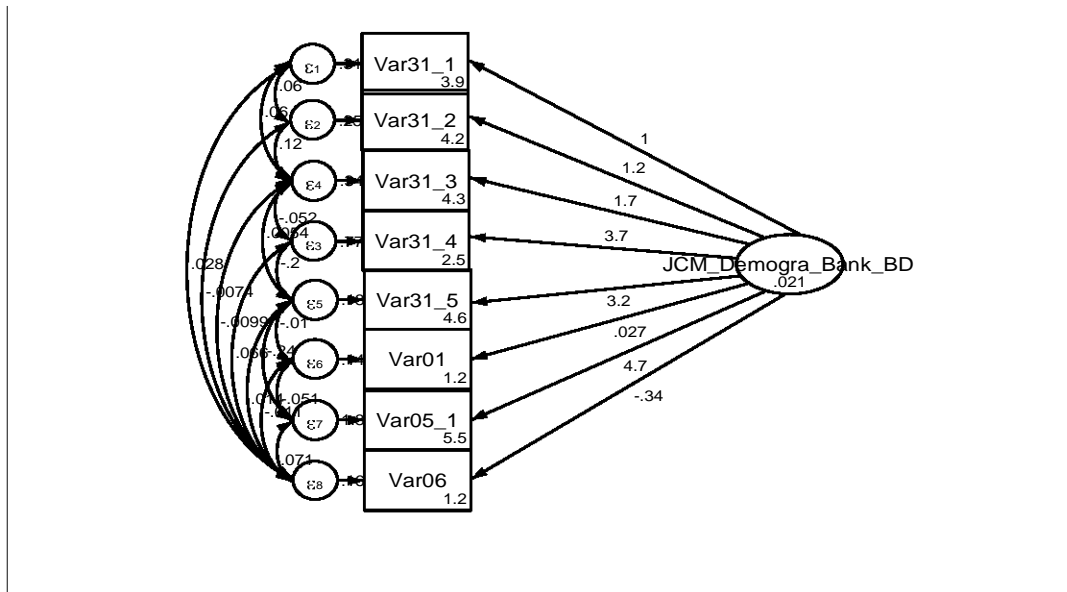

Figure 5.6: SEM of JCM & demographic outlines

Figure 5.6: SEM and coefficient paths for CFA of JCM (LF, $\beta=0.021$) as well as demographic factors. It also shows the mean and coefficient values of all factors of JCM (31.1 to 31.5) with demographic factors (1, 5.1 and 6).

Table 5.45: Measurement for SEM on JCM and demographic outlines

Measurement	Coef.	Std. Err.	z	p > z	95% Conf. Interval	Remarks
Job characteristics model (Latent variable)						
Var31.1_SV	<-					JCM, Coeffi. 1.605; p<0.05. Here, the most effective factors are autonomy and feedback .
	1	(constrained)				
_cons	3.86	0.029	134.88	0.000	3.80 3.91	
Var31.2_TI	<-					
	1.19 (β_1)	0.275	4.33	0.000	0.65 1.73	
_cons	4.2	0.026	159.42	0.000	4.14 4.25	
Var31.3_TS	<-					
	1.69 (β_2)	0.549	3.07	0.002	0.61 2.76	
_cons	4.3	0.032	136.22	0.000	4.23 4.36	
Var31.4_Autonomy	<-					
	3.74 (β_3)	1.354	2.76	0.006	1.09 6.40	
_cons	2.5	0.052	48.31	0.000	2.39 2.59	
Var31.5_Feedback	<-					
	3.17 (β_4)	1.618	1.96	0.05	-0.00 6.34	
_cons	4.63	0.029	159.34	0.000	4.57 4.69	
Demographic factors (Latent variable)						
Var01.Gender	<-					Designation ($\beta_5 > I$) is the most and less
	0.03 (β_5)	0.206	0.13	0.895	-0.38 0.43	
_cons	1.17	0.019	62.77	0.000	1.13 1.20	

Var05_ <i>Designation</i>	<-						
	4.74 (β_6)	1.621	2.92	0.003	1.56	7.92	
_cons	5.51	0.066	83.59	0.000	5.38	5.63	
Var06_ Bank Type	<-						
	-0.34 (β_7)	3788	-0.000	1.000	-7425	7424	
_cons	1.2	0.020	60.07	0.000	1.161	1.240	
var (e.Var31_1)	0.306	0.023			0.263	0.356	JCM
var (e.Var31_2)	0.247	0.020			0.212	0.289	
var (e.Var31_3)	0.338	0.036			0.274	0.416	
var (e.Var31_4)	0.770	0.109			0.583	1.016	
var (e.Var31_5)	0.127	0.108			0.023	0.680	
var (e.Var01)	0.138	0.010			0.120	0.158	Demo.
var (e.Var05_1)	1.262	0.176			0.960	1.658	
var(e.Var06)	0.157	47.60			0.000	67	
var (JCM)	0.021	0.012			0.007	0.066	

Log likelihood= -2868; Estimation method = ml; LR test of model vs. Saturated: chi2 (χ^2), (df = 8) = "7.80, Prob > chi2 = 0.0994,"Prob > chi2 = 0.0994; obs = 400; OIM.

The results (Table 5.45) showed that the standardized loadings factors values for each of the eight observed variables as well as their standard error, significance, and confidence intervals. The standardized factor loading for Var31_2 onto the latent construct JCM was β_1 1.19 with a standard error of 0.28. It is significant at $p < 0.001$ and had a 95% confidence interval that ranged from 0.65 to 1.73. Among the all factors Var01 (Gender) and Var06 (Type of Bank) are not statistically significant at 5% level of significance, all other factors look good. It has found that there were the most significant and strong effective factors of motivation in the latent variables explicitly autonomy ($\beta = 3.74$), feedback ($\beta = 3.17$), and designation ($\beta = 4.74$) in the model since the coefficient (β) values are >1 . The remaining three factors included in JCM which are skill variety, task identity and task significant confirm the highly influential factors due to β values >1 . Therefore, the equation, Motivation = f (JCM).

Table 5.46: Path coefficients of JCM and demographic factors

Hypothesized equation path	Coeff.	p-value	Remarks	Effect
Motivation <- JCM (overall)	0.012	0.000	Ha_1 ; Supported	Direct effect
Designation <- JCM	1.262	0.003	Ha_2 ; Supported	Direct effect
Gender <- JCM	0.138	0.895	Ha_3 ; Rejected	Indirect effect
Type of bank <- JCM	0.157	1.00	Ha_4 ; Rejected	Indirect effect

The structural equation model delineates the study that there is a significant direct effect between JCM and motivation with designation in the sampled banks (Table 5.46) (Ha_1 and Ha_2). On the other hand, structural model shows that gender with type of bank affecting indirectly employee motivation (Ha_3 and Ha_4).

5.5 Factors Relating to Employee Motivation in the Banking Sector

5.5.1 Statistical Analysis on the Hygiene and Motivational Factors

In this section descriptive and inferential statistics have been used to analyze the factors of motivation. The factors have been extracted from the motivation theories especially Two-Factor representing the content theories of the behavioral approaches in management thought (Table 5.50- 5.64).

Table 5.47: Salary meeting basic needs like food, residence, clothing

Perception	Freq.	%	Remarks
Often	84	21.0	From the Table 5.47 the study observed that majority (66%) of the respondents opined that basic salary they are paid is very often to meet the fundamental needs. Employees are moderately satisfied with basic salary.
Very often	264	66.0	
Always	52	13.0	
Total	400	100.0	

Table 5.48: Job security

Perception	Freq.	%	Remarks
Sometimes	7	1.8	Table 5.48 elucidates that 65.3% of the employees acknowledged that their job security level was true level.
Often	37	9.3	
Very often	261	65.3	
Always	95	23.8	
Total	400	100.0	

Table 5.49: Good relationship among colleagues

Perception	Freq.	%	Remarks
Sometimes	1	0.3	Table 5.49 shows that 77.3% (highest) of the respondents felt themselves as a good relationships among colleagues.
Often	4	1.0	
Very often	309	77.3	
Always	86	21.5	
Total	400	100.0	

Table 5.50: Bank policy and administration

Perception	Freq.	%	Remarks
Never	20	0.5	It has been noticed that majority of the participants approved that the bank policy and administration was in extent of practices in the sampled banks (Table 5.50).
Sometimes	24	6.0	
Often	71	17.8	
Very often	258	64.5	
Always	45	11.3	
Total	400	100.0	

Table 5.51: Employee participation is considered for decision making

Perception	Freq.	%	Remarks
Never	101	25.3	Table 5.51 explains that about 39% (highest) of the respondents opined that they do not have strong participation in decision making. It was also observed that banks' employees engaged the prescriptive operations.
Sometimes	155	38.8	
Often	94	23.5	
Very often	46	11.5	
Always	4	1.0	
Total	400	100.0	

Table 5.52: Job is interesting, prestigious, status, power and egoistic/ self-esteem

Perception	Freq.	%	Remarks
Sometimes	6	1.5	From the Table 5.52 researcher perceived that 79.5% of the employees in the sampled banks do feel moderately their job is prestigious and egoistic.
Often	30	7.5	
Very often	318	79.5	
Always	46	11.5	
Total	400	100.0	

Table 5.53: Promotion and growth at higher level available in the bank

Perception	Freq.	%	Remarks
Never	6	1.5	Table 5.53 clarifies that 52% (majority) of the respondents approved at extent or true level that upgradation and growth opportunities available in the sampled banks.
Sometimes	47	11.8	
Often	89	22.3	
Very often	208	52.0	
Always	50	12.5	
Total	400	100.0	

Table 5.54: Recognition and reward

Perception	Freq.	%	Remarks
Sometimes	1	0.3	Table 5.54 shows that 80.3% of the participants agreed positively that sampled banks recognized and rewarded employees' better performance.
Often	41	10.3	
Very often	321	80.3	
Always	37	9.3	
Total	400	100.0	

Table 5.55: Advancement in taking challenging performance

Perception	Freq.	%	Remarks
Sometimes	8	2.0	From Table 5.55 the study found that 74.3% of the respondents granted positively that employees have chances of advancement through taking challenges in the sampled banks.
Often	43	10.8	
Very often	297	74.3	
Always	52	13.0	
Total	400	100.0	

5.5.2 Scoring of Motivation Level Based on Frequency Distribution

Table 5.56: Scores of high, moderate, and low motivation level (> median= 0.50%)

Motivational factors	High	Moderate	Low	Remarks
Meeting basic needs	316 (79%)	84 (21%)	0%	It is clear that employees of the banks are dissatisfied in case of participation.* motivation is existed in all the remaining advantages.
Job security	356 (89%)	37 (9.3%)	7 (1.8%)	
Good relationship	359 (98.8%)	4 (1%)	1 (0.3%)	
Bank policy & admin	303 (76%)	71 (17.8%)	44 (11%)	
Employee participation*	50 (13%)	94 (23.5%)	256 (64%)	
Job prestigious & power	364 (91%)	30 (7.5%)	6 (1.5%)	
Promotion and growth	258 (65%)	89 (22.3%)	53 (13.3%)	
Recognition and reward	358 (90%)	41 (10.3%)	1 (0.3%)	
Advancement & challenging	349 (87%)	43 (10.8%)	8 (2)	

From the above descriptive analysis (Table 5.47-5.56) it is clear that banks' employees extremely dissatisfied with the participation. The other factors show a high

level realization of their basic needs. Comparatively employee will face challenges in promotion and enhancing the practices of private banks particular.

5.5.3 Bivariate Analysis on Motivational Factors by Crosstabs of Bank Types

Table 5.57: Correlation of motivation level by crosstabs of nature of bank

Perception	Public Bank	Private Bank	Chi-square Test and Fisher's Exact <i>p</i> -value
Salary meeting basic needs like food, residence, clothing			
Often	58 (18%)	26 (32.5%)	It is being got, $p=0.018<0.05$; H_a is accepted. Relationship between basic salary and motivation presents.
Very often	218 (68%)	46 (58%)	
Always	44 (14%)	8 (10%)	
Job security			
Sometimes	0 (0%)	7 (9%)	Since $p=0.000<0.05$; H_a is sustained. Therefore, a high relationship between job security and employee motivation of the banking sector.
Often	7 (2%)	30 (38%)	
Very often	221 (69%)	40 (50%)	
Always	92 (29%)	3 (4%)	
Good relationship among colleagues			
Sometimes	1 (0.31%)	0 (0%)	The p -value is $0.118>0.05$; H_a is not accepted. Insignificantly colleague relationship influence motivation in the sampled banks.
Often	2 (0.63%)	2 (3%)	
Very often	242 (76%)	67 (84%)	
Always	75 (23%)	11 (13.75%)	
Bank policy and administration			
Never	2 (0.63%)	0 (0%)	Since $p=0.273>0.05$; H_a is not supported. There is no association of bank policy and administration in terms of employee motivation.
Sometimes	20 (6.25%)	4 (5%)	
Often	62 (19%)	9 (11.25%)	
Very often	199 (62%)	59 (74%)	
Always	37 (11.56%)	8 (10%)	
Employee participation is considered for decision making			
Never	88 (28%)	13 (16%)	Got p -value 0.030. H_a failed to reject. There is positive relationship in case of satisfaction between promotion policy and type of bank.
Sometimes	125 (39%)	30 (38%)	
Often	75 (23.34%)	19 (24%)	
Very often	29 (9.1%)	17 (21%)	
Always	3 (0.94%)	1 (1%)	
Job is interesting, prestigious, status, power and egoistic/ self-esteem			
Sometimes	4 (1.25%)	2 (3%)	Since $p=0.852$; H_a not accepted. There is no relationship in case of satisfaction between leave policy and type of bank.
Often	24 (7.5%)	6 (8%)	
Very often	254 (79.38%)	64 (80%)	
Always	38 (11.88%)	8 (10%)	
Promotion and growth at higher level available in the bank			
Never	6 (1.88%)	0 (0%)	Found that $p=0.063>0.05$; H_a is rejected. Promotion and growth at higher level insignificantly influence employee satisfaction level in the sampled banks.
Sometimes	42 (13.13%)	5 (6%)	
Often	73 (22.81%)	16 (20%)	
Very often	157 (49%)	51 (63.75%)	
Always	42 (13.13%)	8 (10%)	
Recognition and reward			
Sometimes	1 (0.31%)	0 (0%)	It is observed, $p=0.014<0.05$; H_a is sustained. There is a strong association between recognition and fair reward among employees in the banks.
Often	26 (8.13%)	15 (19%)	
Very often	259 (80.94%)	62 (77.5%)	
Always	34 (10.63%)	3 (4%)	
Advancement in taking challenging performance			
Sometimes	8 (2.5%)	0 (0%)	Since $p=0.247>0.05$. H_a not supported. Therefore, chances of attainment top position insignificantly influence motivation in the banking sector of Bangladesh.
Often	33 (10.31%)	10 (13%)	
Very often	236 (73.75%)	61 (76%)	
Always	43 (13.44%)	9 (11.25%)	

5.5.4 Exploratory Factor Analysis on Hygiene and Motivating Factors

Table 5.58: Descriptive statistics and test result for EFA of motivational factors

Motivating factors	Mean	SD	Test Results
Basic need	3.920	0.578	KMO=0.803 Cronbach's Alpha = 0.76 $\chi^2=824.769$ df.=36 Sig.=0.000, ($p<0.05$) N=400 Extraction Method: PCA Data are excellent and fit for EFA
Job security	4.110	0.624	
Relationship among colleagues	4.200	0.442	
Policy and administration	3.800	0.732	
Employee participation	2.243	0.991	
Self-esteem and interesting job	4.010	0.501	
Promotion and Growth	3.623	0.901	
Recognition and equitability	3.985	0.453	
Advancement and achievement	3.983	0.564	

The Table 5.58 depicts that the sampling adequacy is explained by applying KMO. The KMO value is 0.803 which is fit and suitable for EFA. In addition, Bartlett's Test of Sphericity is used to determine data for normal multivariate distribution. The output is significant at $p<0.05$, so it can meet the proposition of regular multivariate analysis and distribution.

Table 5.59: EFA and total variance explained for motivating factors

Communalities: Motivating factors		Total Variance Explained				
		Initial (1.00) Eigenvalues		Extraction Sums of Squared Loadings		
Components (Initial values of all components were 1.00)	Extraction	Total	% of Variance	Total (>1.00)	% of Variance	
1. Advancement	0.666	3.330	37.002	3.330	37.00	Loaded 51%
2. Promotion and Growth	0.646	1.248	13.868	1.248	13.87	
3. Relationship	0.625	0.919	10.211	-	-	
4. Job security	0.551	0.858	9.528	-	-	
5. Meeting basic need	0.546	0.658	7.315	-	-	
6. Participation	0.454	0.635	7.059	-	-	
7. Esteem and interesting*	0.376	0.496	5.506	-	-	
8. Recognition**	0.372	0.449	4.994	-	-	
9. Policy and admin***	0.342	0.407	4.517	-	-	
&* Extraction < 0.40. Total variance explained and loaded covering (1+2) ~51%						

Table 5.59 shows that extraction values of five components are more than 50% the communality from 1 to 5 components > 0.5 out of the nine factors. There are two factors with Eigenvalues (i.e., advancement 3.330 and promotion 1.248) more than 1.00. That means, these two components are highly loaded and covered ~51% (37.002+13.868) of the total variance explained as Eigenvalues for employee satisfaction. Therefore, employees have intent to reach the highest level (advancement) along with receiving promotion. Besides, the initial total Eigenvalues of motivating four factors are 5.523 (61.37%) and five hygiene factors are 3.477 (38.63%) explained.

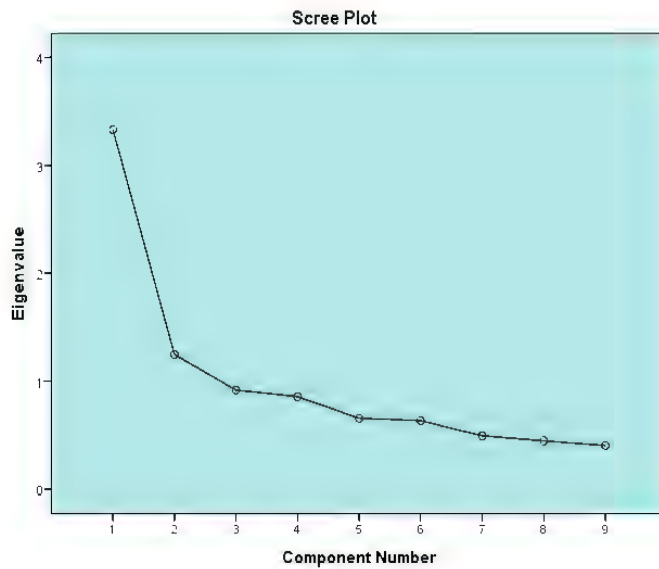

Figure 5.7: Scree plot on motivating factors

Figure 5.7 shows the scree plot of Eigenvalues and depicting two factors are forming elbow-shaped and maximum proportion variance is explained in the graph. The top two communalities have been extracted i.e., advancement and achievement and promotion and growth are significant in the study.

5.5.5 Measurement of Structural Equation Modeling (SEM) for Individual Factors of Motivation

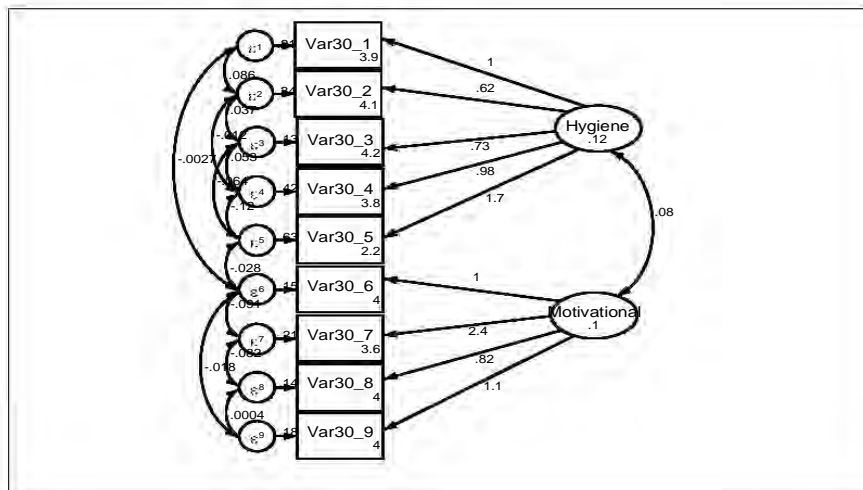

Figure 5.8: SEM of hygiene and motivational factors

Figure 5.8 shows a SEM constructs of the hygiene (LF1, $\beta=0.12$) and motivational factors (LF2, $\beta=0.10$) entertaining by the banks. It is being observed in the figure that the coefficient values for estimation of all factors (30.1 to 31.9) shown in the houses.

Table 5.60: Measurement for SEM on maintenance and motivating factors

Particulars (Measurement)	Coef.	S.E	z	p>z	95% Conf. Interval	
Hygiene or Maintenance Factors of Motivation (Latent factor: LF1)						
Var30_1 (Meeting basic need)	<-					
	1	(constrained)				
_cons	3.92	0.029	135.7	0.000	3.863	3.977
Var30_2 (Job security)	<-					
	0.62	0.104	5.89	0.000	0.416	0.823
_cons	4.11	0.031	132.8	0.000	4.049	4.171
Var30_3 (Staff relationship)	<-					
	0.73	0.095	7.67	0.000	0.541	0.913
_cons	4.2	0.022	190.8	0.000	4.157	4.243
Var30_4 (HR policy & admin)	<-					
	0.98	0.155	6.29	0.000	0.672	1.280
_cons	3.8	0.037	103.8	0.000	3.728	3.871
Var30_5 (Participation)	<-					
	1.68	0.232	7.24	0.000	1.226	2.137
_cons	2.24	0.049	45.32	0.000	2.146	2.339
Motivational/Motivating Factor of Motivation (Latent factor: LF2)						
Var30_6 (Self-esteem)	<-					
	1	Constrained				
_cons	4.01	0.025	160.5	0.000	3.961	4.059
Var30_7 (Promo & growth)	<-					
	2.43	0.311	7.82	0.000	1.824	3.044
_cons	3.62	0.045	80.38	0.000	3.534	3.711
Var30_8 (Recognition)	<-					
	0.82	0.155	5.27	0.000	0.514	1.122
_cons	~4.0	0.023	176.1	0.000	3.941	4.029
Var30_9 (Advncmnt_actua)	<-					
	1.14	0.157	7.28	0.000	0.835	1.449
_cons	4.0	0.028	141.4	0.000	3.927	4.038
-----	----	----	----	---	----	----
var(e.Var30_1)	0.209	0.019			0.175	0.251
var(e.Var30_2)	0.335	0.025			0.289	0.389
var(e.Var30_3)	0.128	0.013			0.105	0.157
var(e.Var30_4)	0.417	0.036			0.353	0.494
var(e.Var30_5)	0.628	0.066			0.511	0.772
var(e.Var30_6)	0.149	0.021			0.112	0.197
var(e.Var30_7)	0.212	0.058			0.124	0.363
var(e.Var30_8)	0.137	0.016			0.109	0.171
cov(e.Var30_9)	0.185	0.018			0.153	0.224
var (Hygiene/ Maintenance; LF1)	0.124	0.022			0.086	0.176
var (Motivational; LF2)	0.101	0.023			0.064	0.159
-----	-----	-----	-----	---	-----	-----
cov(e.Var30_1,e.Var30_2)	0.086	0.017	5.04	0.000	0.053	0.119
cov(e.Var30_1,e.Var30_6)	-0.003	0.012	0.22	0.824	0.027	0.021
cov(e.Var30_2,e.Var30_3)	0.037	0.012	3.06	0.002	0.013	0.061
cov(e.Var30_2,e.Var30_4)	-0.012	0.021	-0.58	0.563	-0.053	0.027
cov(e.Var30_3,e.Var30_4)	0.053	0.017	3.21	0.001	0.021	0.086
cov(e.Var30_3,e.Var30_5)	-0.064	0.021	-2.96	0.003	-0.106	-0.021
cov(e.Var30_4,e.Var30_5)	-0.12	0.035	-3.31	0.001	-0.185	-0.047
cov(e.Var30_5,e.Var30_6)	-0.028	0.024	-1.14	0.254	-0.075	0.019
cov(e.Var30_6,e.Var30_7)	-0.091	0.029	-3.12	0.002	-0.147	-0.034

cov(e.Var30_6,e.Var30_9)	-0.018	0.015	-1.25	0.212	-0.047	0.010
cov(e.Var30_7,e.Var30_8)	-0.082	0.023	-3.50	0.000	-0.128	-0.036
cov(e.Var30_8,e.Var30_9)	0.001	0.013	0.030	0.976	-0.026	0.026
cov(Hygiene, Motivational)	0.080	0.014	5.83	0.000	0.053	0.107
Number of obs = 400; Esti. method = ml; Log likelihood = -2979.2854; LR test of model vs. saturated: chi2(14) = 40.31, Prob > chi2 = 0.0002						

The above measurement Table 5.60 gives information about how the model is specified by listing the observed variables mentioning with coefficient values of the two latent factors namely *Hygiene or Maintenance* ($\beta=0.124$) and *Motivating* ($\beta=0.101$). The coefficient values of the *maintenance latent* factor respectively are meeting basic need ($\beta=1$, constrained), job security ($\beta=0.62<1$), colleague or staff relationship ($\beta=0.73<1$), bank policy/HR policy and administration ($\beta=0.98$ near to 1), and employee participation ($\beta=1.68>1$). Correspondingly, the coefficient values of the motivating factors are self-esteem ($\beta=1$, constrained), promotion and growth ($\beta=2.43>1$), recognition and rewarding ($\beta=0.82<1$ or near to 1) and advancement through challenging performance ($\beta=1.14>1$). The p -values for all of the factor loadings are given below the typical cut-off of .05, leading to the rejection of the null hypotheses that the factor loadings are equal to 0; hence, the factor loadings are statistically weighty. Their degrees need to be inferred to assess their substantive significance. Researcher has got the standardized factor loadings because the variance for *hygiene* is set to 1 to measure the latent variable and for model identification. The standardized factor loading for the *employee participation* variable is 1.68 i.e., >1.00 meaning that a one standard deviation increased in *hygiene* leads to 1. The remaining all other factors are less effective factors in the model. Similarly, the standardized factor loadings because the variance for *motivating* was set to 1 to scale the latent variable and for model identification. The standardized factor loading for the *promotion and growth and advancement for challenging performance* are 2.43 and 1.14 i.e., >1 meaning that a one standard deviation increased leading to 1 and the strong effective factor. The test statistic value is highly significant (p -value= $0.000<0.05$) at 5% level of significance.

The model chi-square value, χ^2 $\chi^2(14) = 40.31$, Prob > $\chi^2 = 0.0002$, is extremely statistically significant indicating the model reproduces the observed covariance among all factors just fine. The p -value of $0.000 < 0.05$, the typical cut-off for the test, which means that the null hypothesis is rejected and the model fits well. With all of the model level fit measures taken together, the overall model fits extremely well meaning that the latent variable specified as *hygiene* and *motivating* are strongly

correlated to the all factors used to quantity it. The output also be responsible for with the χ^2 value of 40.31, with the degree of freedom 36, and the significance of the chi-square test (i.e. $p < 0.001$). Therefore, Employee satisfaction = f (Hygiene factor + Motivating factor).

Hypothesis: There is an effect of Duel Theory on employee satisfaction and motivation.

Table 5.61: Results of path coefficients of Dual Theory of motivation

Structural paths	Coef.	p-value	Remarks	Impact
Satisfaction<---Hygiene	0.124	0.000	H_{a1} ; supported	Directly related
Satisfaction<---Motivating	0.101	0.000	H_{a2} ; supported	Directly related
Satisfaction<---Hygiene, and Motivating	0.080	0.000	H_{a3} ;sustained	Directly related

The hypothesized/structural equation model (SEM) describes the study that there is a direct significant effect of Two-Factor/ Duel Theory on employee satisfaction in the sampled banks (Table 5.61).

5.6 Study Hypotheses of Employee Satisfaction

To investigate the effectiveness of employee the researcher assumed the following hypotheses:

H_{01} : JCM factors have no significant effect on employee satisfaction influencing motivation.

H_{02} : Hygiene benefits have no significant influence on the employee satisfaction.

H_{03} : Motivational benefits have no influence on the employee satisfaction.

5.6.1 Normality Check for Employee Satisfaction

Multiple linear regression models should follow normality assumptions to fit the dependent variable (ES). From the normality test table the Shapiro-Wilk test statistic value is 0.943~94% with p - value 0.000 (< 0.05). The fitted histogram plot shown that the bell shaped curve, similarly the normal Q-Q (Quantile-Quantile; Figure 5.9) plot shown that the fitted line approximately passing throw the origin. Therefore, it may conclude that the dependent variable *employee satisfaction* follow the normal distribution. In this regards, multiple regression model may use for further investigations.

Table 5.62: Normality test of dependent variable (employee satisfaction)

Dependent variable	Tests of Normality			Remarks
	Shapiro-Wilk			
	Statistic	df	Sig.	
Employee Satisfaction	0.943	400	0.000*	The normality test has been satisfied for fitting Employee Satisfaction as a dependent variable in the multiple regression model.
*Significant at 5% level.				

5.6.2 Charts for Employee Satisfaction and Its Normality Test

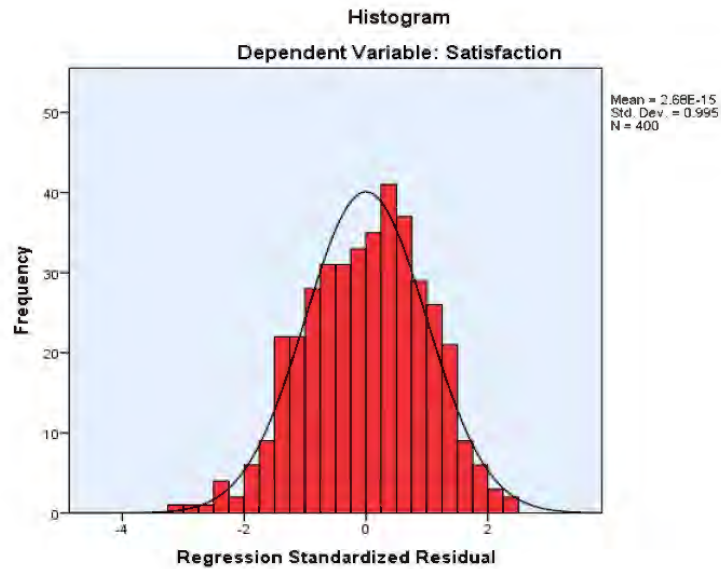

Figure 5.9: Fitted histogram for employee satisfaction

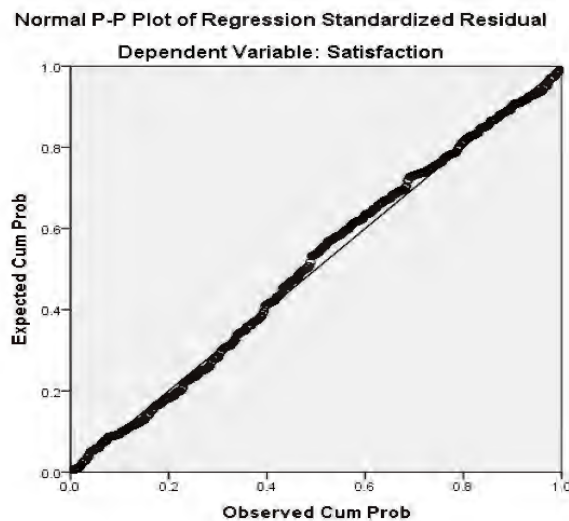

Figure 5.10: Q-Q plot for employee satisfaction

5.6.3 Dependent and Independent Variables

The employee satisfaction (ES) of the banking sector has been taken as dependent variable in the regression model. The regression model can be written as:

$$\text{Employee Satisfaction (ES)} = \alpha (\text{constant}) + \beta_1 * \text{JCM} + \beta_2 * \text{Hygiene} + \beta_3 * \text{Motivating} + e$$

From the above equation, α is constant, β_i 's are the regression coefficients of the explanatory variables, and e is the random error term (it follows normal distribution).

5.6.4 Investigation of Employee Satisfaction and HRD Model

Theoretical investigations have shown that dependent variable (ES) largely depends on independent variable (β_1 , β_2 and β_3). It is being observed that the banks are ready to provide the hygiene or maintenance and motivational factors for enhancing satisfaction among existing employees in the banks.

5.6.5 Multiple Linear Regression Model for Analysing Employee Satisfaction

Table 5.63: Coefficients^a of employee satisfaction

Factors of Employee Satisfaction	Estimated Coefficients		t-statistic	Sig.	95% Confidence Interval for β		F-Statistic (p -value)
	Regression Coefficient (β_i)	S.E			LB	UB	
Constant (α)	0.715	0.144	4.961	0.000	0.432	0.999	105.022 (0.000)
JCM (β_1)	0.083* (3)	0.033	2.537	0.012	0.019	0.148	
Hygiene (β_2)	0.315* (1)	0.036	8.760	0.000	0.244	0.385	
Motivating (β_3)	0.211* (2)	0.034	6.227	0.000	0.145	0.278	
a. Predictors: (Constant), Motivating, JCM, Hygiene Factors							
b. Dependent Variable: Employee Satisfaction							
*Significant at 5% level; R square ~67%; Durbin-Watson 1.680							

5.6.6 Results of Multiple Regression Analysis on Employee Satisfaction

The coefficient of multiple determinations R^2 is ~67% variability on the employee motivation has shown in the model. Similarly, the adjusted value of R^2 highlighted that 44.3% variability on the employee motivation can be explained by JCM, hygiene and motivational (independent variables). The Durbin test value is 1.680 (0 to <2.0) that are that there is positive autocorrelation between the variables.⁷ The F-Test value is 105.02 among the variables and p -values are less than 5% for the data variables indicates the very well fit of the regression model analysis. All the independent variables viz. *JCM, hygiene and motivational benefits* are statistically significant since p -value <0.05 and contributing the significant effect to the employee satisfaction (Table 5.63). Therefore, there is a significant effect on the employee satisfaction in the banking organization.

⁷ James Durbin, and Geoffrey S. Watson, "Testing for serial correlation in least squares regression.III", *Biometrika*, 1971, 58 (1): 1–19. doi:10.2307/2334313.

5.6.7 Fitted Regression Model for Employee Satisfaction

The fitted of the regression model as shown from the Table 5.63. It can be written as the fitted following regression model as equation form.

The fitted multiple regressions model can be written as:

$$ES = 0.715 * (\alpha) + 0.083 * JCM + 0.315 * Hygiene + 0.210 * Motivational Benefits$$

The β_1 , β_2 and β_3 coefficients findings are 8.3%, 31.5%, and 21% (t-statistic, 2.537, 8.760, and 6.227; p -values are 0.012, 0.000, and 0.000 respectively) times positively influence of JCM, hygiene and motivating facilities the employee motivation. The coefficients results are statistically significant p -values are less than 0.05 level of significant. Thus, H_{01} , H_{02} and H_{03} are rejected.

Therefore, it was being inferred that JCM, hygiene and motivating factors have significant effect on employee satisfaction influencing motivation among the banks' employees.

5.7 Discussion on Findings

It can be stated that employees are satisfied in terms of pay, recruitment and selection. On the other hand, it was observed that existing employees were moderately satisfied on the promotion and leaves policy and dissatisfied on participation. The satisfaction level of state-owned or nationalized or public banks is better than that of private banks. Besides, it can be re-valuated the career development, leave policy of the banks for maintaining the satisfaction level of employees. This is why; these three factors are the most effective factors influencing the level of satisfaction.

It has been found that the higher level employees are more satisfied than lower level employees regarding MPS. In the JCM practices the designation is highly correlated and most effective factors. Autonomy and feedback are the significant factors influenced the satisfaction. But gender is the less effective factor compared to JCM in the banking job design.

According to the latent factor in the Two-Factor Theory of motivation as given by Herzberg that it explored the high effective factors were as participation, promotion

and growth and challenging performance. This clarifies that banking organization has been practicing the theories of motivation.

Since banking operations is now a challenging issue this is why HR department or strategic unit of HRD can develop the nature of the job as well as enrichment for avoiding affective reactions from the existing employees. On the other hand, bank employees should consider the situation of the challenges to sustain in the competitive arena. The adoptive policies of the job responsibilities should be developed for existing employee satisfaction and motivation.

Since banking activities are now a challenging this is why the HRD department or HRD's strategic unit can develop the nature of work as well as enrich existing employees to provide feedback on performances. So, the situation of challenges should be considered to keep the bank employees competitive in the competitive field.

Positive attitude towards work is considered as job satisfaction. The main task of management is to determine whether the employees are satisfied or dissatisfied with the work. A person's job preferences depend largely on the combination of salary, promotion and other job-related components. Regular attendance of employees, increased productivity or responsibility, positive morale, harmonious relationship, sense of discipline is the behavior of a satisfied employee. Basically, job satisfaction can be determined by the difference between what employees want from work and what they actually get. They will be satisfied if there is a balance between their hopes and attainments.

Chapter Six

Employee Benefits and Motivation

Background

Employee benefit reflects the regular salaries or wages employees receiving numerous complementary (supplementary) rewards as part of the employment exchange. These complementary awards are brought up for employee benefits. Facilities and services have a significant impact on the attraction of skilled and qualified manpower for any organization. The number of interested applicants is higher in all the institutions which provide maximum benefits. This chapter is divided into three sections namely financial and other monetary benefits, job security (fringe benefits), and leave benefits. This chapter represents the study specific objective number 4 (four): *To investigate the influence of employee benefits on motivation*. To analyze the data descriptive as well as inferential statistics have been applied.

6.1 Pay and Money

It is true that money plays an important role in motivating employees. But this is not an obvious fact. Herzberg and his associates (1959)¹ proved that money is an incentive indicator which occupies sixth position in human needs. The higher order needs such as need for recognition, appraisal, power, status/ego/esteem etc., cannot be met by financial incentives only. These needs can be fulfilled by ensuring non-financial incentives or satisfying those needs. Job security, due time promotion, performance appraisal, rewards, job characteristics and other factors like skill variety, task identity, task significance, autonomy, job feedback, participation, fringe benefits, leaves in different categories, retirement facilities etc. are referred as non-financial incentives.^{2&3} In this case the sustainable motivation could be possible to adopt by the banking organization as well.

¹ F. Herzberg "Motivational Theory", Retrieved on 16.10.10 from http://www.envisionsoftware.com/articles/Herzberg_Motivational_Theory.html.

² Neeru Malhotra, Pawan Budhwar, and Peter Prowse, "Linking Rewards to Commitment: An Empirical Investigation of four UK Call Centres", *In International Journal of Human Resource Management*, Routledge: Taylor & Francis Group, 2007: 2095-2127.

³ Nancy H. Shanks, "Management and Motivation", *In Introduction to Healthcare Management*, 3rd edition (United States: Jones & Bartlett Learning 2007): 2098.

6.2 Financial and Other Monetary Benefits

Employees are motivated by receiving intrinsic and extrinsic rewards from their services. Incentives create motivation which persuades individual outcomes. Incentives may be classified into two categories: (i) Financial and (ii) Non-financial incentives. (i) Financial incentives: Money or salary is regarded as one number of financial incentives.⁴ This is why; Taylor regarded people as an “economic man”. The other social scientists in human relations are considered people as “social being” or viewed money as an insignificant incentive factor.⁵ They thought that money has no role directly in motivating. But employees do have exchange money in lieu of getting some items or basic needs. Not only things but social status, power, influence, etc. also depend on financial benefits.

The main focus of this chapter has been discussed below:

6.3 Financial and Other Monetary Benefits

6.3.1 Statistical Analysis on Financial and Other Monetary Benefits

Descriptive and inferential analysis on the factors related to financial and other monetary incentives.

Table 6.1: Handsome salary influences motivation

Perception	Freq.	%	Remarks
Some extent	1	0.3	From Table 6.1 it is being noticed that 72.3% (majority) of the respondents believe that the handsome salary influences motivation.
Moderately extent	86	21.5	
Extent	289	72.3	
Highly extent	24	6.0	
Total	400	100.0	

Table 6.2: Profit sharing can motivate the employees

Perception	Freq.	%	Remarks
Not at all	4	1.0	From the Table 6.2 researcher has got that 59.3% (highest) of the employees believe that profit sharing is one of the indicators of satisfaction.
Some extent	12	3.0	
Moderately extent	99	24.8	
Extent	237	59.3	
Highly extent	48	12.0	
Total	400	100.0	

⁴ Frederick Winslow Taylor, *The Principles of Scientific Management* (New York: Harper, 1911).

⁵ F. J. Roethlisberger, and William J. Dickson, “Management and the Worker (Cambridge, Mass: Harvard University Press (Oxford University Press, 1939) *The Economic Journal*, Vol. xxiv+615. 26s. 6d.

Table 6.3: Bonus has positive impact on motivation

Perception	Freq.	%	Remarks
Moderately extent	83	20.8	Table 6.3 showed that 63.3% (maximum) of the respondents acknowledged that bonus does have positive impact on motivation in the banking sector.
Extent	253	63.3	
Highly extent	64	16.0	
Total	400	100.0	

Table 6.4: Loan facilities give higher output

Perception	Freq.	%	Remarks
Some extent	6	1.5	Table 6.4 depicted that 52.3% (highest, extent level)) of the participants feel that sanctioned loan increase output.
Moderately extent	53	13.3	
Extent	209	52.3	
Highly extent	132	33.0	
Total	400	100.0	

Table 6.5: Insurance facilities creating employee satisfaction

Perception	Freq.	%	Remarks
Not at all	3	0.8	Table 6.5 stated that majority (47%) of the respondents believe that employees satisfaction depends on insurance facilities.
Some extent	140	35.0	
Moderately extent	188	47.0	
Extent	60	15.0	
Highly extent	9	2.3	
Total	400	100.0	

Table 6.6: Transportation facilities increasing satisfaction

Perception	Freq.	%	Remarks
Not at all	24	6.0	Table 6.6 shows that 54% of the employees receiving transportation facilities is not satisfactory level due to < moderate level). Many of the branches did not give transportation facility for employees.
Some extent	216	54.0	
Moderately extent	110	27.5	
Extent	46	11.5	
Highly extent	4	1.0	
Total	400	100.0	

Table 6.7: Salary deduction decreasing satisfaction

Perception	Freq.	%	Remarks
Some extent	1	0.3	Table 6.7 stated that 66.8% (majority) of the respondents being perceived that salary deduction increases dissatisfaction among the existing employees.
Moderately extent	84	21.0	
Extent	267	66.8	
Highly extent	48	12.0	
Total	400	100.0	

Table 6.8: Stopped increment impediment in satisfaction

Perception	Freq.	%	Remarks
Some extent	1	0.3	From Table 6.8 researcher has found that 66% (highest) of the participants gave priority creating dissatisfaction from stopped increment.
Moderately extent	76	19.0	
Extent	264	66.0	
Highly extent	59	14.8	
Total	400	100.0	

Table 6.9: Stopped profit sharing barriers to satisfaction

Perception	Freq.	%	Remarks
Not at all	1	0.3	From the Table 6.9 it is being evident that 64.3% (extreme) of the participants provided extent level of dissatisfaction for stopped profit sharing.
Moderately extent	75	18.8	
Extent	257	64.3	
Highly extent	67	16.8	
Total	400	100.0	

6.3.2 Score Matrix of Financial and Other Monetary Benefits

Here, this section has shown observation on the level of employee motivation and its score regarding financial and other monetary benefits provided by the banks with short scored from the frequency distribution.

Table 6.10: Scoring of high, moderate and low motivation and satisfaction (>median, or 50%)

Fin & non-financial	High	Moderate	Low	Observation on level of satisfaction
Handsome salary	78.3%	21.5%	0.3%	It was observed that existing salary, profit sharing, bonuses and loan facilities are satisfying employees. These financial facilities show the high level of satisfaction.
Profit sharing	71.3%	24.8%	4%	
Bonus	79.3%	20.8%	0%	
Loan facilities	85.3%	13.3%	1.5%	
Insurance facilities	17.3%	47%	38.5%	
Transportation*	12.3%	27.5%	60%	*Lower level of satisfaction found in case of insurance and transportation facilities.
Salary deduction	78.8%	21%	0.3%	Salary deduction, stopped increment and postponed profit sharing certainly increase employee dissatisfaction in the banks.
Stopped increment	80.8%	19%	0.3%	
Stopped profit sharing	81.1%	18.8%	0.3%	

6.3.3 Bivariate Association of Employee Benefits

The factors included in the financial and other monetary benefits that influence employee motivation. This section has discussed among the variables. Chi-square test, Fisher's exact p -value as well as Pearson Correlation have been used to show the relationship and association.

Table 6.11: Bivariate correlation of financial benefits by crosstabs of bank type

Financial & non-financial benefits	Public Bank	Private Bank	χ^2 -Test statistic, Fisher's Exact p -value (sig.< p -value) and Pearson correlation (r =value)
Handsome salary influences motivation			
Some extent	1(0.31%)	0(0%)	It is being observed that $p=0.031<0.05$. Alternative hypothesis (H_a) accepted. There is a relationship between salary and motivation.
Moderately extent	59 (18.44%)	27 (33.75%)	
Extent	241 (75.31%)	48 (60%)	
Highly extent	19 (5.94%)	5 (6.25%)	
Profit sharing can motivate the employees			
Not at all	4 (1.25%)	0	Since $p=0.163>0.05$ and $r=0.445^{**}$. H_a is not sustained. Profit sharing insignificantly influences employee motivation.
Some extent	11 (3.44%)	1 (1.25%)	
Moderately extent	74 (23.13%)	15 (18.75%)	
Extent	189 (59.1%)	48 (60%)	
Highly extent	42 (13.13%)	6 (7.5%)	

Bonus has positive impact on motivation			
Moderately extent	58 (18.13%)	25 (31.25%)	Since $p=0.012<0.05$ and $r=0.448^{**}$ (highest). H_a is supported. Bonus significantly affects employee motivation.
Extent	205 (64.1%)	48 (60%)	
Highly extent	57 (17.81%)	7 (8.75%)	
Loan facilities give higher output			
Some extent	2 (0.63%)	4 (5%)	Got p -value $0.000<0.05$, and $r=0.361^{**}$. H_a failed to reject. There is a positive relationship in case of loan facilities in the banks.
Moderately extent	28 (8.75%)	25 (31.25%)	
Extent	165 (51.56%)	44 (55%)	
Highly extent	125 (39.1%)	7 (8.75%)	
Insurance facilities creating employee satisfaction			
Not at all	2 (0.63%)	1 (1.25%)	Since $p=0.004<0.05$, and $r=0.371^{**}$. H_a is accepted. This is why; significantly insurance facilities create satisfaction.
Some extent	110 (34.4%)	30 (37.5%)	
Moderately extent	163 (50.94%)	25 (31.25%)	
Extent	38 (11.88%)	22 (27.5%)	
Highly extent	7 (2.19%)	2 (2.5%)	
Transportation facilities increasing satisfaction			
Not at all	17 (5.31%)	7 (8.75%)	Got $p=0.026<0.05$, and $r=0.323^{**}$. H_a is confirmed. It is being observed that transportation facilities confirm satisfaction among existing employees in the banks.
Some extent	182 (56.88%)	34 (42.5%)	
Moderately extent	89 (18.44%)	21 (26.25%)	
Extent	30 (9.38%)	16 (20%)	
Highly extent	2 (0.63%)	2 (2.5%)	
Salary deduction decreasing satisfaction			
Some extent	1 (0.33%)	0	Here, it is found $p=0.171>0.05$, and $r=0.298^{**}$. Salary deduction and employee satisfaction insignificantly influence motivation.
Moderately extent	60 (18.75%)	24 (30%)	
Extent	220 (68.75%)	47 (58.75%)	
Highly extent	49 (15.31%)	9 (11.25%)	
Stopped increment creating dissatisfaction			
Some extent	1 (0.33%)	0	Due to $p=0.268>0.05$, and $r=0.192^{**}$. H_a is not accepted. There is a negative relationship between postponed increment and dissatisfaction.
Moderately extent	58 (18.13%)	18 (22.5%)	
Extent	209 (65.31%)	55 (68.75%)	
Highly extent	52 (16.25%)	7 (8.75%)	
Stopped profit sharing increases dissatisfaction			
Not at all	1 (0.33%)	0	It is resulted that, $p=0.031<0.05$, and $r=0.202^{**}$. It is confirming that profit sharing increases satisfaction.
Moderately extent	51 (15.94%)	24 (30%)	
Extent	210 (65.63%)	47 (58.75%)	
Highly extent	58 (18.13%)	9 (11.25%)	

NB. Public Bank means Nationalized or State-owned Banks,

6.3.4 Exploratory Factor Analysis for Financial and Other Monetary Benefits

Table 6.12: Descriptive and test results for EFA of financial and other monetary benefits

Financial benefits and other monetary benefits	Mean	SD	Test result
Handsome salary influences (Handsome salary)	3.84	0.51	KMO=0.83 $\chi^2= 933.533$ df.= 36 p -value= 0.000 N=400 Extraction: PCA Data are excellent fit for EFA
Profit sharing can motivate (Profit sharing)	3.78	0.73	
Bonus has positive impact (Bonus)	3.95	0.61	
Loan facilities give higher output (Loan facilities)	4.17	0.70	
Insurance facilities influence satisfaction (Insurance)	2.83	0.77	
Transportation increases satisfaction (Transportation)	2.48	0.81	
Salary deduction decreases satisfaction (Salary deduction)	3.91	0.58	
Stopped increment creates dissatisfaction (Stopped increment)	3.95	0.59	
Stopped profit sharing affects satisfaction (Stopped profit sharing)	3.97	0.62	

Table 6.12: shows that the minimum mean value (2.48 and 2.83) of transportation and insurance facilities. It was being observed that loan facility has been entertained with the existing employees. The other factors are moderately good (mean values near to 4 scale).

Table 6.13: EFA and total variance explained for financial and other monetary benefits

Communalities: Financial and Other Monetary Benefits			Total Variance Explained				Remarks on loadings
			Initial (1.00) Eigenvalues		Extraction Sums of Squared Loadings		
Components	Initial	Extraction	Total	% of Variance	Total (>1)	% of Variance	
1. Bonus	1.00	0.714	3.51	39.050	3.514	39.05	Loaded by 64%
2. Insurance	1.00	0.711	1.17	13.003	1.170	13.00	
3. Transportation	1.00	0.705	1.10	12.256	1.103	12.26	
4. Stopped increment	1.00	0.680	0.72	7.967	-	-	-
5. Loan facilities	1.00	0.666	0.61	6.811	-	-	-
6. Stopped profit_share	1.00	0.635	0.55	6.153	-	-	-
7. Profit sharing	1.00	0.624	0.49	5.460	-	-	-
8. Handsome salary	1.00	0.560	0.46	5.091	-	-	-
9. Salary deduction	1.00	0.492	0.38	4.210	-	-	-
Values of all components extraction are >0.40 ⁶ . Total variance explained and loaded covering (1+2+3) 64.31% .							

Table 6.13 shows that extraction values of three components are more than 40% the communality from 1 to 3 out of nine factors. There are three factors with Eigenvalues (bonus, insurance and transportation 1.248) more than 1.00. That means, these three components are highly loaded and covered 64% (39.05 + 13.00 + 12.26) of the total variance explained as Eigenvalues for employee motivation. Employees want to get the three components. Banking sector should review these three factors.

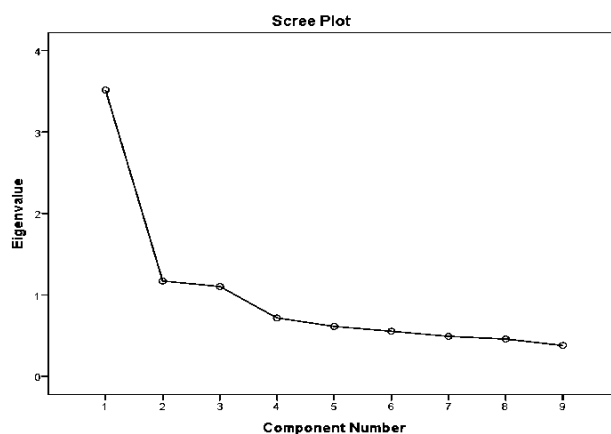

Figure 6.1: Scree plot of financial & non-financial benefits

Figure 6.1 shows the scree plot of Eigenvalues and depicting two factors are constructing elbow-shaped and maximum proportion variance is explained in the graph. The top three communalities have been extracted i.e., impact of bonus, insurance and transportation facilities are significant in the study.

⁶ Ajai S. Gaur and Sanjaya S. Gaur, *Statistical Methods for Practice and Research*, 2nd edn (New Delhi: Response Books, 2009):143.

6.3.5 Measuring Effective Factors of Financial and Other Monetary Benefits through SEM

This section confirmed the effective factors of financial and other monetary facilities for which existing employees may inspire to perform. SEM explores the most effective factors through the latent factors.

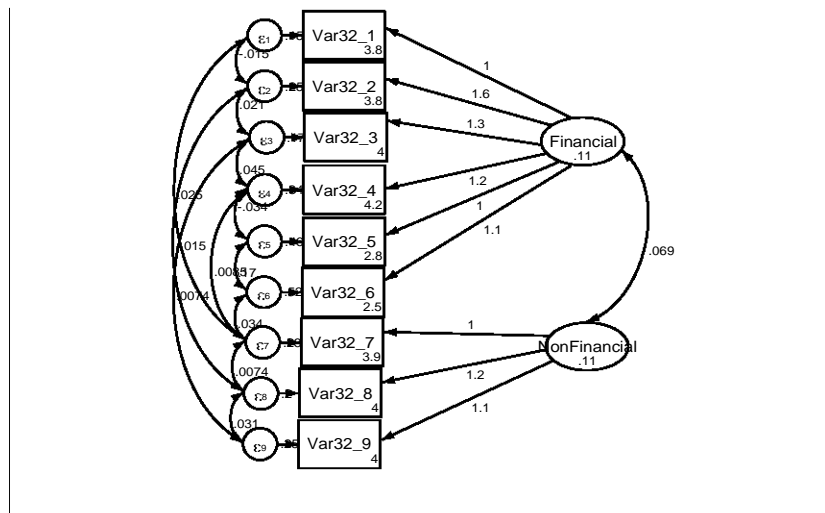

Figure 6.2: SEM path of financial & other monetary benefits

Figure 6.2 SEM depicts the two latent factors of the constructed variables. It is being remarking that the financial (LF1; coef. values is 0.11) and *Other Monetary* benefits (LF2; estimated coefficien. value is 0.11) along with overall estimated result 0.069. All the mean values of all factors are also provided by the figure.

Table 6.14: Measurement for SEM: Financial and other monetary benefits

Factors (Measurement)	Coef.	S.E	z	p>z	95% Conf. Interval	
Financial Benefits (Latent variable: LF1)						
Var32_1(Handsome salary)	<-					
	1	(constrained)				
_cons	3.84	0.026	150.6	0.000	3.790	3.900
Var32_2(Profit sharing)	<-					
	1.579	0.170	9.3	0.000	1.246	1.911
_cons	3.783	0.037	103.76	0.000	3.711	3.854
Var32_3(Bonus impact)	<-					
	1.330	0.147	9.04	0.000	1.042	1.618
_cons	3.953	0.030	130.64	0.000	3.893	4.012
Var32_4 (Loan facilities)	<-					
	1.153	0.145	7.94	0.000	0.869	1.438
_cons	4.168	0.035	118.39	0.000	4.099	4.236
Var32_5 (Insurance)	<-					
	1.043	0.141	7.38	0.000	0.766	1.320
_cons	2.83	0.039	73.53	0.000	2.755	2.905
Var32_6(Transportation)	<-					
	1.119	0.154	7.26	0.000	0.817	1.421
_cons	2.475	0.041	60.88	0.000	2.395	2.555

Other Monetary Benefits (Latent variable: LF2)						
Var32_7 (Salary deduction)	<-					
	1	(constrained)				
_cons	3.905	0.029	135.58	0.000	3.849	3.962
Var32_8 (<i>Stopped increment</i>)	<-					
	1.162	0.180	6.47	0.000	0.810	1.514
_cons	3.953	0.029	134.37	0.000	3.895	4.010
Var32_9(Stopped profit)	<-					
	1.078	0.200	5.38	0.000	0.685	1.470
_cons	3.973	0.031	129.28	0.000	3.912	4.033
<i>var(Financial; LF1)</i>	0.113	0.019			0.081	0.158
<i>var(Other Monetary; LF2)</i>	0.106	0.028			0.064	0.178
<i>Cov(Financial Other Monetary)</i>	0.069	0.014	5.01	0.000	0.042	0.096
var(e.Var32_1)	0.147	0.015			0.120	0.179
var(e.Var32_2)	0.248	0.044			0.176	0.353
var(e.Var32_3)	0.165	0.020			0.130	0.210
var(e.Var32_4)	0.344	0.033			0.286	0.414
var(e.Var32_5)	0.464	0.038			0.396	0.545
var(e.Var32_6)	0.517	0.039			0.446	0.600
var(e.Var32_7)	0.225	0.032			0.171	0.298
var(e.Var32_8)	0.202	0.037			0.140	0.291
var(e.Var32_9)	0.253	0.036			0.192	0.334
cov(e.Var32_2,e.Var32_1)	-0.015	0.017	-0.9	0.37	-0.047	0.018
cov(e.Var32_7,e.Var32_1)	0.026	0.012	2.15	0.032	0.002	0.049
cov(e.Var32_3,e.Var32_2)	0.021	0.020	1.09	0.276	-0.017	0.060
cov(e.Var32_8,e.Var32_2)	-0.016	0.016	-0.95	0.342	-0.047	0.017
cov(e.Var32_4,e.Var32_3)	0.045	0.017	2.65	0.008	0.012	0.079
cov(e.Var32_9,e.Var32_3)	0.007	0.013	0.58	0.561	-0.018	0.032
cov(e.Var32_5,e.Var32_4)	-0.035	0.020	-1.69	0.091	-0.074	0.006
cov(e.Var32_7,e.Var32_4)	0.009	0.016	0.55	0.585	-0.022	0.039
cov(e.Var32_6,e.Var32_5)	0.170	0.030	5.6	0	0.110	0.229
cov(e.Var32_7,e.Var32_6)	0.034	0.018	1.86	0.063	-0.002	0.070
cov(e.Var32_8,e.Var32_7)	0.007	0.024	0.32	0.753	-0.039	0.053
cov(e.Var32_9,e.Var32_8)	0.031	0.026	1.19	0.234	-0.020	0.081
Log likelihood = -2551.95; LR test: independent vs. saturated: chi2(36) = 935.90 Prob>chi2 = 0.0000						

This Table 6.14 gives information about how the model is specified by listing the observed variables mentioning with coefficient values of the latent factor (LF1) *Financial Facilities* ($\beta=0.11$) are handsome salary ($\beta=1$, constrained), profit sharing ($\beta=1.579>1$), bonus ($\beta=1.330>1$), loan facilities ($\beta=1.153>1$), insurance ($\beta=1.043>1$), transportation ($\beta=1.119>1$). Similarly, the table shows information on how the model is specified by listing the observed variables are salary deduction ($\beta=1$, constrained), stopped increment ($\beta=1.162>1$), stopped profit sharing ($\beta=1.078>1$) and the latent variable (LF2) *Other Monetary Benefits* ($\beta=0.11$).

The study has got the standardized factor loadings because of the variance for *financial benefits* have been set to 1 to scale the latent variable and for model identification. The standardized factor loading for the *profit sharing* variable is 1.579, (>1.00) meaning that a one standard deviation increased in *financial benefits* leads to a 1.579 standard

deviation increased in the response to the *profit sharing* in the model. The remaining all other factors are the strongest factor loading of the latent factor *financial benefits* since the coefficient values are greater than 1 (coef. values > 1); therefore, it is the best measure of *Financial Benefits*. Similarly, the standardized factor loadings because the variance for *Other Monetary Benefits* has been set to 1 to measure the latent variable and for model identification. The standardized factor loading for the *stopped increment* variable is 1.162, meaning that a one standard deviation increased in *stopped increment* leads to 1.162 standard deviation increases in the response to the *non-financial* in the model. The test statistic value highly significant ($p\text{-value}=0.000 < 0.05$) at 5% level of significance. The model chi-square value, $\chi^2(36) = 935.90$, $\text{Prob} > \chi^2 = 0.000$, is highly statistically significant indicating the model reproduces the observed co-variance among all factors very well. Null hypothesis fits in this case. The $p\text{-value}$ of 0.000 is less than .05, the typical cut-off for the test, which means that the null hypothesis is rejected and the model fits well. With all of the levels of model fit measures taken together, the overall model fits extremely well meaning that the latent variable specified as *Financial Benefits* and *Other Monetary Benefits* are strongly related to the all factors used to quantify it. The output also provides with the chi-square value of 935.90, with the degree of freedom 36, and the significance of the chi-square test (i.e. $p < 0.001$). Therefore, Employee Motivation = f (Financial Benefits + Other Monetary Benefits).

Hypothesis: There is an effect of financial and non-financial benefits of employee motivation.

Table 6.15: Results of path coefficients of financial and other monetary benefits

Hypothesized Structural Path	$p\text{-value}$	Coef.	Results	Relationship
Motivation <- Financial Benefits	0.000	0.110	H_{a1} ; supported	Direct effect
Motivation <- Other Monetary Benefits	0.000	0.110	H_{a2} ; supported	Direct effect
Motivation <- Financial & Other Monetary Benefits	0.000	0.220	H_{a3} ; supported	Direct effect

Therefore, it was observed that all null hypotheses are rejected and alternative hypotheses are supported this is why there is a strong effect of financial and other monetary benefits on employee motivation of the sampled banks (Table 6.15).

6.4 Job Security (Fringe Benefits) and Employee Motivation

Fringe benefits are the additional benefits paid to an employee above the salary specified for performing a particular service. Benefit of certain limitation such as social

security has been considered. The first is social and health insurance required by law such as medical, accidental, GPF, CPF, family benefits after retirement (FBAR) etc. In this section the factors of fringe benefits covering the job security in the banks.

6.4.1 Statistical Analysis on Fringe (Job Security) Benefits in the Sampled Banks

Table 6.16: GPF (General pension fund)

Perception	Freq.	%	Remarks
Never	221	55.3	Table 6.16 showed that 55.3% (majority) of the employees did not receive GPF. 43.3% of entertained by GPF facilities.
Very Often	6	1.5	
Always	173	43.3	
Total	400	100.0	

Table 6.17: CPF (Contributory provident fund)

Perception	Freq.	%	Remarks
Never	173	43.3	Table 6.17 explained that 50.3% (majority) of the employees received CPF. Both public and private banks ensured CPF.
Sometimes	4	1.0	
Very often	22	5.5	
Always	201	50.3	
Total	400	100.0	

Table 6.18: Medical benefits (MB)

Perception	Freq.	%	Remarks
Never	1	0.3	Table 6.18 showed that majority of respondents (52.8% and 46.3%; very often and always) receiving medical benefits.
Sometimes	3	0.8	
Very often	211	52.8	
Always	185	46.3	
Total	400	100.0	

Table 6.19: Accidental death benefits (ADB)

Perception	Freq.	%	Remarks
Never	103	25.8	From the Table 6.19 researcher has found that 48% of the employees receiving accidental benefits (sometimes). About 26% of the employees do not get accidental benefits. This facility varied in terms of employment status.
Sometimes	192	48.0	
Often	74	18.5	
Very often	22	5.5	
Always	9	2.3	
Total	400	100.0	

Table 6.20: Child education allowances (CEA)

Perception	Freq.	%	Remarks
Never	73	18.3	The study (Table 6.20) being found that 45% of participants got child education allowances. It has also found that only public bank gives child education allowances.
Sometimes	9	2.3	
Often	4	1.0	
Very often	180	45.0	
Always	134	33.5	
Total	400	100.0	

Table 6.21: Family benefits after retirement (FBAR)

Perception	Freq.	%	Remarks
Never	206	51.5	Table 6.21 depicted that 51.5% (highest) of the employees do not get family benefits after retirement. Private bank does not entertain this facility because it is related to GPF.
Sometimes	8	2.0	
Often	4	1.0	
Very often	32	8.0	
Always	150	37.5	
Total	400	100.0	

6.4.2 Score Matrix of Fringe Benefits Reflecting Job Satisfaction and Motivation

This section has shown the investigations on the level of satisfaction regarding fringe benefits or job security (JS) entertained by the banks. The score is developed from the frequency distribution perceived by the existing employees on job security related factors (Table 6.22).

Table 6.22: Score of high and low motivation level on FB/JS (>median=200 or 50%)

FB	High	Moderate	Low	Observation on level of satisfaction
GPF	179 (44.8%)	0	221 (55.33%)	Inconsistent between GPF and CPF in terms of public and private banks.
CPF	223 (55.8%)	0	177 (44.3%)	
MB	396 (99%)	4 (1.1%)	0%	Majority employees are receiving MB.
ADB	31 (7.8%)	74 (18.5%)	295 (74%)	Dissatisfaction exists on accidental case.
CEA	314 (78.5%)	4 (1%)	81 (20.6%)	Public banks providing CEA.
FBAR	182 (45.5%)	4 (1%)	214 (54%)	Dissatisfaction presents on FBAR.

The above analysis (Table 6.16 to 6.22) shows the results that employees of public banks are entertaining the GPF and CPF facilities covering the accidental and retirement benefits. But in the private it is observed that employees can receive the CPF facility only. That's why; facilities provided involved in the fringe or job security show a significant difference between nationalized or public and private banks.

6.4.3 Bivariate Analysis of Fringe Benefits for Employees' Job Security

Researcher has developed the Bivariate and Correlation Matrix based on the elements of fringe benefits perceived by the employees in the banks. In this part it has been noticed the impact of FBs on motivation through using the Chi-square test and Fisher's Exact *p*-value (Table 6.23). Family benefits after retirement (FBAR) shows the highest correlation and significant impact of employee motivation ($r=0.959$).

Table 6.23: Matrix for bivariate analysis on fringe benefits (FBs) and motivation

FBs & Scale (%)	Pearson Correlation, Chi ² test of Fisher's Exact <i>p</i> -value	
	$\alpha=0.01$ ** $\alpha=0.05$ * (2-tailed)	Effect of FBs on Employee Motivation
GPF (44.8%)	$r=1$ (cons); perfect correlation p -value $0.000 < \alpha$; H_{01} rejected	GPF is significantly related to employee motivation.
CPF (55.8%)	$r = (-0.976)$ ** p -value $0.000 < \alpha$; H_{02} rejected	There is significant relationship between CPF and motivation.
MB (99%)	$r=0.222$ ** p -value $0.000 < \alpha$; H_{03} rejected	Medical allowances influence motivation significantly.
ADB (7.8%)	$r=0.192$ ** p -value $0.000 < \alpha$; H_{04} rejected	Accidental death benefits strongly influence motivation.
CEA (78.5%)	$r=0.481$ ** p -value $0.000 < \alpha$; H_{05} rejected	Child education allowance confirms influence motivation.
FBAR (45.5%)	$r=0.959$ ** (highest) p -value $0.000 < \alpha$; H_{06} rejected	It is evident that family benefits after retirement strongly influence motivation.
Source: Matrix Table compiled from primary data output by researcher		

6.4.4 Factor Analysis of Fringe Benefits

Table 6.24: Descriptive and EFA for fringe benefits (Job security)

Fringe benefits (Job Security)	Mean	SD	Test result
General Pension Fund (GPF)	2.775	1.978	KMO=0.785 $\chi^2=2407.991$ df.=15 Sig.=0.000 N=400 EM=PCA
Contributory Provident Fund (CPF)	3.185	1.944	
Medical benefits (MB)	4.440	0.568	
Accidental death benefits (ADB)	2.105	0.925	
Child education allowances (CEA)	3.733	1.418	
Family benefits after retirement (FBAR)	2.780	1.903	
Extraction: Principal Component Analysis (PCA); Remarks: Data are statistically significant and excellent fit for EFA.			

Table 6.24: shows that the mean value (4.440>4.0) of medical facility which has represented maximum of very often. Lower mean values of GPF, accidental benefits and family benefits after retirement are 2.775, 2.105 and 2.780 respectively which are less than 3 meaning that little true. Private bank does not entertain the GPF and child education allowances.

Table 6.25: EFA and total variance explained for fringe benefits (Job security)

Communalities: Fringe Benefits/Job Security			Total Variance Explained				Remarks on loadings
			Initial (1.00) Eigenvalues		Extraction Sums of Squared Loadings		
Components	Initial	Extraction	Total	% of Variance	Total (>1)	% of Variance	
1. GPF	1.000	0.956	3.327	55.445	3.327	55.445	Loaded by 74%
2. FBAR	1.000	0.938	1.095	18.243	1.095	18.243	
3. CPF	1.000	0.932	0.905	15.086	-	-	-
4. ADB	1.000	0.690	0.596	9.933	-	-	-
5. CEA	1.000	0.593	0.057	0.953	-	-	-
6. MB	1.000	0.312	0.020	0.340	-	-	-
*Extraction is <0.40. Total variance explained and loaded covering (1+2) ~74%.							

Table 6.25 shows that extraction values of five components are more than 40% the communality from 1 to 5 out of the nine factors. There are two factors with Eigenvalues (GPF and family benefits after retirement: 3.327 and 1.095) more than 1.00. That means, these two components are highly loaded and covered 74% (55.445 +18.243) of the total variance explained as Eigenvalues for employee motivation. Employees desire to get GPF results family benefits after retirement. It has been observed that both public (since 2008) and private bank offer CPF. These two components are most significant for employee motivation. Banking sector should reevaluate these three factors.

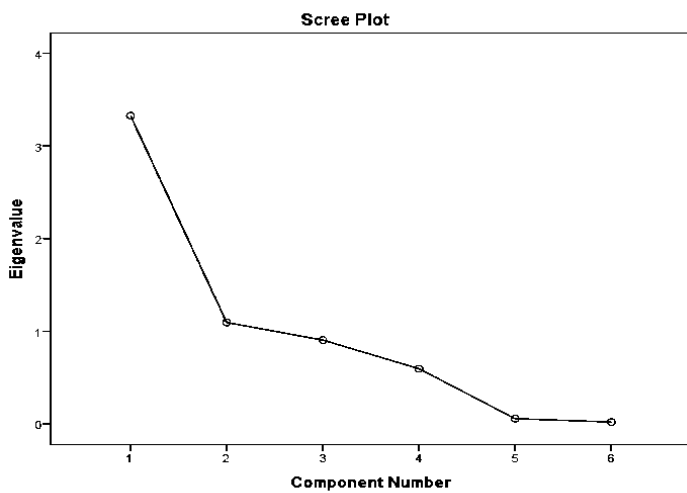

Figure 6.2 shows the scree plot of Eigenvalues and depicting two factors are forming elbow-shaped and maximum proportion variance is explained in the graph. The top two communalities have been extracted i.e., *GPF* and *family benefit after retirement* (FBAR) are most significant.

Figure 6.3: Scree plot of fringe benefits (Job security)

6.4.5 Measuring the Effective Factors of Fringe Benefits through SEM

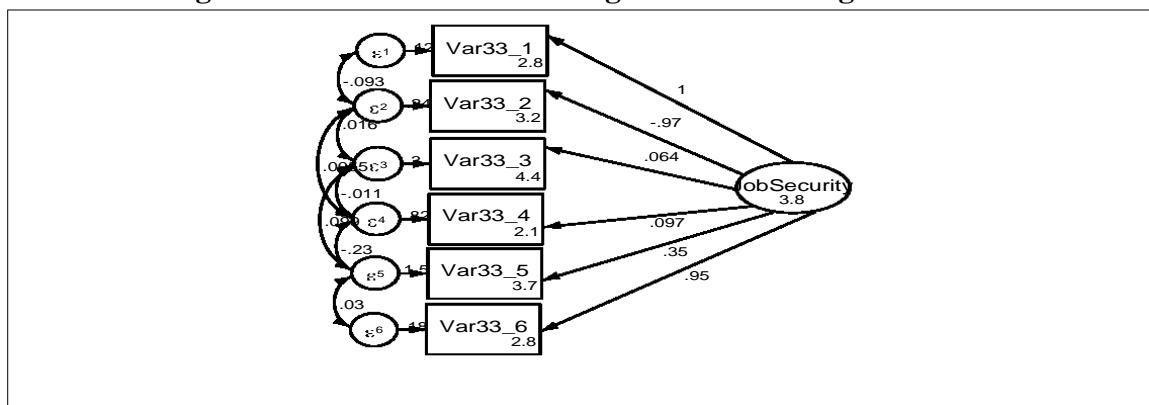

Figure 6.4: SEM of job security (Fringe benefits)

Figure 6.4 shows the latent factor (LF) of the SEM constructs. The estimated coefficient value of the LF is 3.78 explaining mean values (33.1 to 33.6) of all variables shown in the figure.

Table 6.26: Measurement for SEM of job security

Factors (Measurement)	Coef.	Std. Err.	z	p>z	95% Conf. Interval	
Job Security (Latent factor)						
Var33_1(GPF)	<-					
	1	(constrained)				
_cons	2.775	0.099	28.05	0.000	2.581	2.969
Var33_2 (CPF)	<-					
	-0.966	0.012	-82.65	0.000	-0.989	-0.943
_cons	3.185	0.097	32.76	0.000	2.995	3.376
Var33_3(Medical)	<-					
	0.064	0.015	4.4	0.000	0.035	0.092
_cons	4.44	0.028	156.44	0.000	4.385	4.496
Var33_4 (Accidental)	<-					
	0.097	0.028	3.5	0.000	0.043	0.152
_cons	2.105	0.046	45.5	0.000	2.014	2.196
Var33_5 (Child edu)	<-					
	0.350	0.037	9.53	0.000	0.280	0.422
_cons	3.733	0.071	52.64	0.000	3.594	3.872
Var33_6 (Family benefits)	<-					
	0.953	0.071	13.38	0.000	0.813	1.093
_cons	2.78	0.095	29.22	0.000	2.594	2.967
var(Job security)	3.781	0.272			3.284	4.353
var(e.Var33_1)	0.123	0.269			0.002	8.899
var(e.Var33_2)	0.241	0.272			0.026	2.202
var(e.Var33_3)	0.305	0.037			0.241	0.387
var(e.Var33_4)	0.819	0.072			0.690	0.972
var(e.Var33_5)	1.546	0.105			1.353	1.767
var(e.Var33_6)	0.178	0.279			0.008	3.847
cov(e.Var33_2,e.Var33_1)	-0.093	0.272	-0.34	0.733	-0.626	0.441
cov(e.Var33_3,e.Var33_2)	0.016	0.017	0.92	0.359	-0.018	0.050
cov(e.Var33_4,e.Var33_2)	0.006	0.020	0.27	0.786	-0.034	0.045
cov(e.Var33_4,e.Var33_3)	-0.011	0.030	-0.36	0.717	-0.070	0.048
cov(e.Var33_5,e.Var33_3)	0.099	0.036	2.72	0.007	0.028	0.170
cov(e.Var33_5,e.Var33_4)	-0.227	0.060	-3.81	0	-0.344	-0.111
cov(e.Var33_6,e.Var33_5)	0.030	0.096	0.31	0.759	-0.160	0.218
LR test: independent vs. saturated: $\chi^2(36) = 935.90$ Prob> $\chi^2 = 0.0000$						

The Table 6.26 shows information on how the SEM is specified by listing the observed variables with coefficient values of the latent variable *job security* ($\beta=3.781\sim 3.80$) are GPF ($\beta=1$, constrained), CPF ($\beta=-0.966$), medical ($\beta=0.064$), accidental benefits ($\beta=0.097$), child education allowance ($\beta=0.350$), and family benefits after retirement ($\beta=0.953$). All these factors' coefficient values are <1 . But it being observed that family benefits after retirement is the most effective factor. Researcher has found the standardized factor loadings because the variance for *job security* being set to 1 to measure the latent variable and for model identification. The standardized factor loading all factors are the less effective and significant factors as because the coefficient values are less than 1. Among these family benefits after retirement ($\beta=0.953$) is the strongest factor.

The model chi-square value, $\chi^2(36) = 935.90$ Prob>chi² = 0.0000, is highly statistically significant (p -value <0.05) indicating the model reproduces the observed covariance among all factors very well. The null hypothesis is that the model fits perfectly. The p -value of 0.000 is less than .05, the typical cut-off for the test, which means that the null hypothesis is rejected and the model turns well. The overall model fits extremely well meaning that the latent variable specified as *job security is* strongly associated to the all factors applied to measure it. The output also provides with the chi-square value of **935.90**, with the degree of freedom 36, and the significance of the chi² test (i.e. $p < 0.001$). The equation may Employee Motivation = f (Job security). It may be concluded that there is an association between job security and employee motivation.

6.4.6 Status of GPF, CPF and FBAR Entertained by the Public and Private Banks

The present status regarding GPF and CPF of the four state-owned or public and six private banks has been highlighted on the basis of fringe benefits provided as per rules and policy of the banking sector of Bangladesh.

Table 6.27: GPF and CPF and family benefits after retirement (FBAR)

Bank	Established	Bank & Category	GPF entertained	CPF entertained	FBAR
SBL	1972	Public/nationalized Commercial and Conventional Bank	GPF up to 2007	CPF entertained after converting into public limited or corporatization, i.e., since 15 November 2007	Entertained
JBL	1972		GPF up to 2007		Entertained
ABL	1972		GPF up to 2007		Entertained
RAKUB	BKB 1977; RAKUB 1987	Public and Specialized Bank	GPF 1987	-	Entertained
PBL	1959	Private Commercial and Conventional Bank	GPF Not entertained	CPF entertained	Not entertained
UBL	1965		GPF Not entertained	CPF entertained	Not entertained
NBL	1983		GPF Not entertained	CPF entertained	Not entertained
DBBL	1995		GPF Not entertained	CPF entertained	Not entertained
BRAC	1995		GPF Not entertained	CPF entertained	Not entertained
BRAC Bank	2001		GPF Not entertained	CPF entertained	Not entertained

Source: Division Offices of the Banks, Rangpur

The Table 6.27 showing GPF and CPF entertained by the banks are not the same according to bank category. GPF is offered for those employees employed before the

corporatization of the three public commercial and conventional banks like- SBL, JBL and ABL. After 15 November 2007 recruited employees are treated as CPF. RAKUB is a government and specialized bank and its employees are entertained GPF and their families getting retirement facilities. In this regard employees' satisfaction varies of the banks. Private Banks always entertain CPF for their employees.

6.4.7 Incentives and Individual Performance of the Respective Banks

Banking organization provides different types of incentives on the basis of year wise as well as individual performance. Here are the highlights given below the distribution of incentives of the ten banks. In this case, it has been shown the variation of incentives as per the policies of different banks (Table 6.28).

Table 6.28: Distribution and entertainment of yearly incentives and individual performance

Name of the Bank	Distribution of incentives	Incentive based	Variation of incentives	Status on incentives
SBL	Yearly and equal distribution	Yearly on organizational productivity	No variation	Similar status
JBL	Yearly and equal distribution	Yearly on organizational productivity	No variation	
ABL	Yearly and equal distribution	Yearly on organizational productivity	No variation	
RAKUB*	Yearly and equal distribution	Yearly on organizational productivity	No variation	Not same due to postponed
PBL	Yearly and equal distribution	Yearly on organizational performance	No variation	Same status but varies bank to bank in the number of incentives given
UBL	Yearly and equal distribution	Yearly on organizational outcomes	No variation	
NBL	Yearly and equal distribution	Yearly on organizational performance	No variation	
DBBL	Yearly but not equally distributed	Yearly on individual and organizational outcomes	Variation	Not same due to the no. of incentives
PRIMEBL	Yearly but not equally distributed	Yearly on individual and organizational productivity	Variation	Not same due to the number of incentives given
BRAC	Yearly but not equally distributed	Yearly on individual and organizational performance	Variation	Performance but at least one incentive.

Source: Rangpur Division and Zonal Offices of the Banks

* In 2018 incentive has not been entertained by RAKUB due to adjust the accumulated loss of the previous years.

The Table 6.28 above shows that public limited banks distribute incentives equally among employees on the basis of organizational output or higher profits. On the other hand, private banks except NBL offer incentives among existing employees

based on individual performance i.e., so the variation is found in this regard. It has also been observed that number of incentives entertained in the different years by the different banks but not same that depend on individual and organizational performances.

6.5 Leave Benefits (LBs) in the Banks

Many companies offer vacation benefits that allow employees to take time off from work for a variety of reasons. A waiver of benefits - paid, unpaid or partially paid - is usually a settlement between the employer and the employee, or employee representatives. The banking organizations offer the different kinds of leave benefits for their existing employees they enjoy. In this section the researcher has examined the various leaves enjoying by the existing employees in the banks (Table 6.29 to 6.41).

6.5.1 Statistical Analysis of Leave Benefits in the Banks

Table 6.29: Maternity leave (MtL)

Perception	Freq.	%	Remarks
Never	4	1.0	It is found that (Table 6.29) the highest number of the employees being got maternity leave.
Very often	92	23.0	
Always	304	76.0	
Total	400	100.0	

Table 6.30: Paternity leave (PtL)

Perception	Freq.	%	Remarks
Never	382	95.5	Table 6.30 shows that 95.5% of the respondents do not get paternity leave. It has being observed very few number of the private bank gives paternity leave.
Sometimes	2	0.5	
Often	1	0.3	
Very often	12	3.0	
Always	3	.8	
Total	400	100.0	

Table 6.31: Medical leave (MdL)

Perception	Freq.	%	Remarks
Never	4	1.0	It has noticed (Table 3.31) that majority (56+41.8) % of the employees being got medical benefits.
Sometimes	2	0.5	
Often	3	0.8	
Very often	224	56.0	
Always	167	41.8	
Total	400	100.0	

Table 6.32: Study leave for higher education and development (StL)

Perception	Freq.	%	Remarks
Never	252	63.0	It is being observed (Table 6.32) that 63% (highest) of the respondents do not get (never) study leave for higher study to develop them.
Sometimes	110	27.5	
Often	27	6.8	
Very often	9	2.3	
Always	2	0.5	
Total	400	100.0	

Table 6.33: Recreation leaves with allowances consecutive three years (RcL)

Perception	Freq.	%	Remarks
Never	72	18.0	From Table 6.33 the researcher has got that 46.3% of the participants get recreation leave (after 3 years) with allowances. Public bank gives this benefits is noticed.
Sometimes	6	1.5	
Often	18	4.5	
Very often	185	46.3	
Always	119	29.8	
Total	400	100.0	

Table 6.34: Mandatory leave year wise (MnL)

Perception	Freq.	%	Remarks
Never	308	77.0	It has noticed (Table 6.34) that majority number (77%) of the respondents replied that they do not get yearly mandatory leave. It has also observed that this opportunity entertains by private bank limited.
Sometimes	12	3.0	
Often	6	1.5	
Very often	40	10.0	
Always	34	8.5	
Total	400	100.0	

Table 6.35: Sabbatical leave (SbL)

Perception	Freq.	%	Remarks
Never	383	95.8	Table 6.35 shows that 95.8% (maximum number) of the employees do not have sabbatical leave opportunities from the banking job.
Sometimes	8	2.0	
Often	5	1.3	
Very often	3	0.8	
Always	1	0.3	
Total	400	100.0	

Table 6.36: Occasional leave: national, international, religious, sudden leave etc. (OcL)

Perception	Freq.	%	Remarks
Never	1	0.3	Table 6.36 shows that the 47.3% (majority) of the respondents get occasional leave benefits form the job.
Sometimes	25	6.3	
Often	189	47.3	
Very often	166	41.5	
Always	19	4.8	
Total	400	100.0	

6.5.2 Observation on the Perception of Leave Benefits among Bank Employees

This part of the chapter has discussed on overall perception in case of leave benefits entertained by the banks. It has observed that employees of the different banks face the

challenges under pressure. Employees desire to get the flexibility with enjoying leave. In this section an attempted to make a matrix on frequency distribution (Table 6.5.1).

Table 6.37: Scoring of high, moderate and low motivation level on LB (> 200 or, 50%)

LB	High	Moderate	Low	Observation on level of satisfaction
MtL	396 (99%)	0	4 (1%)	*Employees are not entertained paternity leave and they desire to enjoy it.
PtL*	16 (4%)	0	384 (96%)	
MdL	391 (98%)	3 (1%)	6 (1.5%)	Employees are satisfied with medical leave.
StL**	11 (2.75%)	27 (6.8%)	362 (91%)	** Confined scope in getting study leave for higher study in the banking sector.
RcL	304 (76%)	18 (4.5%)	76 (9.5%)	*** Public banks do not give mandatory leave with after one year. It being observed that many private banks confirm this leave.
MnL***	74 (18.5%)	6 (1.5%)	320 (81%)	
SbL****	4 (1%)	5 (1.3%)	391 (97.8%)	
OcL	185 (46%)	189 (47.3%)	26 (6.3%)	

The above descriptive (Table 6.29 to 6.37) information shows the findings that majority of the employees can not enjoy the paternity, study, mandatory, sabbatical leaves and even the occasional leave like educational institutes they reported.

6.5.3 The Association and Impact of Leave Benefits for Bank Employee

This section has shown the association and relationship among the individual factors involved in leave benefits through using bivariate analysis along with Pearson Correlation (Table 6.38).

Table 6.38: Matrix of bivariate correlation on leave benefits (LBs) and motivation

LB & Scale: (%)	Pearson Correlation, Chi ² -test and Fisher's Exact <i>p</i> -value	
VO (4) + AL (5)	$\alpha=0.01$ ** $\alpha=0.05$ * (2-tailed)	Relationships: Motivation and LB
MtL: 396 (99%)	$r=1$ (cons); perfect correlation p -value $0.009 < \alpha$; H_{01} rejected	Significantly maternity leave influences motivation.
PtL: 16 (4%)	$r = (-0.349)$ ** p -value $0.000 < \alpha$; H_{02} rejected	There is a negative relation between paternity leave and satisfaction.
MdL: 391 (98%)	$r = -0.499$ ** p -value $0.553 < \alpha$; H_{03} rejected	Strong association is found of medical leave and motivation.
StL: 11 (2.75%)	$r = 0.016$ p -value $0.000 < \alpha$; H_{04} rejected	Study leave significantly affects employee motivation.
RcL: 304 (76%)	$r = 0.191$ ** p -value $0.000 < \alpha$; H_{05} rejected	Recreational leave significantly relates employee satisfaction.
MnL: 74 (18.5%)	$r = (-0.444)$ p -value $0.000 < \alpha$; H_0 rejected	Mandatory leave significantly affects motivation.
SbL: 4 (1%)	$r = (-0.114)$ * p -value $0.296 > \alpha$; H_0 accepted	Very few of the banks entertain sabbatical leave. No relationship.
OcL: 185 (46%)	$r = 0.144$ * p -value $0.140 > \alpha$; H_0 accepted	Insignificant relationship between occasional leave and motivation.

Source: Matrix Table compiled from primary data output by the researcher

6.5.4 Factor Analysis on Leave Benefits for Bank Employee

Table 6.39: Descriptive and EFA for leave benefits

Fringe benefits (Leave benefits)	Mean	SD	Test result
Maternity leave (MtL)	4.730	0.564	KMO=0.520 $\chi^2=947.76$ df.=28 Sig.=0.000 (<i>p</i> -value) N=400 Extraction: PCA Remarks: Data are moderately fit for EFA
Paternity leave (PtL)	1.130	0.624	
Medical leave (MdL)	4.370	0.632	
Study leave for higher education (StL)	1.498	0.763	
Recreation leave with allowances after 3 years (RcL)	3.683	1.388	
Mandatory leave yearly (MnL)	1.700	1.366	
Sabbatical leave /periodic leave (SbL)	1.078	0.415	
Occasional leave (OcL)	3.443	0.695	

Table 6.39 shows the mean value of maternity leave, and medical leave are 4.730 and 4.37 representing that these facilities entertaining by bank to the employees is true. Paternity leave, study leave, sabbatical leave have been offered conditionally by the banking sector. The mean values of these three factors are <2.0. Private bank offers yearly mandatory leave for employees.

Table 6.40: EFA and total variance explained on fringe benefits (Leave benefits)

Communalities: Leave Benefits			Total Variance Explained				Remarks on highly loadings
			Initial (1.00) Eigenvalues		Extraction Sums of Squared Loadings		
Components	Initial	Extraction	Total	% of Variance	Total (>1)	% of Variance	
1. Recreation leave (3 years)	1.000	0.941	1.983	33.056	1.983	33.056	Loaded by 73%
2. Mandatory leave (yearly)	1.000	0.927	1.328	22.127	1.328	22.127	
3. Occasional leave	1.000	0.786	1.040	17.325	1.040	17.325	
4. Sabbatical leave	1.000	0.610	0.850	14.168	-	-	-
5. Medical leave	1.000	0.595	0.697	11.618	-	-	-
6. Study leave	1.000	0.492	0.102	1.706	-	-	-

Table All extraction values > 0.40. Total variance explained and loaded covering (1+2+3) **73%**. Maternity and paternity loaded are reduced.

Table 6.40 shows that extraction values of six components are more than 40% the communality values from 1 to 6 out of six factors. There are three factors with Eigenvalues of recreation, mandatory and occasional leave are 1.983, 1.328 and 1.040 respectively more than 1.00. That means, these three components are highly loaded and covered 73% (33.056 +22.127+17.325) of the total variance explained. Employees need to get those types of leave. It is observed that private bank gives per year mandatory leave and public bank ensures recreation leave every three years later. These three variables are most substantial for employee motivation.

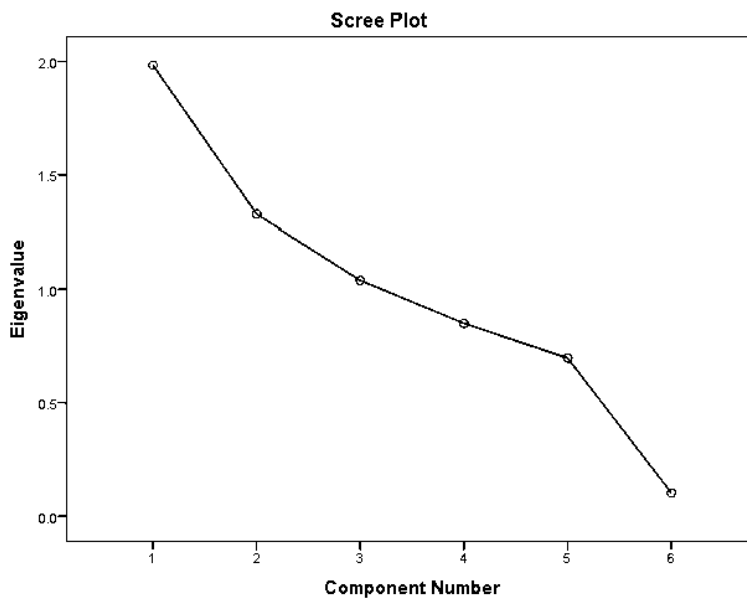

Figure 6.5: Scree plot of leave benefits

Figure 6.5 shows the scree plot of Eigenvalues and depicting two factors are constructing elbow-shaped and maximum proportion variance is explained in the graph. The top three communalities have been extracted i.e., recreation, mandatory and occasional leave are the most significant.

6.5.5 Fringe Benefits between Public and Private Bank

Table 6.41: Comparison of fringe benefits between public and private banks (compiled)

Fringe benefits: JS and LB	Pub_Bank		Pri_Bank		Levene's Test for Equality of Variances		
	Mean	SD	Mean	SD	Mean Difference	F	Sig.
GPF**	3.21	1.98	1.05	0.44	2.16	2409.59	0.000<math>\alpha</math>
CPF**	2.80	1.97	4.73	0.60	-1.93	1765.01	0.000<math>\alpha</math>
Medical benefits*	4.48	0.55	4.30	0.60	0.18	2.37	0.125> <math>\alpha< math><="" td=""> </math>\alpha<>
Accidental death**	2.06	0.87	2.28	1.11	-0.21	16.87	0.000<math>\alpha</math>
Child education**	4.36	0.66	1.21	0.59	3.15	11.56	0.001<math>\alpha</math>
FBAR**	3.21	1.89	1.08	0.35	2.13	1072.60	0.000<math>\alpha</math>
Fringe_JS_Avge**	3.35	1.32	2.44	0.62	0.91	879.67	0.021<math>\alpha</math>
Maternity leave**	4.77	0.54	4.59	0.63	0.18	8.86	0.003<math>\alpha</math>
Paternity leave**	1.04	0.39	1.48	1.09	-0.43	134.9	0.000<math>\alpha</math>
Medical leave**	4.42	0.61	4.16	0.68	0.26	6.36	0.012<math>\alpha</math>
Study leave**	1.51	0.77	1.44	0.74	0.08	0.29	0.588> <math>\alpha< math><="" td=""> </math>\alpha<>
Recreation leave**	4.31	0.60	1.16	0.51	3.15	29.22	0.000<math>\alpha</math>
Mandatory leave**	1.06	0.31	4.28	0.80	-3.22	126.09	0.000<math>\alpha</math>
Sabbatical leave*	1.07	0.39	1.13	0.51	-0.06	5.05	0.25> <math>\alpha< math><="" td=""> </math>\alpha<>
Occasional leave*	3.47	0.69	3.34	0.69	0.13	0.39	0.533> <math>\alpha< math><="" td=""> </math>\alpha<>
Fringe_LB_Avge*	2.71	0.54	2.70	0.71	0.01	38.90	0.173>math>\alpha</math>
Overall	3.03	0.93	2.56	0.66	0.46	459.28	0.097>math>\alpha</math>

NB. Public Bank means Nationalized or State-owned Banks, Statistically ** Significant @ 0.05 (

From Table 6.41 it is being found that the strong and significantly effective factors, namely GPF, CPF, accidental death benefits, child education allowances (

explained that overall job security (JS) is the most significant factor in case of employee motivation in the banking sector of Bangladesh (p -value $0.021 < \alpha$).

6.6 Test of Normality of Motivation on Employee Benefits for Developing Regression Model

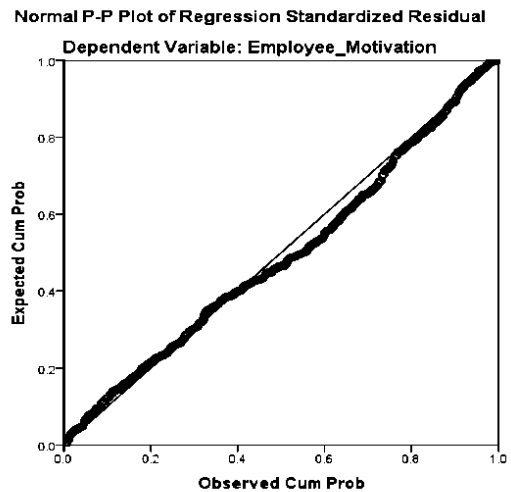
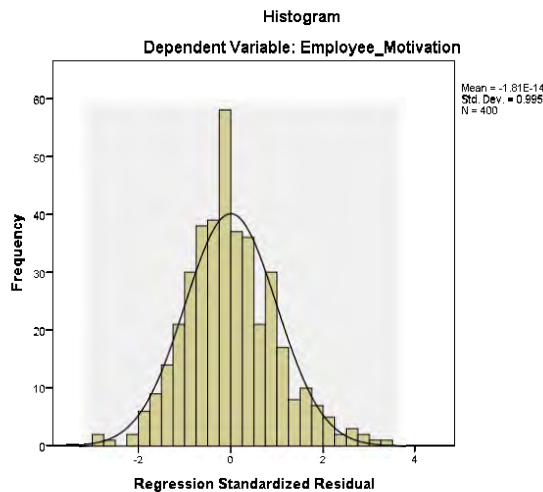

Figure 6.6: Histogram of employee motivation

Figure 6.7: P-P plot of employee motivation

6.6.1 Regression Analysis on Employee Benefits and Motivation

Table 6.42: Coefficients^a of employee benefits (financial and fringe)

Factors of Employee Benefits (Financial and Fringe)	Estimated Coefficients		t-statistic	Sig.	95% Confidence Interval for β		F-Statistic (p-value)
	Regression Coefficient	S.E			LB	UB	
(Constant)	1.475	0.207	7.127	0.000	1.068	1.882	52.611 (0.000)
Financial (FBs, β_1)	0.372* (1)	0.041	9.081	0.000	0.291	0.452	
Other Monetary (OMBs, β_2)	0.032	0.039	0.808	0.420	-0.046	0.109	
Job Security (JS, β_3)	-0.028	0.033	-0.847	0.398	-0.092	0.036	
Leave Benefits (LBs, β_4)	0.352* (2)	0.074	4.784	0.000	0.208	0.497	
a. Dependent Variable: Employee Motivation, (b). Predictors: (Constant), Leave Benefits, Other Monetary Benefits, Job Security, Financial Benefit							
c. R square ~59% , (d) Durbin-Watson 1.742							

6.6.2 Fitted Regression Model on Financial and Fringe Benefits

The fitted of the regression model as shown from the Table 6.42. It can be written as the fitted following regression model as equation form.

The fitted multiple regressions model can be written as:

$$EM = 1.475 * (\alpha) + 0.372 * FBs + 0.032 * OMBs - 0.028 * JS + 0.352 * LBs$$

The β_1 , β_2 , β_3 , and β_4 coefficients findings are 37.5%, 3.2%, 2.8%, and 35.2% (t-statistic, 9.081, 0.808, -0.847, and 4.784; p -values are 0.000, 0.420, 0.398, and 0.000 respectively) times influence of financial, other monetary, job security and leave benefits the employee motivation. The coefficients results are statistically significant p -values are less than 0.05 level of significant in case of *financial* and *leave benefits* but insignificant of the other monetary and job security. The p -value of the model is 0.000 (F, 52.611). Therefore, motivation directly influenced by employee benefits in the banks.

6.7 Discussion on Findings

It has been observed that the existing benefits of salary, profit sharing, bonus and facilities are satisfying the employees. These financial benefits show a high level of satisfaction. But low levels of satisfaction have been found in insurance and transportation facilities. The cuts in salaries, the interruption of growth and the suspension of profits will inevitably increase employee dissatisfaction in the banks. Moreover, existing employees are dissatisfied in case of accidental death benefits along with family benefits after retirement included in GPF. The respondents confirmed that they are enjoying medical benefits. In the nationalized banks do have the GPF but the private banks do not provide GPF and child education allowances.

In the leave benefits employees of the public banks are entertained by the different types of leave except year wise mandatory leave. It also observed over the study that there is a limited scope of sanctioning of study leave. In these cases, employees' satisfaction level shown at lower ones. Profit sharing and postponed of increment are the most effective factors in terms of the latent factors viz. financial and other monetary benefits.

Finally it can be concluded that employees do not always chase after money. In such a situation, financial incentives cannot play a role in providing motivation. In this situation, different measures have to be taken to motivate the employees such as recognition of work, participation in democratic management, job security, fair work environment, good behaviour, ensuring proper training facilities, professional development etc.

Chapter Seven

HRD and Work Environment

7.1 Background of HRD

The focus of HRD environment is how the banking industry confirms the human resource development by organizing different issues internally and externally. It has been highlighted the various factors namely enjoyable workplace, considering HR as the most valuable assets, managers responsibilities for developing employees, human resource planning (HRP), behavioral change programs, supportive culture for developing skills & knowledge, equal opportunities for women.

This chapter has been discussed on the basis of three extents i.e., HRD Environment, Training and Retention, and Quality of Work Life (QWL). The aim of the chapter is to explore the effective factors of HRD environment, training and retention and QWL on employee motivation. It represents the study objective number five and six.

7.2 Training and Retention

Training programs suit the needs of existing employees by pertaining positive attitudes, action, skill, and especially the abilities of existing employees in any organization. Training emphasizes on developing the performance for stabilizing the work force to withstand the knowledge of technology and adaption for making organization as dynamic having strong benefits of motivation and cost effectiveness.

Retention means long-term employment in the banking sector. Permanently employed personnel will be devoted for achieving the goals of the organization. It influences the sustainable effect on motivation. For ensuring the best performance training and retention strategy can be developed affecting assigned tasks and responsibilities of the employees as well.

7.3 Ergonomics and HRD

Ergonomics is how equipment and furniture can be arranged so that people can work efficiently and comfortably or do other activities that serve as the motivational factor which influences the existing employees in the banks. There is a correlation between

ergonomics and HRD environment and QWL. There is a correlation between ergonomics and HRD environment and QWL.

7.4 Significance of QWL

The term Quality of Work Life (QWL) was first introduced by Davis¹, stated as: “Improving the place, the organizations, and the nature of work can be lead to better work performance and a better quality of life in the society”.

Ensuring the highest level of satisfaction it requires a good environment in the workplace. The effect of working environment ultimately signifies the customer satisfaction covering the good image of the banks in connection to competitive sustainability and globalization.^{2&3} Highly motivated employees can contribute with positive behavior towards giving bank’s customers satisfaction.^{4&5} Researchers have showed in the study how employee job satisfaction being affected by demographic factors especially wage changes and how to improve quality of work life can increase the level of satisfaction and reduction stress, results lessening turnover.^{6&7} Studies have been explained that dissatisfaction associated to job complication, ceiled to individual growth and limited support higher level management can protected by execution of relaxing working hours, different developing programs and supports from all corners of management, to increase the level of satisfaction among the existing employees.⁸

¹ Md. Zohurul Islam and Sununta Siengthai, “Quality of Work Life and Organizational Performance: Empirical Evidence from Dhak Export Processing Zone”, Proceedings of ILO Conference on Regulating for Decent Work: Geneva: International Labor Office, 2009.

² Vinita Kaura, and Saroj Kumar Datta, “Impact of Service Quality on Satisfaction in the Indian Banking Sector”, *IUP Journal of Marketing Management*, 2012, Vol. 11 No. 3: 38-47.

³ Sanjit Kumar Roy, C. Padmavathy, M. S. Balaji, and V. J. Sivakumar, “Measuring Effectiveness of Customer Relationship Management in Indian Retail Banks”, *International Journal of Bank Marketing*, 2012, Vol. 30 (4): 246-266.

⁴ Rachita Gulati, “Trends of Cost Efficiency in Response to Financial Deregulation: The Case of Indian Banks. *Benchmarking: An International Journal*, 2015, Vol. 22 No. 5: 808-838.

⁵ Fadzlan Sufian, Fakarudin Kamarudin, and Annuar Md Nassir, “Globalization and Bank Efficiency Nexus: Empirical Evidence from the Malaysian Banking Sector. *Benchmarking: An International Journal*, 2017, Vol.24, No. 5: 1269-1290.

⁶ A. Shamsuzzoha and R. Shumon, “A Study of its Causes and Effects to Different Industries in Bangladesh”, *International Journal of Humanities and Social Science*, July (Special Issue), 2010: 88-89.

⁷ Patric Diriwaechter, and Elena Shvartsman, “The anticipation and adaptation effects of intra-and interpersonal wage changes on job satisfaction. *Journal of Economic Behavior & Organization*, 2018, Vol. 146: 116-140. DOI: 10.1016/j.jebo.2017.12.010.

⁸ Michael P. Leiter, and Christina Maslach, “Areas of Work Life: A Structured Approach to Organizational Predictors of Job Burnout”, in Perrewe, P.L. and Ganster, D.C. (Eds), *Emotional and Physiological Processes and Positive Intervention Strategies*, 2003, Vol.3, Emerald Group Publishing Limited: 91-134.

Working conditions has been changing by the advanced technologies and dynamisms. It has changed the work culture in manufacturing as well as service oriented organizations like banks.⁹ Work environment/QWL enhances productivity, increase level of satisfaction, decreases turnover, absenteeism, reduces costs, possible to maintain quality control, ensures performances, increases profits, and that more the most significant issues for an organization to sustain in the competitive positions.^{10&11}

This chapter includes two sections, namely (Section A) physical variables or ergonomics or quality of working life/ work environment (QWL/WE) and (Section B) HRD environment in the banking sector of Bangladesh. The objective of this chapter is to measure the effect of work environment and HRD environment of employee satisfaction and internal work atmosphere how affects the QWL of the existing HRs. What types of physical factors affect existing employees' quality of work life in the bank? The chapter includes the different factors such as congenial workplace or healthy environment, adequate lighting and ventilation, sophisticated equipment, availability of fire extinguisher, child care unit (CCU), sexual harassment, internal environment and retention, effect of overall work environment on QWL etc.

7.5 Effect of Training and Development, QWL and Retention on Employee Motivation

Table 7.1: Effect of T&D, QWL and retention on employee motivation

Instruments of T&D	Working condition	Retention	Overall
Investment	Trying to improve internal W/E	Fair recruitment	Securing competitive advantage
Seminars-workshops	Good relationship	Job security	
Improving KSA	Safety apparatus	Leave policy	
MBO	Hygienic elements	Fringe benefits	
Participation	Preference for day to day operational decisions	TQM practice	
Problem solving	Immediately fulfilling vacancies	Strategic partner	
Issues and engagement	Considering work load and stress with flexible practice	Equal treatment	
Effect/ Result			
Commitment and loyal	Lead to increase retention	Responsible to stability of tenure	Differentiated and distinguished
Highly motivated with feelings as a corporate citizen and devoted			

Developed by researcher

⁹ Ravindra Nath Mathur, *Quality of Working Life of Women Construction Workers* (New Delhi: Commonwealth Publishers, India, 1989).

¹⁰ Lloyd J. Suttle, *Improving Life at Work: Problems and Prospects*, In J.R. Hackman and J.L. Suttle (eds). *Improving Life at Work: Behavioral Science Approaches to Organizational Change* (1-29), (Goodyear Publishing Company: Santa Monica, California, 1977):1-29.

¹¹ M.K. Newaz, T. Ali, and I. Akhter, "Employee Perception Regarding Turnover Decision in Context of Bangladesh Banking Sector", *BRAC University Journal*, 2007, Vol. 4, No. 2: 67-74.

7.6 HRD Environment

The following are the factors involved in HRD environment which may influence the employees' behavior in the work place. From this section the study has found the effect of HRD on employee motivation (Table 7.1 to 7.15).

7.6.1 Statistical Analysis of HRD Environment

The statistical investigation for justification of HRD environment the empirical results are as follows:

Table 7.2: Top managers sense to ensure employees enjoy their work (Enjoying work)

Perception	Freq.	%	Remarks
Somewhat true	25	6.3	Table 7.2 shows that the majority of the respondents (84.3%) opined priority about top managers' sense enjoy employee's work.
True	338	84.5	
Very much true	37	9.3	
Total	400	100.0	

Table 7.3: Top management trusting HRs are the most valuable asset (Valuable asset)

Perception	Freq.	%	Remarks
A little true	1	0.3	Table 7.3 showing that the study has obtained that 71.3% (maximum) of the respondents agreed about trusting HRs as the most valuable asset considering by top management.
Somewhat true	46	11.5	
True	285	71.3	
Very much true	68	17.0	
Total	400	100.0	

Table 7.4: Managers observed HRD as their responsibility to develop (HRD responsibilities)

Perception	Freq.	%	Remarks
Somewhat true	67	16.8	Table 7.4 shows that the researcher has found that 71.8% (highest) of the employees stated positively about manager observing HRD as responsible for developing subordinates.
True	287	71.8	
Very much true	46	11.5	
Total	400	100.0	

Table 7.5: HRP within the bank creating employee development (HRP_deve)

Perception	Freq.	%	Remarks
Somewhat true	123	30.8	Table 7.5 shows that the highest number of the respondents (63% and 6.8%) believe HRP within the bank developing HRs.
True	250	62.5	
Very much true	27	6.8	
Total	400	100.0	

Table 7.6: Succession plan is made developing employees (Succession_plan)

Perception	Freq.	%	Remarks
A little true	2	0.5	Table 7.6 shows that the highest number of the participants (57% and 3%) witnessed succession plan within structure emerging HRs.
Somewhat true	159	39.8	
True	228	57.0	
Very much true	11	2.8	
Total	400	100.0	

Table 7.7: Managers believe employee behavior can be changed at any stage (Behavior_change)

Perception	Freq.	%	Remarks
A little true	1	0.3	Table 7.7 shows that 48.8% of the respondents believe that employee behavior can be changed in different environment.
Somewhat true	195	48.8	
True	193	48.3	
Very much true	11	2.8	
Total	400	100.0	

Table 7.8: Culture is supportive to any employee by acquiring KSA (Supportive_culture)

Perception	Freq.	%	Remarks
A little true	3	0.8	Table 7.8 shows that the maximum number (51% and 5%) of the employees given priority about culture as the supportive factor in developing interest to employees.
Somewhat true	173	43.3	
True	204	51.0	
Very much true	20	5.0	
Total	400	100.0	

Table 7.9: HRD opportunities assisting to satisfy the employees (HRD_opportunities)

Perception	Freq.	%	Remarks
Somewhat true	23	5.8	Table 7.9 shows that 69.3% of the participants believe that HRD opportunities satisfy the existing employees in the banking sector.
True	277	69.3	
Very much true	100	25.0	
Total	400	100.0	

Table 7.10: Female employees do not face obstacles to receive T&D (EEO)

Perception	Freq.	%	Remarks
Somewhat true	7	1.8	Table 7.10 shows that the majority (65% strongly agreed) of the employees (male and female) get T&D facilities equally.
True	133	33.3	
Very much true	260	65.0	
Total	400	100.0	

7.6.2 Factors and Relationships of HRD Environment

Here is the association of the HRD environment in the banks has been shown through scoring the frequency with Pearson correlation (Table 7.10).

Table 7.11: Score matrix of high frequency and Pearson correlation on HRD environment

HRD env.	High	Moderate	r-value	Observations
Enjoy_work	375 (94%)	25 (6%)	r=1.00 ^{pc}	All the frequencies of HRD environment are > 50% (maximum). Therefore, satisfaction level confirms the favorable to HRD environment in the banking sector. Succession plan shows the highest positive relationship with HRD i.e., r= 0.555 ^{**} and r=1.00 ^{pc} is the perfect correlation (pc). ** Correlation Sig. at 0.001 (2-tailed).
Valuable asset	353 (88%)	46 (12%)	r= 0.488 ^{**}	
HRD_respons	333 (83%)	67 (17%)	r= 0.429 ^{**}	
HRD_deve	277 (69%)	123 (31%)	r= 0.344 ^{**}	
Succsn_plan	239 (60%)	159 (40%)	r= 0.555 ^{**}	
Behav_change	204 (51%)	195 (49%)	r= 0.528 ^{**}	
Supportive_cul	224 (56%)	173 (43%)	r= 0.409 ^{**}	
HRD_opporties	377 (94%)	23 (6%)	r= 0.231 ^{**}	
EEO	393 (98%)	7 (2%)	r= 0.365 ^{**}	

The results of the above analysis (Table 7.2 to 7.11) show that the practices of HRD in the banks are good. Besides, the succession plan is the highly correlated with employee satisfaction.

7.6.3 Effect of HRD Environment on the Employee Motivation

Table 7.12: Matrix of bivariate analysis with highest frequency on HRD environment

HRD environment (Scale: T and VT)	Chi ² of Fisher's Exact Value Test (<i>p</i> -value) and Observation	
	Results, $\alpha=0.05$	Observation
Enjoy_work (94%)	0.985; $>\alpha$ H ₀₁ accepted	Employee enjoys the job insignificantly affecting satisfaction in the banks' HRD environment.
Valuable asset (88%)	0.023; $<\alpha$ H ₀₂ rejected	Considering manpower as a valuable asset significantly influence motivation of the employees.
HRD_respons (83%)	0.000; $<\alpha$ H ₀₃ rejected	Observing HRD as the responsibility to develop subordinates highly influences within the bank.
HRD_deve (69%)	0.000; $<\alpha$ H ₀₄ rejected	HRP development within the bank is highly associated with HRD environment in the banks.
Succsn_plan (60%)	0.001; $<\alpha$ H ₀₅ rejected	There is a strong relationship between succession plan and HRD environment influencing motivation.
Behav_change (51%)	0.006; $<\alpha$ H ₀₆ rejected	Managers believe staff behavior can change and evolve at any stage that is closely related to motivation.
Supportive_cul (56%)	0.684; $>\alpha$ H ₀₇ accepted	Supportive culture to any employee insignificantly affects motivation.
HRD_opporties (94%)	0.063; $>\alpha$ H ₀₈ accepted	HRD informally affects opportunities to help bank employees be satisfied.
EEO (98%)	0.288; $>\alpha$ H ₀₈ accepted	There is no direct impact on the training of bank employees as there is no discrimination between men and women.

From the above Table 7.12 it has been found that the existing staff being spoke positively about the work environment other than the child care unit. In addition, female employees protect themselves from harassment due to strict adherence to banking laws.

7.6.4 Practices of HRD Environment in the Public and Private Bank

Table 7.13: Status of HRD environment between public and private bank

HRD environment	Public Bank		Private Bank		Levene's Test for Equality of Variances			
	Mean	SD	Mean	SD	MD	F	Sig.	Status
Enjoy_work	4.031	0.40	4.025	0.389	0.006	0.063	0.801	Public>Private
Valuable_asset	4.041	0.53	4.088	0.578	-0.045	2.287	0.131	Private>Public
HRD_responsi	3.913	0.52	4.088	0.556	-0.175	4.464	0.012^a	Private>Public
HRP_Deve	3.703	0.56	3.988	0.539	-0.284	24.20	0.000^b	Private>Public
Successin_plan	3.566	0.56	3.838	0.462	-0.272	50.30	0.000^c	Private>Public
Behav_change	3.478	0.55	3.763	0.534	-0.285	11.93	0.000^d	Private>Public
Supportive_cultre	3.553	0.60	3.800	0.560	-0.247	12.48	0.000^e	Private>Public
HRD_opportuni	4.203	0.53	4.150	0.506	0.053	1.614	0.205	*Public>Private
Fair T&D	4.653	0.51	4.550	0.549	0.103	4.568	0.033^f	Public>Private
Overall output	3.905	0.53	4.032	0.519	-0.127	12.43	0.131^g	Private>Public

Remarks: MD= Mean Difference; SD = Standard Deviation; 95% Conf. Interval of the Difference; Sig. (2-tailed). The *p*-value **0.012^a**, **0.000^b**, **0.000^c**, **0.000^d**, **0.000^e**, **0.033^f**, ($p<0.05$) and overall output **0.131^g** insignificant $p>0.05$ i.e., ($p>\alpha$).

In Table 7.13 mean value of HRD opportunities and equally treatment of public bank is greater than the private bank observed. Overall, (MD of public and private bank were 3.905 and 4.032 respectively) HRD environment of private bank and its supportive culture, behavioral change and development, considering employees as assets, HRP planning and development factors are better than the public banking sector in Bangladesh. HRD responsibility, HRP development, succession planning, training for behavioral change, supportive culture and fair training and development have the strong impact on the employee motivation (p -value 0.012^a, 0.000^b, 0.000^c, 0.000^d, 0.000^e, 0.033^f, since $p < 0.05$).

7.6.5 Exploratory Factor Analysis of HRD Environment

Table 7.14: Descriptive statistics and EFA for HRD environment

HRD Environment	Mean	SD	Test result
Top managers sense to ensure employees enjoy their work (Enjoy_work)	4.030	0.393	KMO=0.73 $\chi^2=732.35$ df.=36 p -value=0.000 N=400 EM= PCA Significantly data are good and fit for EFA
Top management considering HRs are the most valuable asset (Valuable_asset)	4.050	0.542	
Managers observe HRD as their responsibility to develop subordinates within the bank (HRD_responsibility)	3.948	0.530	
HRP within the bank make easy employee development (HRP_Deve)	3.760	0.565	
Succession plan is made for developing the employees (Succession_plan)	3.620	0.549	
The managers believe that employee behavior can be changed and developed at any stage of their career (Behav_change)	3.535	0.556	
The culture is supportive to any employee interested in developing by acquiring new knowledge and skills (Supportive_cul)	3.603	0.596	
HRD opportunities assist to satisfy the employees (HRD_opportunities)	4.193	0.521	
Female receive T&D opportunities fairly (Female_T&D)/EEO	4.633	0.518	

Table 7.14 showed that the mean values of all the above nine factors of HRD environment within >3 & 4 (extent or true or very often level). It has being observed that the highest mean value of EEO (MV 4.633). Therefore, HRD environment has been practicing in the banking sector of Bangladesh.

Table 7.15: EFA and total variance explained on HRD environment

Communalities: HRD Environment			Total Variance Explained				Remarks on loadings
			Initial (1.00) Eigenvalues		Extraction Sums of Squared Loadings		
Components	Initial	Extraction	Total	% of Variance	Total (>1)	% of Variance	
1. Enjoying work	1.000	0.694	2.812	31.244	2.812	31.244	62.20% Loaded
2. Succession plan	1.000	0.686	1.465	16.278	1.465	16.278	
3. Valuable asset	1.000	0.668	1.320	14.670	1.320	14.670	
4. Female T&D	1.000	0.667	0.766	8.509	-	-	-
5. HRD opportnitis	1.000	0.666	0.671	7.451	-	-	-
6. Behavi_change	1.000	0.614	0.578	6.428	-	-	-
7. HRP_deve	1.000	0.604	0.508	5.645	-	-	-
8. HRD_responsib	1.000	0.571	0.491	5.451	-	-	-
9. Supportive_cultr	1.000	0.428	0.389	4.323	-	-	-
All extraction values are more than 40% (>0.40). Total variance explained and loaded covering (1+2+3) 62.20%.							

Table 7.15 showed that extraction values of nine components are more than 40% the communality values from 1 to 9 out of nine factors. There are three factors with Eigenvalues of enjoy work, succession plan and valuable asset are 2.812, 1.465 and 1.320 respectively more than 1.00. That means, these three components are highly loaded and covered ~62.20% (31.244 +16.278+14.670) of the total variance explained. Employees want to get enjoyable work place, making succession plan for future responsibility and they think so that they are regarded as valuable asset. These three factors are fundamental to the HRD environment for motivating employees in the banking sector.

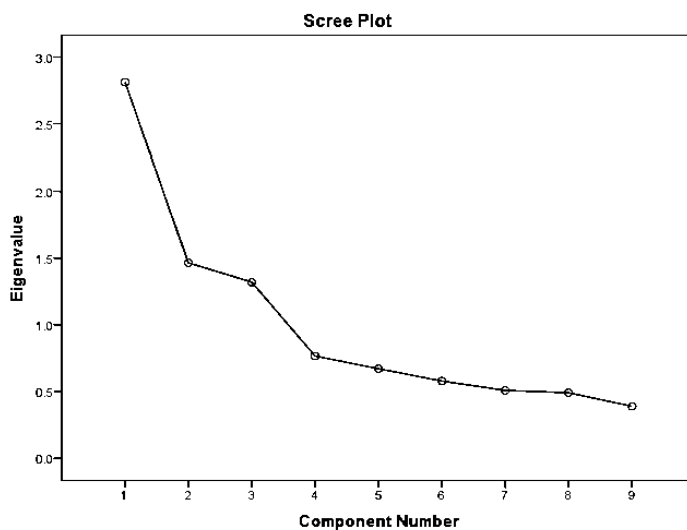

Figure 7.1: Scree plot of HRD environment

Figure 7.1 shows the scree plot of Eigenvalues and depicting two factors are forming elbow-shaped and maximum proportion variance is explained in the graph. The top three communalities have been extracted i.e., enjoy work; succession plan and valuable asset are the most significant of HRD environment.

7.6.6 Measuring the Effective Factors from HRD Environment

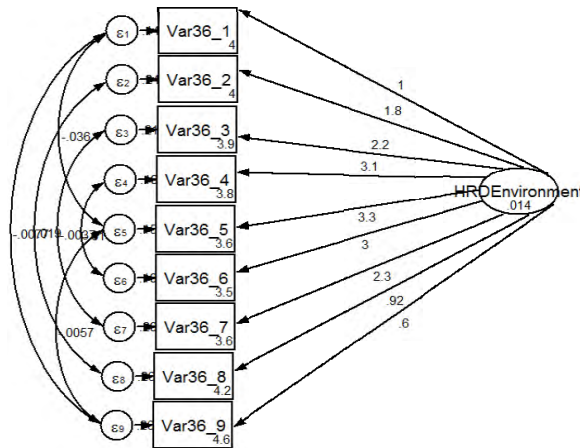

Figure 7.2 shows the SEM for HRD environment (as latent factor; value is 0.014) in the banking sector. The mean values of all factors are also shown in the houses (from 36.1 to 36.9) and the estimated values are in the left.

Figure 7.2: SEM on HRD environment

Table 7.16: Measurement for SEM on HRD environment

Particulars (Measurement)	Coef.	S.E	z	p>z	95% Conf. Interval	
HRD Environment (Latent factor)						
Var36_1 (Enjoy_work)	<-					
	1	(constrained)				
_cons	4.03	0.012	205.32	0.000	3.991	4.068
Var36_2 (Valuable asset)	<-					
	1.834	0.407	4.5	0.000	1.035	2.632
_cons	4.05	0.027	149.77	0.000	3.997	4.103
Var36_3 (HRD_responsibility)	<-					
	2.170	0.491	4.42	0.000	1.209	3.132
_cons	3.948	0.026	149.27	0.000	3.896	3.999
Var36_4 (HRD_Developmnt)	<-					
	3.112	0.854	3.64	0.000	1.438	4.786
_cons	3.76	0.028	133.48	0.000	3.705	3.815
Var36_5 (<i>Succession plan</i>)	<-					
	3.272	0.859	3.81	0.000	1.588	4.956
_cons	3.62	0.027	132.05	0.000	3.566	3.674
Var36_6 (Behavioral_change)	<-					
	3.022	0.842	3.59	0.000	1.371	4.674
_cons	3.535	0.028	127.23	0.000	3.481	3.589
Var36_7 (Supportive_culture)	<-					
	2.319	0.618	3.75	0.000	1.108	3.531
_cons	3.603	0.030	121.01	0.000	3.544	3.661
Var36_8 (HRD_opportunities)	<-					
	0.916	0.303	3.03	0.002	0.323	1.509
_cons	4.193	0.026	161.24	0.000	4.142	4.243
Var36_9 (Fair_T&D)	<-					
	0.603	0.287	2.1	0.036	0.040	1.166
_cons	4.633	0.026	179.16	0.000	4.582	4.683
var(HRD Environment)	0.014	0.007			0.006	0.037
var(e.Var36_1)	0.140	0.011			0.119	0.163
var(e.Var36_2)	0.243	0.012			0.208	0.286

var(e.Var36_3)	0.212	0.018			0.180	0.250
var(e.Var36_4)	0.177	0.020			0.143	0.220
var(e.Var36_5)	0.146	0.017			0.117	0.181
var(e.Var36_6)	0.177	0.012			0.142	0.230
var(e.Var36_7)	0.277	0.021			0.237	0.322
var(e.Var36_8)	0.258	0.019			0.224	0.298
var(e.Var36_9)	0.262	0.019			0.228	0.302
cov(e.Var36_5,e.Var36_1)	-0.036	0.011	-3.33	0.001	-0.057	-0.015
cov(e.Var36_9,e.Var36_1)	-0.008	0.010	-0.77	0.442	-0.027	0.012
cov(e.Var36_8,e.Var36_2)	0.019	0.014	1.37	0.172	-0.009	0.045
cov(e.Var36_7,e.Var36_3)	-0.004	0.014	-0.27	0.788	-0.031	0.023
cov(e.Var36_6,e.Var36_4)	-0.010	0.016	-0.65	0.517	-0.041	0.021
cov(e.Var36_9,e.Var36_5)	-0.006	0.012	-0.47	0.636	-0.029	0.018
Log likelihood= -2551.95; LR test: independent vs. saturated: $\chi^2(36) = 734.21$ Prob> $\chi^2 = 0.0000$						

Table 7.16 showing information on how the SEM is specified by listing the observed variables with coefficient values of latent factor *HRD Environment* ($\beta=0.014$) are congenial work environment ($\beta=1$ constrained: Enjoyable work environment), HR valuable asset ($\beta=1.834>1$), HRD responsibilities ($\beta=2.170>1$), HRD development ($\beta=3.112>1$), succession plan ($\beta=3.272>1$), behavioral change ($\beta=3.022>1$), supportive culture ($\beta=2.319>1$), HRD opportunities ($\beta=0.916$ near to 1) and fair T&D ($\beta=0.603<1$, or near to 1).

The study found standardized factor loads because the variant HRD environment 1 was set to scale the latent variable and identify the model. The standardized factors loading for the *succession plan*, variable and coefficient value is $\beta=3.272$ which is >1 ; most effective and significant, meaning that standard deviation increases in *HRD Environment* leads to a 3.272 standard deviation increases in the response to the said factors effective in the model. The coefficient value of remaining one factor that means *fair T&D* is near to 1 leads the model effective as well. Therefore, it is the best measure of *HRD Environment*.

The model chi-square value, $\chi^2(36) = 734.21$ Prob> $\chi^2 = 0.0000$, is highly statistically significant (p -value <0.05) indicating the model reproduces the observed covariance among all factors very well. Null hypothesis (H_0) fits in this case. A p -value of 0.000 is less than 0.05, the ideal cut-off for testing, which means the null assumption is discarded and the model becomes better. The overall model fits extremely well which means that the specific latent variable as the HRD environment is directly involved in all the factors applied to measure CFA. The output also provides with the chi-square value of 734.21, with the degree of freedom 36,

and the significance of the chi-square test (i.e. $p < 0.001$). The equation may be, $EM = f$ (HRD Environment).

7.6.7 Findings of the HRD Environment

In the EFA there are three factors such as enjoyable work place, succession plan, and considering HR as the most valuable asset highly loaded and covered by 62.20% variance explained. The latent factor HRD environment ($\beta = 0.014$) practices whereas the study has been found that coefficient values of all the factors of the latent factors are greater than 1 or near to 1. The most significant issue of the HRD environment is succession plan ($\beta = 3.272 > 1$). Therefore, all these factors are the strongly significant effect of the latent variable. The study being found that practices of HRD environment of private bank (MV 4.032) is higher than the public bank (MV 3.905).

7.7 Training and Retention

Training can change the behavior of employees in the job performance. There is a positive relationship between training and performance as well as satisfaction or motivation. Retention on the other hand, ensures the long-term employment which may influence the motivation. In this section (Table 7.16 to 7.32) the study has been attempted to find out the effect of training and retention on the employee motivation covering the objective number five.

7.7.1 Statistical Investigation of Training and Retention

Table 7.17: Practices of well-designed training policy (PTP) in the bank

Perception	Freq.	%	Remarks
A little true	1	0.3	Table 7.17 showed that the 56% (highest) of the respondents believed a well-designed training policy practiced in the bank.
Somewhat true	8	2.0	
True	224	56.0	
Very much true	167	41.8	
Total	400	100.0	

Table 7.18: Top management hunts future talent (HFT) utilizing their potentialities

Perception	Freq.	%	Remarks
Not at all true	2	0.5	Table 7.18 showed that the 38.3% (highest) of the participants agreed (true level) that sampled banks trying to hunt future talent and utilizing potential through arranging training program.
A little true	72	18.0	
Somewhat true	118	29.5	
True	153	38.3	
Very much true	55	13.8	
Total	400	100.0	

Table 7.19: Newly recruited employees are given induction training (Ind_Tr)

Perception	Freq.	%	Remarks
A little true	1	0.3	Table 7.19 elucidates that 77% (majority) of the respondents acknowledged that banking sector organized induction training for new recruited employees.
Somewhat true	20	5.0	
True	308	77.0	
Very much true	71	17.8	
Total	400	100.0	

Table 7.20: Sr. managers supervise and prepare their immediate juniors (Supervision)

Perception	Freq.	%	Remarks
A little true	1	0.3	From Table 7.20 the study being found that 68.5% (maximum and extent level) of the participants perceived that their senior managers guide and supervise juniors.
Somewhat true	103	25.8	
True	274	68.5	
Very much true	22	5.5	
Total	400	100.0	

Table 7.21: Employees training feedback is positive on performance driven (T-feed)

Perception	Freq.	%	Remarks
A little true	1	0.3	It being observed (Table 7.21) that 77.5% (highest) of the respondents believed that training feedback affecting employees' performance.
Somewhat true	59	14.8	
True	310	77.5	
Very much true	30	7.5	
Total	400	100.0	

Table 7.22: Job-rotation in the bank enhances employee development (J-rotation)

Perception	Freq.	%	Remarks
A little true	1	0.3	Table 7.22 explains that 66.3% of the contributors truly observed that job rotation enhancing employee development.
Somewhat true	100	25.0	
True	265	66.3	
Very much true	34	8.5	
Total	400	100.0	

Table 7.23: Senior delegating authority and responsibility to juniors (DoA)

Perception	Freq.	%	Remarks
A little true	5	1.3	Table 7.23 clarifies that 56.5% of the respondents replied at extent level senior delegating authority to juniors.
Somewhat true	146	36.5	
True	226	56.5	
Very much true	23	5.8	
Total	400	100.0	

Table 7.24: Training increases commitment leading to low turnover (Low_Turnover)

Perception	Freq.	%	Remarks
Somewhat true	40	10.0	Table 7.24 shows that 74.5% of the participants believed truly that training increases employees' commitment leading to low turnover and continuing job.
True	298	74.5	
Very much true	62	15.5	
Total	400	100.0	

Table 7.25: Employee training provided by the bank increases retention (Incre_retention)

Perception	Freq.	%	Remarks
A little true	1	0.3	It being noticed (Table 7.25) that maximum (63.3%) number of the respondents acknowledged that training provided by the sampled banks increasing retention.
Somewhat true	55	13.8	
True	253	63.3	
Very much true	91	22.8	
Total	400	100.0	

Table 7.26: Sustainable training (Sus_training)

Perception	Freq.	%	Remarks
Somewhat true	16	4.0	From Table 7.26 researcher has found that 55% of the respondents replied truly that sampled banking organizations arranged sustainable training programs.
True	220	55.0	
Very much true	164	41.0	
Total	400	100.0	

7.7.2 Relationships of Factors Included in Training and Retention

This unit has shown the associations among the variables included in the training and retention through using Pearson Correlation and and score matrix developed from frequency (7.17- 7.26).

Table 7.27: Scores of high and Pearson correlation on training and retention

Factors	High	Moderate	r-value	Observation and remarks
PTP	391 (98%)	8 (2%)	r= 1.00 ^{pc}	It is being observed that employee training and retention practices in the banking sector are highly acceptable (>50%) level of perception and confirming practices of training policy. Therefore, existing employees are satisfied with the sustainable (96%) training policy arranging by the banks. ** Correlation at 0.01 (2-tailed) and perfect correlation (pc).
HFT	208 (52%)	118 (29.5%)	r=0.022	
Ind_T	379 (95%)	20 (5%)	r=0.183 ^{**}	
Superv	296 (74%)	103 (25.8%)	r=0.182 ^{**}	
T_Feed	340 (85%)	59 (14.8%)	r=0.393 ^{**}	
J_rotation	299 (75%)	100 (25%)	r=0.586 ^{**}	
DoA	249 (62%)	146 (36.5%)	r=0.446 ^{**}	
Low_turn	360 (90%)	40 (10%)	r=0.031	
Incre_retention	344 (86%)	55 (13.8%)	r=0.395 ^{**}	
Sus_training	384 (96%)	16 (4%)	r=0.298 ^{**}	

The above analysis (Table 7.17–7.27) explains that overall practices of training and retention strategies have been found in the banking sector of Bangladesh. Moreover, it is being noticed that the job rotation is the highly correlated with the training and retention policies in banks.

7.7.3 Impact of the Association on Training and Retention

The effect of training and retention has been discussed by using chi-square test in terms of the nature of bank (Table 7.28).

Table 7.28: Bivariate analysis of training and retention by crosstabs of bank nature

T & R	Public Bank	Private Bank	Chi ² test of Fisher's Exact <i>p</i> -value hypothesized results and impact
Practices of well-designed training policy (PTP) in the bank			
A little true	1 (0.05%)	0 (0%)	Observed that $p=0.045$. Statistically alternative hypothesis (H_a) accepted. An association is existed between training policy and motivation of the employee.
Somewhat true	7 (2%)	1 (1%)	
True	184 (58%)	40 (50%)	
Very much true	128 (40%)	39 (49%)	
Top management hunts future talent (HFT) utilizing their potentialities			
Not at all	2 (1%)	0 (0%)	Since $p=0.000$. H_a statistically confirmed. Therefore, highly relationship exists between talent hunt and satisfaction in the banks.
A little true	66 (21%)	6 (8%)	
Somewhat true	106 (33%)	12 (15%)	
True	115 (36%)	38 (48%)	
Very much true	31(10%)	24 (30%)	
Newly recruited employees are given induction training (Ind_Tr)			
A little true	0 (0%)	1 (1%)	Since $p =0.39$; H_a not supported. Association between induction training and types of bank is insignificant. Thus, H_o is accepted.
Somewhat true	18 (6%)	2 (3%)	
True	248 (78%)	60 (75%)	
Very much true	54 (17%)	17 (21%)	
Sr. managers supervise and prepare their immediate juniors (Supervision)			
A little true	1 (0.05%)	0 (0%)	Got p -value 0.05. H_a being failed to reject. There is positive relationship in case of satisfaction between promotion policy and type of bank.
Somewhat true	87 (27%)	16 (20%)	
True	214 (67%)	60 (75%)	
Very much true	18 (5.63%)	4 (5%)	
Employees training feedback is positive on performance (T-feed)			
A little true	1 (0.05%)	0 (0%)	Since $p=0.79$ H_a not accepted. There is no relationship in case of satisfaction between training feedback and types of bank.
Somewhat true	54 (17%)	5 (2%)	
True	242 (76%)	68 (85%)	
Very much true	23(7%)	7 (8.8%)	
Job-rotation in the bank enhances employee development (J-rotation)			
A little true	1 (0.05%)	0 (0%)	Found that $p=0.24$; statistically H_o is supported. Job rotation and types of bank have not any direct association.
Somewhat true	88 (28%)	12 (15%)	
True	206 (64%)	59 (74%)	
Very much true	25 (8%)	9 (11%)	
Senior delegating authority and responsibility to juniors (DoA)			
A little true	5 (2%)	0 (0%)	The p -value is 0.030. There is a close relationship between delegation of authority and long-term employment affecting employee motivation in the banking sector of Bangladesh.
Somewhat true	125 (39%)	21 (26.25%)	
True	175 (55%)	51 (64%)	
Very much true	15 (5%)	8 (10%)	
Training increases commitment leading to low turnover (Low_Turnover)			
Somewhat true	28 (9%)	12 (15%)	Since $p=0.172$; H_a not accepted. In the banking organization training insignificantly influences employee turnover and motivation.
True	239 (75%)	59 (74%)	
Very much true	53 (17%)	9 (11%)	
Employee training provided by the bank increases retention (Incre_retention)			
A little true	0 (0%)	1 (1%)	It being found that the insignificant impact of training on retention (since $p=0.217$) in the types of bank.
Somewhat true	41 (13%)	14 (18%)	
True	205 (64%)	48 (60%)	
Very much true	74 (23%)	17 (21%)	
Sustainable training (Sus_training)			
Somewhat true	14 (4%)	2 (3%)	Banks have arranged sustainable training programs continuously. As p -value is 0.282. Thus, no impact of sustainable training on employee retention in terms of the nature of bank.
True	170 (53%)	50 (63%)	
Very much true	136 (43%)	28 (35%)	

7.7.4 Factor Analysis on Training and Retention

Table 7.29: Descriptive statistics and EFA for training and retention

Practices in the areas	Mean	SD	Test result
Well-designed training policy in the bank (PTP)	4.392	0.542	KMO=0.72 $\chi^2=623.78$ df.=45 Sig.=0.000 N=400 Method: PCA Data are suitable for EFA
Hunting future talent and utilizing (HFT)	3.468	0.957	
Induction training (IndT)	4.123	0.472	
Sr. managers supervise juniors (Supervision)	3.793	0.529	
Training feedback affects performance (T_feed)	3.923	0.477	
Job-rotation enhances development (J_rotation)	3.830	0.563	
Sr. delegates authority and responsibility (DoA)	3.668	0.602	
Training leading to low turnover (Low_turnover)	4.055	0.503	
Employee training increases retention (Incre_retention)	4.085	0.607	
Sustainable training (Sus_training)	4.370	0.560	

The above Table 7.29 shows training and retention of the banking sector. The mean values (more than 3 and 4; extent level) of all factors are good figure. The mean values are more than 4 observed in the proper training policy, sustainable training, induction training, increased retention and low turnover of employees. The other factors and their mean values are more 3 or near to 4. The KMO value is 71.6% and data are significantly fit for EFA.

Table 7.30: EFA and total variance explained for training and employee retention

Communalities: Training and Employee Retention			Total Variance Explained				Remarks on highly loadings
			Initial (1.00) Eigenvalues		Extraction Sums of Squared Loadings		
Components	Initial	Extraction	Total	% of Variance	Total (>1)	% of Variance	
1. J_rotation	1.000	0.681	2.612	26.123	2.612	26.123	Loaded by 53%
2. Feedback	1.000	0.635	1.623	16.226	1.623	16.226	
3. Low_turn	1.000	0.626	1.095	10.952	1.095	10.952	
4. Rentention	1.000	0.617	0.979	9.787	-	-	
5. IndT	1.000	0.608	0.823	8.227	-	-	-
6. Sus_training	1.000	0.528	0.723	7.230	-	-	-
7. DoA	1.000	0.510	0.663	6.629	-	-	-
8. Supervision	1.000	0.421	0.583	5.832	-	-	-
9. HFT	1.000	0.413	0.521	5.208	-	-	-
10. PTP*	1.000	0.292	0.379	3.786	-	-	-

*Extraction value is less than 0.40.Total variance explained and loaded covering (1+2+3) 53%.

Table 7.30 showed that extraction values of nine components are more than 40% the communality values from 1 to 9 out of ten factors. There are three factors with Eigenvalues of job rotation, training feedback and low turnover are 2.612, 1.623 and 1.095 respectively more than 1.00. That means, these three components are highly loaded and covered ~53% (26.123 +16.226+10.952) of the total variance explained. Employees are motivated to participate in rotated job, receiving feedback and finally

they will sustain themselves in the service for a long time. These three factors are the most extensive for employee motivation of the banking sector. Both banks do have proper training policy (PTP).

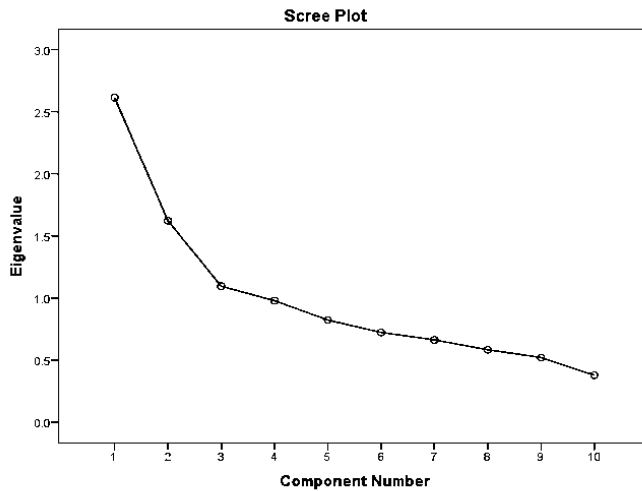

Figure 7.3 shows the scree plot of Eigenvalues and depicting two factors are creating elbow-shaped and maximum proportion variance is explained in the graph. The top three communalities have been extracted i.e., job rotation, training feedback and low turnover are the most significant.

Figure 7.3: Scree plot of training and retention

7.7.5 Comparative Analysis of the Practices of Training and Retention between Private and Public Bank

Table 7.31: Status of training and retention in the public and private bank

Factors	Public Bank		Private Bank		Levene's Test for Equality of Variances			
	Mean	SD	Mean	SD	MD	F	Sig.	Status
PTP	4.37	0.55	4.48	0.53	-0.10	0.150	0.120	Private>public
HFT	3.33	0.93	4.00	0.87	-0.67	10.000	0.000^a	Private>public
IndT	4.11	0.46	4.16	0.51	-0.05	1.620	0.340	Private>public
Supervision	3.78	0.54	3.85	0.48	-0.07	5.400	0.020^b	Private>public
Feedback	3.90	0.49	4.03	0.39	-0.13	9.500	0.000^c	Private>public
J_rotat	3.80	0.57	3.96	0.51	-0.17	12.400	0.000^d	Private>public
DoA	3.63	0.60	3.84	0.58	-0.21	7.520	0.001^e	Private>public
Low_turn	4.08	0.50	3.96	0.51	0.17	0.110	0.070	Public>private
Incre_retent	4.10	0.59	4.01	0.67	0.09	0.010	0.280	Public>private
Sus_train	4.38	0.57	4.33	0.52	0.06	3.900	0.050^f	Public>private
Overall	3.95	0.58	4.06	0.56	-0.11	5.060	0.090^g	*Private>public

NB: MD= Mean Difference; SD = Standard Deviation; 95% Conf. Interval of the Difference; Sig. (2-tailed). The p -value **0.000^a**, **0.021^b**, **0.002^c**, **0.000^d**, **0.004^e**, **0.049^f**, ($p < 0.05$) and overall output **0.0891^g** insignificant $p > 0.05$ i.e., ($p > \alpha$).

Overall mean value of private bank in case of practices of training policy, future talent hunting, induction of new employees, performance based and feedback training, supervision of senior managers, job rotation training and delegation of authority to

juniors are higher than the mean value of public bank (Table 7.31). But it is being observed in terms of turnover rate, retention and sustainable training of the public banking sector are greater than the private bank in Bangladesh.

7.7.6 Exploring the Effective Factors from Training and Retention by Using SEM

The study being explored the most effective factors related to the training and retention practices (considered as latent variable) in the banking industry. In this case SEM has been applied to explore the highly effective factors that influence employee motivation (Table 7.32 and Figure 7.4).

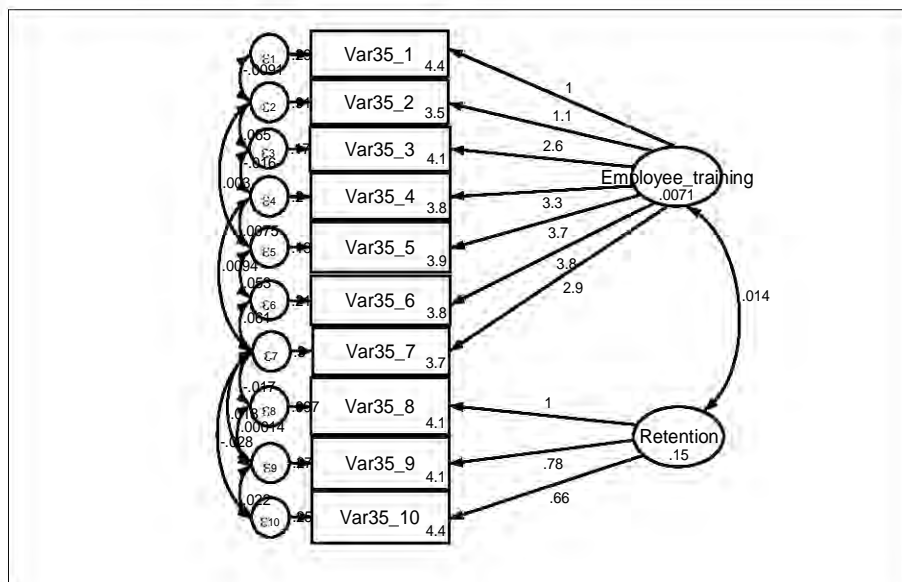

Figure 7.4: SEM of training and retention

Figure 7.4 shows SEM of the two latent factors, namely LF1 employee training and LF2 retention. The estimated coefficient values are extracted from the SEM constructs 0.007 and 0.15 respectively. The figure shows all mean values of all the factors regarding HR training and retention into 35.1 to 35.10 in the houses.

Table 7.32: SEM and measurement of training and retention in the Banking Sector

Measurement	Coef.	S.E	z	p>z	95% Conf. Interval	
Training (Latent variable:LF1)						
Var35_1 (PTP)	<-					
	1	(constrained)				
_cons	4.4	0.03	162.2	0.000	4.339	4.446
Var35_2 (HFT)	<-					
	1.108	0.91	1.2	0.222	-0.671	2.886
_cons	3.5	0.05	72.5	0.000	3.374	3.561
Var35_3 (IndT)	<-					

	2.60	1.07	2.4	0.016	0.486	4.697
_cons	4.4	0.03	162.2	0.000	4.339	4.446
Var35_4 (Supervision)	<-					
	3.3	1.60	2.1	0.037	0.194	6.472
_cons	3.8	0.03	143.6	0.000	3.741	3.844
Var35_5 (Feedback)	<-					
	3.7	1.83	2.03	0.043	0.119	7.290
_cons	3.9	0.03	164.9	0.000	3.876	3.970
Var35_6 (J_rotat)	<-					
	3.8	1.84	2.1	0.040	0.181	7.388
_cons	3.8	0.03	136.7	0.000	3.775	3.885
Var35_7 (DoA)	<-					
	2.9	1.44	2.0	0.042	0.101	5.741
_cons	3.7	0.03	122.5	0.000	3.609	3.726
Retention or long-term employment (Latent variable: LF2)						
Var35_8 (Low_turn)	<-					
	1	(constrained)				
_cons	4.1	0.03	161.6	0.000	4.006	4.104
Var35_9 (Incre_retent)	<-					
	0.8	0.23	3.4	0.001	0.331	1.221
_cons	4.1	0.03	134.7	0.000	4.026	4.144
Var35_10 (Sus_training)	<-					
	0.7	0.20	3.2	0.001	0.260	1.060
_cons	4.4	0.03	156.2	0.000	4.315	4.425
Var (Employee training;LF1)	0.01	0.01			0.001	0.040
Var (Retention;LF2)	0.16	0.05			0.083	0.289
var(e.Var35_1)	0.29	0.02			0.330	0.2484
var(e.Var35_2)	0.91	0.07			0.788	1.043
var(e.Var35_3)	0.18	0.02			0.143	0.214
var(e.Var35_4)	0.2	0.02			0.158	0.252
var(e.Var35_5)	0.13	0.02			0.092	0.180
var(e.Var35_6)	0.30	0.03			0.252	0.352
var(e.Var35_7)	0.3	0.03			0.252	0.352
var(e.Var35_8)	0.10	0.05			0.038	0.251
var(e.Var35_9)	0.3	0.06			0.183	0.412
cov(e.Var35_1,e.Var35_2)	0.01	0.03	0.36	0.721	0.059	0.041
cov(e.Var35_2,e.Var35_3)	0.1	0.02	2.72	0.006	0.018	0.111
cov(e.Var35_2,e.Var35_5)	0.01	0.02	0.15	0.877	-0.035	0.041
cov(e.Var35_3,e.Var35_4)	-0.02	0.01	-1.11	0.266	-0.044	0.012
cov(e.Var35_4,e.Var35_5)	0.01	0.01	0.53	0.597	-0.020	0.035
cov(e.Var35_4,e.Var35_7)	0.01	0.02	0.58	0.565	-0.023	0.041
cov(e.Var35_5,e.Var35_6)	0.05	0.02	2.96	0.003	0.018	0.088
cov(e.Var35_6,e.Var35_7)	0.06	0.02	3.97	0.000	0.031	0.091
cov(e.Var35_7,e.Var35_8)	-0.02	0.02	-1.17	0.243	-.045	0.012
cov(e.Var35_7,e.Var35_9)	0.02	0.02	1.06	0.287	-0.015	0.050
cov(e.Var35_7,e.Var35_10)	-0.03	0.02	-1.76	0.078	-0.058	0.003
cov(e.Var35_8,e.Var35_9)	0.000	0.04	0.00	0.997	-0.087	0.087
cov(e.Var35_9,e.Var35_10)	0.02	0.03	0.83	0.407	-0.030	0.073
cov(Training_Retention)	0.014	0.01	1.83	0.067	-0.001	0.029
Number of obs = 400, Estimation method = ml, Log likelihood = -3135.6926, Log likelihood = -2551.95; LR test of model vs. saturated: $\chi^2(21) = 66.55$, Prob > $\chi^2 = 0.000$						

The Table 7.32 gives information about how the model is specified by listing the observed variables with coefficient values of the latent variable *Employee Training*

($\beta=0.007$) are *training policy* ($\beta=1$, constrained), *talent hunting* ($\beta=1.108$; i.e., >1), *induction training* ($\beta=2.60$; >1), *future responsibility* ($\beta=3.33$; >1), *training feedback* ($\beta=3.70$; >1), *job rotation* ($\beta=3.78$; >1), and *delegation of authority-DoA* ($\beta=2.92$; >1). Similarly, the coefficient values of the latent variable *Employee Retention* ($\beta=0.155$; <1) are *committed to low retention* ($\beta=1$, constrained), *increases retention* ($\beta=0.78$), and *sustainable training* ($\beta=0.66$).

The researcher has got standardized factor loadings because the variance for *Employee Training* set to 1 to scale the latent variable and for model identification. The standardized factor loading for the *talent hunting* variable is 1.108, (>1.00) meaning that a one standard deviation increases in *employee training* leads to a 1.108 standard deviation increases in the response to the *talent hunting* in the model. All the other factors are the strongest factors loadings of all the factors since coefficient values are greater than 1. *Job rotation* is the most effective and significant factor of the said latent variable employee training. Therefore, it is the best extent of *HRD Environment*.

Similarly, the standardized factor loadings because the variance for *retention* has been set to 1 to scale the latent variable and for model identification. The standardized factor loading for the *Increases retention* variable is 0.78, meaning that a one standard deviation increases in *retention* leads to a 0.78 standard deviation increases in the response to the *retention* in the model. The test statistic value highly significant (p value= $0.001 < 0.05$) at 5% level of significance. Similarly, the standardized factor loading for the *sustainable training* variable is 0.66, meaning that a one standard deviation increases in *retention* leads to a 0.66 standard deviation increases in the response to the *retention* in the model. The test statistic value highly significant (p -value= $0.001 < 0.05$) at 5% level of significance.

The model chi-square value, $\chi^2(21) = 66.55$, Prob $> \chi^2 = 0.000$, is highly statistically significant indicating the model reproduces the observed covariance among all factors very well. Null hypothesis (H_0) fits in this case. The p -value of 0.000 is less than .05, the typical cut-off for the test, which means that the null hypothesis is rejected and the model fits well. The overall model fits extremely well meaning that the latent variable specified as *employee training* and *retention* are strongly related to the all factors used to measure SEM/CFA. The output also provides with the chi-square value

of 85.29, with the degree of freedom 21, and the significance of the chi-square test (i.e. $p < 0.001$). The equation may be $EM = f(\text{Training} + \text{Retention})$.

Hypothesis (H_a): There is an effect of training and retention on employee motivation in the banking sector.

7.7.7 Structural Relationships and Path Coefficients of Training and Retention

Table 7.33: Results of path coefficients training and retention

Hypothesized Structural Path	<i>p</i> -value	Coefficient	Remarks	Relationship
Motivation<-HRTraining	0.047	0.007	Ha ₁ ; supported	Direct effect
Motivation<-Retention	0.001	0.155	Ha ₂ ; supported	Direct effect
Motivation<-Training & retention	0.048	0.014	Ha ₃ ; supported	Direct effect

Therefore, it is being investigated that a direct effect of training and retention on employee motivation shown (Table 7.33). Talent hunting and its *p*-value is 0.222 and 95% confidence interval between -0.671 to 2.886 (Table 7.34).

7.7.8 Short Findings of Training and Retention

In the EFA three factors such as job rotation, training feedback and low turnover of training and retention are highly loaded and covered by 53% variance explained. The latent factors: Training ($\beta=0.007$) and Retention ($\beta=0.155$) whereas, the study being found that coefficient values of all the factors of latent variable *training* are more than 1. Therefore, these factors are the strongly significant effect of the latent variable. Again, it is comparatively being observed that *retention* is more significant effect than the *training*. The study being found that practices of *Employee Training and Retention* of private bank are better than that of the public bank.

7.8 Quality of Working Life (QWL)

Quality of work life refers to organizational climate where all members of the organizations, through appropriate channels of communication, job designed and work environment set up. Organizational climate is a powerful influence on productivity and it should exhibit opportunities for suggestions, questions and criticisms that might lead to any kind of improvement. If employees feel low-level job satisfaction, they will perceive their work quality as inferior. This section has explored the effective factors of QWL influencing employee motivation (Table 7.33 to 7.46).

7.8.1 Statistical Investigation of QWL

Table 7.34: Workplace is congenial to health (WC)

Perception level	Freq.	%	Remarks
A little true	5	1.3	The researcher found that 65% (maximum) of the employees feel comfortable about their work place (Table 7.34).
Somewhat true	111	27.8	
True	260	65.0	
Very much true	24	6.0	
Total	400	100.0	

Table 7.35: Adequate space for movement, lighting and ventilation (AV)

Perception level	Freq.	%	Remarks
A little true	1	0.3	From the Table 7.35 the study got that about 70% (highest) of the respondents feel positively nearly adequate space and ventilation in the bank.
Somewhat true	101	25.3	
True	279	69.8	
Very much true	19	4.8	
Total	400	100.0	

Table 7.36: Official equipment is updated/ sophisticated (OS)

Perception level	Freq.	%	Remarks
A little true	2	0.5	The study got that about 70% (highest) of the participants feel positively almost the official equipment updated (Table 7.36).
Somewhat true	78	19.5	
True	279	69.8	
Very much true	41	10.3	
Total	400	100.0	

Table 7.37: Existing fire extinguisher is available in the bank branch (EFE)

Perception level	Freq.	%	Remarks
Somewhat true	10	2.5	In Table 7.37 the researcher found that 63% of the respondents given their positive opinion about exiting fire extinguisher available in the branch.
True	252	63.0	
Very much true	138	34.5	
Total	400	100.0	

Table 7.38: Child care unit (CCU)

Perception level	Freq.	%	Remarks
Not at all true	398	99.5	Table 7.38 the researcher found that 99.5% (maximum) of the employees said that they did not get CCU facilities.
A little true	1	0.3	
True	1	0.3	
Total	400	100.0	

Table 7.39: Female employees do not face sexual harassment (FSH)

Perception level	Freq.	%	Remarks
Not at all true	3	0.8	From Table 7.39 researcher has observed that majority (opined 43.8% true and 53.5% very much true) of the respondents do not face sexual harassment.
Somewhat true	8	2.0	
True	175	43.8	
Very much true	214	53.5	
Total	400	100.0	

Table 7.40: Internal environment affecting the employee retention (IER)

Perception level	Freq.	%	Remarks
Not at all true	1	0.3	Table 7.40 the study perceived that the highest number of the employees confessed that internal work atmosphere affects retention.
Somewhat true	74	18.5	
True	284	71.0	
Very much true	41	10.3	
Total	400	100.0	

Table 7.41: Working environment affecting employee motivation (WEM)

Perception level	Freq.	%	Remarks
A little true	15	3.8	Table 7.41 researcher observed that the highest number (235 and 25) of the respondents witnessed that QWL is influenced by ergonomics.
Somewhat true	125	31.3	
True	235	58.8	
Very much true	25	6.3	
Total	400	100.0	

7.8.2 Observation on QWL and Its Score with Pearson Correlation

Table 7.42: Score matrix of frequency (highest > 50%) and correlation on QWL

QWL	High	r-value
Congenial Workplace to health (WC)	71%	r= 1.00 ^{pc}
Adequate space for ventilation (AV)	74.5%	r= 0.648 ^{**}
Sophisticated Official equipment (OS)	80%	r= 0.520 ^{**}
Exist fire extinguisher is available (EFE)	97.5%	r= 0.158 ^{**}
Child care unit (CCU)	0.6%	r= (-0.009)
Female does not face sexual harassment (FSH)	97.3%	r= (-0.256 ^{**})
Internal environment simplifying employee retention (IER)	81.3%	r= 0.197 ^{**}
Working environment affects motivation (WEM)	65.1%	r= 0.410 ^{**}

It is being observed from the scoring Table 7.42 that the perception level ensures that the work environment in the banking sector is favorable (>50%). The adequate space for ventilation shows the most positive relationship with HRD i.e., r= 0.648^{**} and r=1.00^{pc} is the perfect correlation (pc). CCU as well as sexual harassment shows the negative relationship in case of workplace. ^{**}Correlation Sig. at 0.001 (2-tailed).

7.8.3 Bivariate Association of the Factors Involved in QWL

Table 7.43: Bivariate analysis on QWL/WE *bank type

QWL/WE	Chi2 test of Fisher's Exact Value (p -value) and hypothesized Results, $\alpha=0.05$	Observation on the effect of QWL
True and very much true		
Workplace is congenial to health (WC: 71% > 50%)	0.000; < α H ₀₁ rejected	Significantly the workplace is associated with motivation influencing banks' employee motivation.
Adequate space for lighting and ventilation (AV: 74.5% > 50%)	0.000; < α H ₀₂ rejected	Employees' satisfaction is related to adequate space in the bank.
Official equipment is sophisticated (AS: 80% > 50%)	0.000; < α H ₀₃ rejected	Sophisticated tools do have an effect on motivation.
Exist fire extinguisher is available in the bank branch (EFE: 97.5%)	0.609; > α H ₀₄ accepted	Every branch always ready to fight against fire accident. It does not affect motivation.
Child care unit (CCU: 0.6 % < 50%)	0.593; > α H ₀₅ accepted	Child care unit does not influence environment of the bank.
Female employees do not face sexual harassment (FSH: 97.25% > 50%)	0.696; > α H ₀₆ accepted	No relationship is found between sexual bother and workplace in the banks.
Internal environment simplifying employee retention (IER: 81.25% > 50%)	0.001; > α H ₀₇ rejected	Employees are motivated to stay in the long-term. There was a highly relationship between internal environment and retention in the banking sector.
Working environment affects motivation (WEM: 65.1% > 50%)	0.000; < α H ₀₈ rejected	Significantly work environment affects employee motivation in the banks.

Compiled from primary source

From the above Table 7.43 it has been found that the existing staff spoke positively about the work environment other than the child care unit. In addition, female employees protect themselves from harassment due to strict adherence to banking laws.

7.8.4 Comparison of QWL Practices in the Public and Private Banks

Table 7.44: Comparison of QWL between public and private banks

QWL	Public Bank		Private Bank		Levene's Test for Equality of Variances			
	Mean	SD	Mean	SD	MD	F	Sig.	Status on MD
1. WC	3.681	0.591	4.063	0.368	-0.381	76.05	0.000	Private > public bank
2. AV	3.709	0.513	4.113	0.390	-0.403	40.60	0.000	Private > public bank
3. OES	3.819	0.558	4.213	0.412	-0.394	4.123	0.000	Private > public bank
4. EFE	4.303	0.512	4.388	0.539	-0.084	3.050	0.019	Private > public bank
5. CCU	1.013	0.177	1.000	0.000	0.013	1.612	0.206	Public > private bank
6. FSH	4.463	0.637	4.613	0.515	-0.150	3.258	0.028	Private > public bank
7. IER	3.913	0.564	3.900	0.493	0.013	0.737	0.844	Public > private bank
8. WEA	3.622	0.641	3.888	0.636	-0.266	6.604	0.001	Private > public bank
Overall	3.57	0.52	3.77	0.42	-0.21	17.01	0.137	*Private > public bank

Remarks: MD = Mean Difference; SD = Standard Deviation; 95% Conf. Interval of the Difference; Sig. (2-tailed); **0.137** ($p > 0.05$) insignificant.

It has been observed from Table 7.44 that overall MD* of public bank is higher than the private bank (i.e., 3.565 < 3.772). That means, quality of working life of private

bank is better than the public bank. Mean value of child care unit (CCU) for both banks is less than those of other factors. It is being observed that working condition, ventilation, office equipment, fire extinguisher and working environment have highly effect on the employee motivation (p -value <0.05).

7.8.5 Exploratory Factor Analysis of QWL

Table 7.45: Descriptive statistics and EFA for ergonomics or QWL

Variables	Mean	SD	Test result
Workplace is congenial (WC)	3.758	0.574	KMO=0.697~70% $\chi^2=664.85$ df.=28 p -value =0.000 N=400 Extraction: PCA Data are fir for EFA
Adequate space for ventilation (AV)	3.790	0.516	
Official equipment is sophisticated (OES)	3.898	0.555	
Existing fire extinguisher (EFE)	4.320	0.518	
Child care unit (CCU)	1.010	0.158	
No Female sexual harassment(FSH)	4.493	0.617	
Internal environment affecting retention (IER)	3.910	0.550	
Work environment affecting QWL (WEA)	3.675	0.648	

The above Table 7.45 showed that there is no child care unit (CCU; mean value is 1.010) and no female sexual harassment (mean value 4.493) in the branches. The other factors' mean values are more than moderately good.

Table 7.46: EFA and total variance explained for QWL

Communalities: Ergonomics and QWL			Total Variance Explained				Remarks on highly loadings
			Initial (1.00) Eigenvalues		Extraction Sums of Squared Loadings		
Components	Initial	Extraction	Total	% of Variance	Total (>1)	% of Variance	
1. AV	1.000	0.799	2.588	32.345	2.588	32.345	Loaded by 64%
2. CCU	1.000	0.730	1.360	17.003	1.360	17.003	
3. WC	1.000	0.716	1.166	14.580	1.166	14.580	
4. IER	1.000	0.716	0.959	11.988	0.959	-	-
5. FSH	1.000	0.689	0.608	7.603	-	-	-
6. OES	1.000	0.678	0.557	6.960	-	-	-
7. WEA_QWL	1.000	0.565	0.454	5.678	-	-	-
8. FEE*	1.000	0.222	0.307	3.842	-	-	-
Only * extraction value is 0.222 <0.40 . Total variance explained and loaded covering (1+2+3) ~64% .							

Table 7.46 showed that extraction values of seven components are more than 40% the communality values from 1 to 7 out of eight factors. Communalities and extraction values are reliable to 180 analyse since values are >0.20 .^{12&13} There are three factors with Eigenvalues of adequate space, child care unit and congenial workplace are

¹² Dennis Child, *The Essentials of Factor Analysis*, 3rd edn. (New York: Continuum, 2006).

¹³ Ajai S. Gaur, and Sanjaya S. Gaur, "Researchers Commonly Use a Cut-off of 0.40 to Identify High Loadings", *Statistical Methods for Practice and Research*, 2nd edition (Response Books: New Delhi, India, 2009):143.

2.588, 1.360 and 14.580 respectively more than 1.00. That means, these three components are highly loaded and covered ~64% (32.345 +17.003+14.580) of the total variance explained. This is a sufficient for EFA in case of variance explained.^{14,15,16,&17}

Employees enjoy ensuring those facilities in the work environment affecting the QWL. These three factors are most extensive for employee motivation.

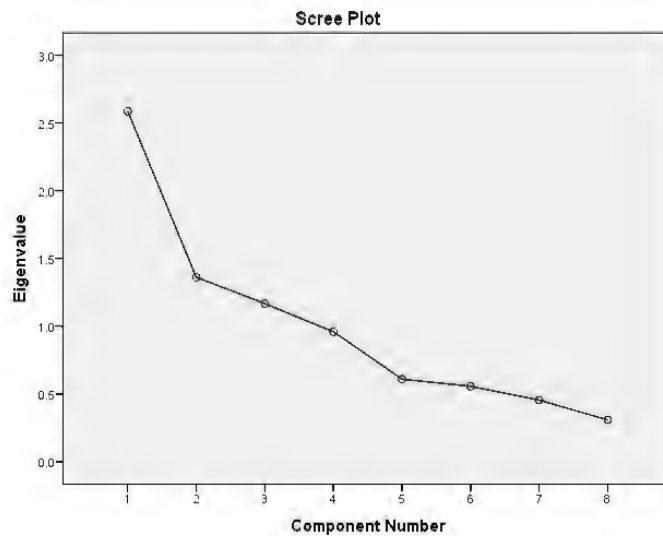

Figure 7.5 shows the scree plot of Eigenvalues and depicting two factors are forming elbow - shape and maximum proportion variance is explained in the graph. The top three communalities have been extracted i.e., adequate space, child care unit and congenial workplace are the most significant.

Figure 7.5: Scree plot of QWL

7.8.6 Exploring the Effective Factors of QWL by Applying SEM

The study has strived to find out the most effective factors involved QWL practices (considered as a latent variable) in the banking industry. In this case SEM has been applied to explore the highly effective factors that influence employee motivation (Table 7.46 and Figure 7.6).

¹⁴ Kartick Chandra Bhuyan, *Multivariate Analysis and Its Applications* (Kolkata: New Central Book Agency (P) Ltd., 2005): 151

¹⁵ Earl Babbie, *The Practice of Social Research* (California: Wardsworth Publishing Company, 1992).

¹⁶ Aandy Field, *Discovering Statistics using SPSS*, 4th edn. (London: SAGE, 2017).

¹⁷ Peter Samuels, "Advice on Exploratory Analysis Factor Analysis", *Working Paper*, 2016, <https://www.researchgate.net/publication/304490328>, DOI: 10.13140/RG.2.1.5013.9766.

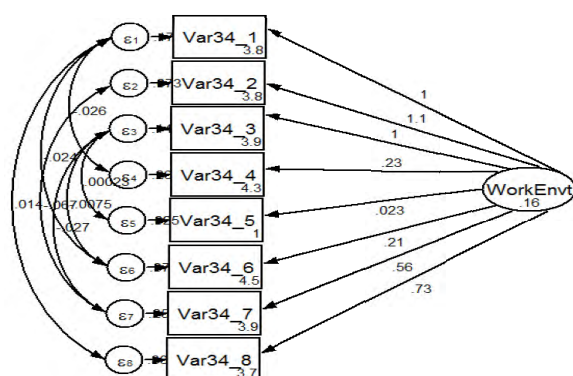

Figure 7.6: SEM for working environment

Figure 7.6 showed the SEM on workplace condition in the banks. Here, work environment is constructed as the latent factor (LF; estimated coefficient value is 0.16). The figure also states the mean values of all factors in the houses (34.1 -34.8).

Table 7.47: Measurement for SEM on QWL or work environment

Particulars (Measurement)	Coef.	Std. Err.	z	p>z	95% Conf. Interval	
QWL/ Work Environment (Latent factor)						
Var34_1 (WC)	<-					
	1	(constrained)				
_cons	3.758	0.029	131.16	0.000	3.701	3.814
Var34_2 (AV)	<-					
	1.095	0.087	12.54	0.000	0.924	1.266
_cons	3.79	0.026	147	0.000	3.739	3.841
Var34_3 (OES)	<-					
	1.021	0.086	11.86	0.000	0.852	1.189
_cons	3.898	0.028	140.71	0.000	3.843	3.952
Var34_4 (EFE)	<-					
	0.228	0.072	3.19	0.001	0.088	0.367
_cons	4.32	0.026	167.02	0.000	4.269	4.371
Var34_5 (CCU)	<-					
	0.023	0.022	1.06	0.288	-0.019	0.065
_cons	1.01	0.008	128.01	0.000	0.995	1.025
Var34_6 (FSH)	<-					
	0.209	0.088	2.38	0.017	0.037	0.381
_cons	4.493	0.031	145.76	0.000	4.432	4.552
Var34_7 (IER)	<-					
	0.558	0.113	4.94	0.000	0.337	0.780
_cons	3.91	0.028	142.36	0.000	3.856	3.964
Var34_8 (WEA)	<-					
	0.730	0.091	7.99	0.000	0.551	0.909
_cons	3.675	0.032	113.5	0.000	3.612	3.738
var(Work environment)	0.161	0.023			0.122	0.214
var(e.Var34_1)	0.167	0.017			0.137	0.204
var(e.Var34_2)	0.073	0.013			0.052	0.102
var(e.Var34_3)	0.139	0.014			0.115	0.169
var(e.Var34_4)	0.259	0.018			0.226	0.298
var(e.Var34_5)	0.026	0.002			0.022	0.029
var(e.Var34_6)	0.373	0.027			0.325	0.429
var(e.Var34_7)	0.252	0.022			0.212	0.299
var(e.Var34_8)	0.334	0.025			0.288	0.386
cov(e.Var34_4,e.Var34_1)	-0.026	0.011	-2.24	0.025	-0.048	-0.003
cov(e.Var34_6,e.Var34_1)	-0.024	0.014	-1.69	0.090	-0.052	0.004
cov(e.Var34_8,e.Var34_1)	0.014	0.014	1	0.316	-0.013	0.041
cov(e.Var34_7,e.Var34_2)	-0.067	0.015	-4.44	0.000	-0.098	-0.038
cov(e.Var34_5,e.Var34_3)	0.000	0.003	0.07	0.947	-0.007	0.007
cov(e.Var34_6,e.Var34_3)	-0.008	0.015	-0.52	0.603	-0.036	0.021
cov(e.Var34_7,e.Var34_3)	-0.028	0.017	-1.64	0.101	-0.060	0.005
Log likelihood = -1931.54; LR test: independent vs. saturated: chi2(28) = 666.53 Prob>chi2 = 0.0000						

This Table 7.47 showed information on how the SEM is specified by listing the observed variables with coefficient values of latent factor *Ergonomics or Quality of Work Life* (QWL, $\beta=0.161$) are congenial work environment ($\beta=1$ constrained), adequate ventilation ($\beta=1.095>1$), sophisticated office equipment ($\beta=1.021>1$), existing fire extinguisher ($\beta=0.228<1$), child care unit ($\beta=0.023<1$), sexual harassment ($\beta=0.209<1$), internal work environment affecting retention ($\beta=0.558<1$) and work environment affecting QWL ($\beta=0.730<1$ or near to 1). The present research has found the standardized factor loadings because the variance for *Ergonomics or QWL* has been set to 1 to scale the latent variable and for model identification. The standardized factor loading for the *sophisticated office equipment* variable and coefficient value is 1.021 which is >1 , meaning that standard deviation increases in *QWL* which leads to a 1.021 standard deviation increases in the response to the said factors effective in the model. The coefficient value of another factor that means *work environment affecting QWL* near to 1 leads the model effective. The remaining of the said five factors are the less effective factor to the model since <1 .

The model chi-square value, $\chi^2(28) = 666.53$ Prob $>\chi^2 = 0.0000$, is highly statistically significant (p -value <0.05) indicating the model reproduces the observed covariance among all factors very well. Null hypothesis (H_0) fits for the model. The p -value of 0.000 is less than .05, the typical cut-off for the test, which means that the null hypothesis is rejected and the model turns well. The p -value of child care unit-CCU is $0.228>0.05$; 95% confi. Interval between -0.019 to 0.065 observed that very few number of the bank branches have CCU. The overall model fits extremely well meaning that the latent variable specified as *QWL* strongly associated to the all factors applied to confirm the factor in this regard. The output also provides with the chi-square value of 666.53, with the degree of freedom 13, and the significance of the chi-square test (i.e. $p<0.001$). The equation may, employee motivation = f (ergonomics or QWL/work Environment).

There is an effect of ergonomics or QWL on employee motivation in the banking sector of Bangladesh. The alternative hypothesis is sustained since p -value is <0.05 . Thus, it can be concluded that the internal work environment of the bank certainly affects the satisfaction and motivation of the employees.

7.8.7 Short Findings of QWL

In the EFA there are three factors such as adequate space and ventilation, child care unit (CCU), and congenial workplace to health as highly loaded and covered by 64% variance explained. The latent factor QWL ($\beta=0.161$) practices whereas the study found that the most significant and effective factor of the QWL is adequate space & ventilation ($\beta=1.095>1$). CCU ($\beta=0.023<1$) and female sexual harassment ($\beta=0.209<1$) are observed as less effective factors. Therefore, all these factors are strongly significant effect of the latent variable. Researcher has perceived that practices of QWL of private bank (MV 3.772) is better than the public bank (MV 3.565).

7.9 Multiple Relationships among HRD Environment, Training and Retention and QWL

In this unit researcher has developed the linear relationships among the constructs of employee motivation as well (Table 7.47).

7.9.1 Test of Normality of Motivation on HRD and Work Environment for Regression Analysis

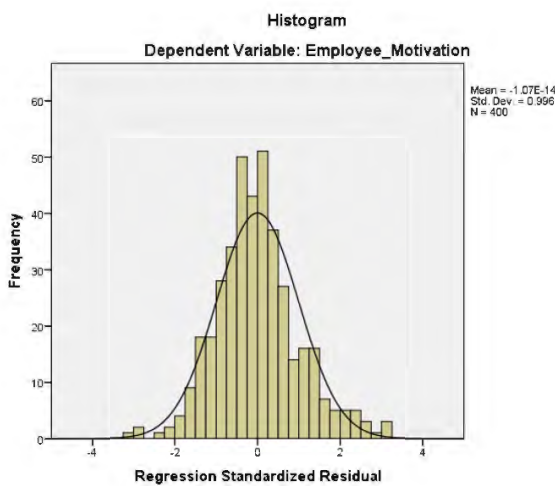

Figure 7.7: Histogram of employee motivation

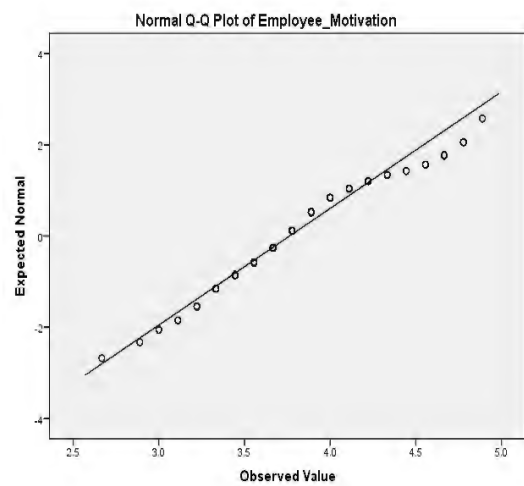

Figure 7.8: Q-Q plot of employee motivation

Table 7.48: Coefficients^a of HRD and work environment

Factors of HRD and Work Environment	Estimated Coefficients		t-statistic	Sig.	95% Confidence Interval for β		F-Statistic (p-value)
	Regression Coefficient	S.E			LB	UB	
(Constant)	1.139	0.303	3.764	0.000	0.544	1.734	26.147 (0.000)
HRD Environment (β_1)	0.140* (3)	0.071	1.962	0.050	0.000	0.280	
Training Retention (β_2)	0.372* (1)	0.075	4.978	0.000	0.225	0.518	
QWL (β_3)	0.167* (2)	0.073	2.274	0.023	0.023	0.311	
a. Dependent Variable: Employee Motivation, (b). Predictors: (Constant), HRD Environment, Training and Retention, QWL.							
c. R square ~43% , (d) Durbin-Watson 1.691 (e) Multi-correlation 0.57 ^a							

Fitted Regression Model

The fitted of the regression model as shown from the Table 7.48. It can be written as the fitted following regression model as equation form.

The fitted multiple regressions model can be written as:

$$EM = 1.139 * (\alpha) + 0.140 * HRD\ Environment + 0.372 * Training\ and\ Retention + 0.167 * QWL$$

The β_1 , β_2 , and β_3 coefficients findings are 14.5%, 37.2%, and 16.7%, (t-statistic, 1.962, 4.978, and 2.274; p-values are 0.050, 0.000, and 0.023 respectively) times positive influence of HRD environment, training and retention, and QWL on the employee motivation. The coefficients results are statistically significant p-values are < 0.05 level of significant in case of *HRD and work environment*. The p-value of the model is 0.000 (F, 26.147). Therefore, it is evident that employee motivation significantly influenced by HRD and work environment in the banks.

7.10 Discussion on Findings

From the above analysis it is evident that the level of satisfaction ensured that the HRD environment in the banking sector is favourable. The legacy or succession plan shows the most positive relationship with HRD. It has been found that existing staff have spoken positively about the work environment other than the child care unit (CCU). Also, female employees protect themselves from harassment due to strict adherence to banking laws.

Considering the HRD environment of private banks and its supportive culture, behavioural change and development, as an asset of employees, the reasons for HRP planning and development are better than the public banking sector in Bangladesh. HRD has a profound impact on staff motivation for responsibilities, HRP development, legacy planning, behavioural change training, supportive culture, and fair training and development. Therefore, HRD environment has been practiced in the banking sector of Bangladesh. In addition, it has been observed that employees wanted to get enjoyable workplace by making inheritance plans for future responsibilities and they do feel that they were considered a valuable asset. These three factors are the fundamental to the HRD environment to motivate employees in the banking sector.

Employees are being motivated to take part in rotating jobs, received feedback and eventually they would sustain themselves for a longer period of service. These three factors are the most pervasive for motivating employees in the banking sector. Both banks have appropriate training policies (PTPs).

There are three factors such as adequate space and ventilation, child care unit (CCU) and congenial workplace for health as described by the high loadings in the practices found. The latent factor practiced QWL where studies showed that the most significant and effective component of QWL is adequate space and ventilation. CCU and female sexual harassment have been observed as less effective causes. Therefore, all of these factors have a significantly more significant effect on latent variables. The researchers found that QWL's practices in private banks are better than those in public banks. Among the latent factors HRD environment, training and retention and QWL found that the most effective factor is QWL but highly correlated for employee motivation. Thus, it is cleared that employee motivation is significantly influenced by HRD and the work environment at banks.

In conclusion, many scholars have identified human resource development as the main goal of human resource management. Thus, the manpower employed in the HRD refers to their overall motivation and inclusive effort to provide the right HRD environment, as well as to develop their functional skills and abilities to achieve the expected work and behavior. In this case effective quality training is considered very important in skill development.

Chapter Eight

HRD Outcomes, HRD Climate and Employee Motivation

Background

This chapter has been divided into four sections—HRD Mechanisms, HRD Climate or OCTAPACE, Performance Appraisal, and Management Practices that covering the study objectives number seven. The objective of this chapter is to examine the effect of HRD outcomes on the employee motivation in the banks.

8.1 HRD Outcomes

HRD is concerned with an organized sequence of learning happenings, classified a specified time limit, and intended to produce behavioural change in the learner. HRD instruments and processes make people more committed and satisfied, where the employees enthusiastically continue to give their best to the organization. Nadler explicated that the term "HRD" was first applied in 1968 in George Washington University considered as pioneer. After that it is being used by American Society for Training and Development (ASTD) at Miami conference in 1969. Since 1970 the term was being used to gain more acceptances with an alternative term "Training & Development".¹

HRD matrix shows the interrelationship among HRD Mechanisms (instruments), processes, outcomes and organizational effectiveness. HRD instruments include performance appraisal (PA), communication, role analysis, training and development, job rotation, enrichment etc. HRD mechanisms lead to generate the HRD processes namely role clarity, responsibility, performance planning and development, climate risk taking, etc. HRD process confirms outcomes of the more qualified, efficient, dynamic, and satisfied, enthused and committed work force. HRD outcomes—HRD mechanisms and processes brand HRs more committed, satisfied and dedicated for which employees are enthusiastically driven to contribute their best strength to attain the banks' goal. Organizational effectiveness—HRD outcomes influence the organizational effectiveness

¹ L. Nadler, "Defining the Field - Is it HRD or OD or" *Training & Development Journal*, December 1980, Vol. 34, No.12, published by ASTD: 66.

which in turn, be determined by a number of identified variables e.g. environment, societal, updated technology and competitors. Organizational and employee outcomes have been discussed in the following 9th chapter. Dimensions of the HRD Matrix and its practices influence organizational effectiveness, which varies organizational or management practices.

8.2 HRD Instruments

These include performance appraisal, consulting, role analysis, potential development, training, communication policy, job rotation, rewards, job enhancement programs, etc. Organization can rely on the size of the organization, internal environment; support promises of policy, etc.

8.3 HRD Processes

HRD instruments lead to the HRD generation of processes such as transparency, performance planning, development climate, risk mitigation, mobility among employees. The HRD processes should result in more skilled, satisfied and committed people who will enhance the organization through their greatest contribution.

8.4 HRD Climate and Culture

For better understanding the HRD climate, organizations frequently familiarize some structured questionnaires for exploring the gap and taking corrective measures. Some of the questionnaires, could be as – (i) Does the bank consider employees as the most important resource? (ii) Does the bank believe in developing competencies of all cross-sections of employees and initiate action in that direction? (iii) Is the banking sector transparent in communication? (iv) Does the bank employees to be encouraged to take risks? (v) Is there (in the bank) a climate of collaboration, team spirit, mutual trust and confidence? (vi) To what include are HRD activities development oriented? Over these questionnaires organization could be able to find out the deviation between goals and obtained results and taking remedial actions for employee motivation as well as retention. HRD culture enables the organization to adopt with the rapid changes which are characterized by openness, confrontation, trust, autonomy, pro-activeness, authenticity, collaboration practices.

8.5 HRD Strategy

HRD integrates T & D, organizational development (OD), and career development with a view to improving individual, group and organizational effectiveness. HRD strategies believe that in order to involve employee to be successful that team effectiveness training should be delivered internally. This ensures developing employee capability and management effectiveness.

8.6 Importance of OCTAPACE in HRD Matrix

Practices of effective HRD in the organizations result in higher degree of organizational performances. Enhancement of HRD and its effective practice is likely to output increase productivity as well as reduce the employee absenteeism and turnover. HRD is a powerful tool to maximize wealth with reducing operating costs. If it is possible to apply HRD in the different organizations ensures that there could be a strong positive effect on output/outcomes. Finally employees might be highly motivated. It can be observed that HRD Climate or OCTAPACE Culture is more effective and conducive to explore and enhance better opportunities for reaching the organizational goal by confirming the potentialities of employees.

8.7 Investigation of HRD Mechanisms in the Banks

Descriptive as well as inferential statistics has been analyzed and interpreted the observation of the existing employees in the banks given below. This section of the chapter has discussed on the elements involved in the HRD mechanisms that influence HRD outcomes in the banks. The analysis has covered from Table 8.2 to 8.12.

Table 8.1: Considering HRD department in the bank as an unit (HRD_Dept)

Perception	Freq.	%	Remarks
Moderately agree	1	0.3	The survey from the aforementioned Table 8.1 found that 57.3% (maximum) of employees believe that HRD establishes the bank as a separate unit.
Agree	170	42.5	
Strongly agree	229	57.3	
Total	400	100.0	

Table 8.2: Mechanism of performance appraisal (Mecha_PA)

Perception	Freq.	%	Remarks
Moderately agree	7	1.8	Table 8.2 showed that the highest number (52.8% and 45.5%) of the respondents believe on the mechanisms of PA practices in the banking sector.
Agree	211	52.8	
Strongly agree	182	45.5	
Total	400	100.0	

Table 8.3: Review discussions, feedback, counseling and rewarding culture (RDFC)

Perception	Freq.	%	Remarks
Disagree	2	0.5	Table 8.3 showed that majority of the (54.5% and 20.8%) employees agreed that discussion and feedback are being practiced in the banks.
Moderately agree	97	24.3	
Agree	218	54.5	
Strongly agree	83	20.8	
Total	400	100.0	

Table 8.4: Manager analyzing the roles of the employees (Role_analyse)

Perception	Freq.	%	Remarks
Moderately agree	87	21.8	It has been noticed (Table 8.4) that 62% and 16.3% of the participants are agreed that the managers explored the roles of the employees.
Agree	248	62.0	
Strongly agree	65	16.3	
Total	400	100.0	

Table 8.5: Training facility making future talent development (TFCFT)

Perception	Freq.	%	Remarks
Disagree	1	0.3	From Table 8.5 the study found that 68.3% (highest) of the respondents believe that training facility makes future talent development and also for overall business.
Moderately agree	64	16.0	
Agree	273	68.3	
Strongly agree	62	15.5	
Total	400	100.0	

Table 8.6: OD Exercise and changing culture (OD & change)

Perception	Freq.	%	Remarks
Disagree	16	4.0	Researcher perceived that about 62.8% (Table 8.6) of the employees given better opinion regarding OD exercise and changing culture of organization.
Moderately agree	114	28.5	
Agree	251	62.8	
Strongly agree	19	4.8	
Total	400	100.0	

8.7.1 Observation on Correlations of the Factors of HRD Mechanisms

The study has developed a score matrix from the frequency table above and shown the correlation among the variables involved in the HRD mechanisms (Table 8.7).

Table 8.7: Score matrix of frequency and Pearson correlation HRD mechanisms in HRD matrix

HRD Mechanisms	High (A+SA)	Moderate	Correlation	p-value	Significant
HRD_Dept	399 (99%)	1 (1%)	r=1.00*	0.000	Highly significant; **Correlation is significant at 0.001 (2-tailed). r=1.00* perfect positive correlation.
PA_mecha	393 (98%)	7 (2%)	r= 0.417**	0.000	
RDFC	301 (75%)	97 (24%)	r= 0.213**	0.000	
Role_analyse	313 (78%)	87 (22%)	r= 0 .500**	0.000	
TFCFT	335 (84%)	64 (16%)	r= 0.498**	0.000	
OD & Change	270 (67%)	114 (29%)	r= 0.306**	0.000	

Observations: Table 8.7 shows r= 0.500** (highest) and p-value 0.000<0.05. The highest score of considering HRD as separate unit is 99% (agree and strongly agree)

which has the positive significant impact on employee satisfaction in the banking sector. In addition, it has also been shown that the banking industry practices HRD mechanisms applied among its employees.

8.7.2 Status of HRD Mechanisms in Public and Private Bank

The practices of HRD mechanisms in the nationalized traditional and private commercial banks are shown by using Levene’s Test for Equality Variance (Table 8.9).

Table 8.8: Comparison of HRD mechanisms between public and private bank

Factors	Public Bank		Private Bank		Levene's Test for Equality of Variances			
	Mean	SD	Mean	SD	MD	F	Sig.	Status
HRD_Dept	4.559	0.500	4.613	0.490	-0.053	3.513	0.397	Private >Public
PA_mecha	4.413	0.530	4.538	0.526	-0.125	0.012	0.060	Private >Public
RDFC	3.931	0.689	4.050	0.673	-0.119	0.120	0.166	Private >Public
Role_analyse	3.944	0.611	3.950	0.634	-0.006	0.129	0.935	Private >Public
TFCFT	3.975	0.581	4.050	0.525	-0.075	0.459	0.266	Private >Public
OD & Change	3.647	0.641	3.825	0.546	-0.178	12.379	0.013^a	Private >Public
Overall	4.078	0.592	4.171	0.566	-0.093	2.769	0.306^b	*Private >Public

Remarks: MD= Mean Difference; SD = Standard Deviation; 95% Conf. Interval of the Difference; Sig. (2-tailed). p -value **0.012^a**; $p > 0.05$ and **0.306^b**; $p < 0.05$.

Observed (Table 8.8) that mean value (public and private bank are 4.078 and 4.171 respectively) of HRD mechanisms of private bank is higher than the mean value of all factors of public bank. There is alternative hypothesis statistically significant p -value 0.013 which is than 0.05. Thus, organizational change and development has a strong impact on the HRD mechanism and employee motivation.

8.7.3 EFA of HRD Mechanisms

The factors involved in HRD mechanisms in the banks have been analysed in the Table 8.9 and Table 8.10.

Table 8.9: Descriptive and test results for EFA of HRD mechanisms

Variables: HRD Instruments	Mean	SD	Test result
HRD Department in the bank as an unit (HRD_Department)	4.570	0.501	KMO=0.674 $\chi^2=407.943$ df.=15 p -value 0.000 N=400
Mechanism of performance appraisal (PA_mechanism)	4.438	0.531	
Review discussions, feedback, counseling and rewarding culture for better performance (Review_rewarding)	3.955	0.685	
Manager analyses the roles of the employees (Role_analysis)	3.945	0.615	
Training facility creating future talent (Creating_talent)	3.990	0.571	
OD and changing culture (OD_culture)	3.683	0.627	

Extraction: Principal Component Analysis; Data are significantly suitable for EFA.

Table 8.9 shows the mean values of all the above factors of HRD mechanisms or instruments greater than 3 and 4 scale showing the practices in the banking sector is good. Bank follows performance appraisal systems (mean value 4.570) and developed a separate unit of the HRD department (4.438). The other factors of HRD instruments such as review discussion, rewarding, employees’ role analysis, creating talent and OD culture (changing culture or initiatives) are being practiced in the sampled banks.

Table 8.10: EFA and total variance explained for HRD mechanisms or sub-systems

Communalities: HRD Mechanisms			Total Variance Explained				Remarks on highly loadings
			Initial (1.00) Eigenvalues		Extraction Sums of Squared Loadings		
Components	Initial	Extraction	Total	% of Variance	Total (>1)	% of Variance	
1. Mechanism of PA	1.000	0.724	2.217	36.956	2.217	36.956	Loaded by 60%
2. HRD a unit	1.000	0.694	1.394	23.230	1.394	23.230	
3. Roles analysing	1.000	0.643	0.822	13.708	-	-	-
4. Review_rewarding	1.000	0.599	0.822	13.708	-	-	-
5. Creating talent	1.000	0.598	0.516	8.594	-	-	-
6. OD & culture*	1.000	0.353	0.466	7.763	-	-	-

*Extraction value of OD is <0.40.Total variance explained and loaded covering **60.19%** (1+2).

Table 8.10 shows that extraction values of five components are more than 40% the communality values from 1 to 5 out of six factors. There are two factors with Eigenvalues of mechanism of PA and HRD unit are 2.217 and 1.394 respectively more than 1.00. That means, these three components are highly loaded and covered ~60% (36.956 +23.230) of the total variance explained. In the HRD mechanisms or instruments performance appraisal (PA) and HRD unit factors should reevaluate in the sampled banks for employee motivation.

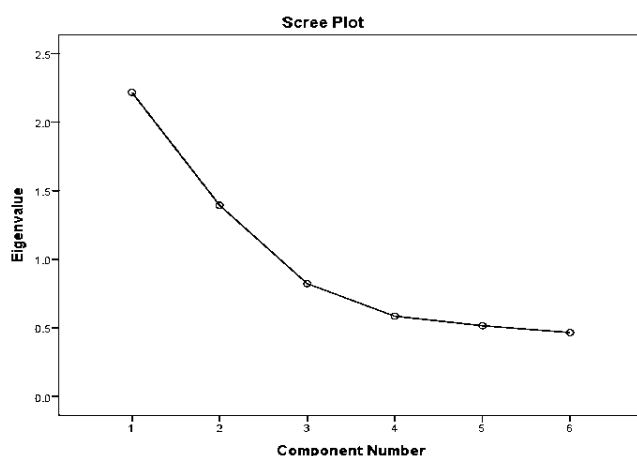

Figure 8.1 shows the scree plot of Eigenvalues and depicting two factors are creating elbow shape and maximum proportion variance explained in the graph. The top three communalities have been extracted i.e., mechanism of PA and HRD unit are the most significant.

Figure 8.1: Scree plot on HRD mechanisms

8.7.4 Measuring Effective Factors of HRD Mechanisms from SEM

Researcher has explored the effective factors significantly influence employee motivation in case of HRD mechanisms in the banking organizations by using SEM (Table 8.12 and Figure 8.2) as single latent factor.

Structural Equation Modeling for HRD Mechanisms

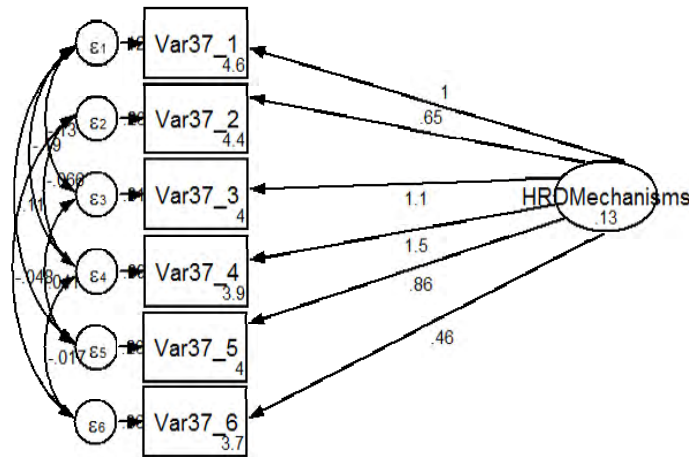

Figure 8.2 shows SEM for HRD Mechanisms (latent variable; *beta coefficient values 0.13*) with estimating coefficient paths as well as mean values of each factor (shown in 37_1 to 37_6). From this path it can be explored the effective factor of HRD instruments in motivation.

Figure 8.2: SEM on HRD instruments

Table 8.11: Measurement for SEM of HRD mechanisms

Particulars (Measurement)	Coef.	Std. Err.	z	p>z	95% Conf. Interval	
HRD Mechanisms or Sub-systems (Latent Factor)						
Var37_1(HRD_department)	<-					
	1	(constrained)				
_cons	4.57	0.025001	182.8	0.000	4.521	4.619
Var37_2 (PA_mechanism)	<-					
	0.653	17.256	0.04	0.970	-33.168	34.474
_cons	4.438	0.027	167.4	0.000	4.386	4.490
Var37_3 (Review-rewarding)	<-					
	1.104	0.248	4.45	0.000	0.618	1.590
_cons	3.955	0.034	115.63	0.000	3.888	4.022
Var37_4 (<i>Roles_analysis</i>)	<-					
	1.470	38.854	0.04	0.970	-74.683	77.623
_cons	3.945	0.030	129.5	0.000	3.885	4.005
Var37_5 (Creating_talent)	<-					
	0.863	0.194	4.44	0.000	0.482	1.244
_cons	3.99	0.029	140	0.000	3.934	4.046
Var37_6 (OD_culture)	<-					
	0.461	12.197	0.04	0.970	-23.44	24.367
_cons	3.683	0.031	117.68	0.000	3.621	3.744
var(e.Var37_1)	0.120	3.438			~0	30.6
var(e.Var37_2)	0.226	1.466			~0	76351.28
var(e.Var37_3)	0.309	4.190			~0	10.4
var(e.Var37_4)	0.090	7.431			~0	16.5
var(e.Var37_5)	0.228	2.562			~0	84
var(e.Var37_6)	0.364	0.733			0.007	18.814

var(HRD Mechanisms;LF)	0.130	3.439			~0	40.9
cov(e.Var37_1,e.Var37_3)	-0.135	3.796	-0.04	0.972	-7.574	7.304
cov(e.Var37_1,e.Var37_4)	-0.191	0.044	-4.38	0.000	-0.277	-0.106
cov(e.Var37_1,e.Var37_5)	-0.107	2.968	-0.04	0.971	-5.923	5.710
cov(e.Var37_2,e.Var37_4)	-0.066	3.300	-0.02	0.984	-6.534	6.403
cov(e.Var37_2,e.Var37_6)	-0.048	1.036	-0.05	0.963	-2.078	1.983
cov(e.Var37_3,e.Var37_5)	0.041	3.276	0.01	0.990	-6.381	6.462
cov(e.Var37_4,e.Var37_6)	-0.017	2.333	-0.01	0.994	-4.589	4.555
LR test of model vs.		saturated: chi2(2) ="34.87,"		Prob > chi2= 0.000		

This Table 8.11 showing information on how the SEM is specified by listing the observed variables with coefficient values of latent factor *HRD Mechanisms or Sub-systems* ($\beta=0.130$) are HRD department ($\beta=1$ constrained), performance appraisal mechanism ($\beta=0.653<1$), review, discussion rewarding ($\beta=1.104>1$), **role analysis** ($\beta=1.470>1$), creating talent ($\beta=0.863<1$ or considering it near to 1), and OD culture ($\beta=0.461<1$). The *p*-values for all of the factor loadings are below the typical cut-off of .05, leading to the rejection of the null hypotheses that the factor loadings are equal to 0; except *PA mechanism, role analysis and OD culture* three variables (*p*-value $0.970>0.05$, 95% interval between -33.163 to 34.474, -74.683 to 77.623 and -23.44 to 24.367 respectively) here only null hypothesis is accepted).

The standardized factors loading for the *review rewarding, and role analysis* variables and coefficient values are $\beta=1.104$ and $\beta=1.470$ which are >1 , meaning that standard deviation increases in *HRD mechanisms* lead to a standard deviation increases in the response to the said factors more effective in the model. The coefficient value of remaining one factor that means *creating talent* is near to 1 leads the model effective as well. Therefore, it is the best measure of *HRD Mechanisms or Sub-systems*. The model chi-square value, $\chi^2(2) = 34.87$ Prob>chi2 = 0.0000, is highly statistically significant (*p*-value <0.05) indicating the model reproduces the observed co-variance among all factors very well. Null hypothesis (H_0) fits in this case. The *p*-value of 0.000 is less than .05, the typical cut-off for the test, which means that the null hypothesis is rejected and the model turns well. The overall model fits extremely well meaning that the latent variable specified as *HRD Mechanisms* strongly associated to the all factors applied to measure it. The output also provides with the chi-square value of 34.87, with the degree of freedom 5, and the significance of the chi-square test (i.e. $p<0.001$). The equation may Employee Motivation = f (HRD Mechanisms or Sub-systems).

8.8 HRD Process

This unit of the chapter has discussed the HRD process and its factors. In this section frequency distribution, correlation, EFA are used to analyze the data (Table 8.13-8.20).

Table 8.12: Role clarity and clarification of norms and standards (Role clarity)

Perception	Freq.	%	Remarks
Moderately agree	24	6.0	Table 8.12 shows that 68.5% (majority) of the respondents do have faith in the norms and standards that affected by role clarity and clarification.
Agree	274	68.5	
Strongly agree	102	25.5	
Total	400	100.0	

Table 8.13: Awareness of competencies required for job performance (Aware_comptnce)

Perception	Freq.	%	Remarks
Disagree	1	0.3	Table 8.13 explains that 60.3% (highest) of the respondents' bank on that awareness of competencies required for better job performance.
Moderately agree	10	2.5	
Agree	241	60.3	
Strongly agree	148	37.0	
Total	400	100.0	

Table 8.14: Risk taking and fair rewarding culture (Risk-rewarding)

Perception	Freq.	%	Remarks
Disagree	15	3.8	From the Table 8.14 the study found that 47% (highest) of the employees do have the priority in taking risk and fair rewarding culture practices by the banking sector.
Moderately agree	74	18.5	
Agree	188	47.0	
Strongly agree	123	30.8	
Total	400	100.0	

Table 8.15: Investment on HRD (Invest_on HRD)

Perception	Freq.	%	Remarks
Strongly disagree	1	0.3	Table 8.15 shows that 68.8% (highest) of the respondents in the banks believe that banking respective bank tried to invest to develop HR.
Disagree	2	0.5	
Moderately agree	18	4.5	
Agree	275	68.8	
Strongly agree	104	26.0	
Total	400	100.0	

Table 8.16: History and past culture of employees made impartially (Past_culture)

Perception	Freq.	%	Remarks
Disagree	1	0.3	The mentioned Table the study got that 51.5% (majority) of the employees believe that past culture and history of the banking organizations affect employees' impartiality (Table 8.16).
Moderately agree	15	3.8	
Agree	178	44.5	
Strongly agree	206	51.5	
Total	400	100.0	

8.8.1 Observation on HRD Process and Its Correlation in the Banks

The relationship and perception of high degree have been shown in Table 8.18.

Table 8.17: Score matrix of frequency and pearson correlation of HRD process

HRD Process	High	Moderate	Correlation	p-value	Significant
Role clarity	376 (94%)	24 (6%)	r= 1.00*	0.000	Highly significant; **Correlation is significant at 0.001 (2-tailed). r=1.00* perfect positive correlation.
Aware_comptnce	389 (97%)	10 (3%)	r= 0.481**	0.000	
Risk_rewarding	311 (78%)	74 (19%)	r= 0.276**	0.000	
Invest_ on HRD	379 (95%)	18 (4%)	r=0 .198**	0.000	
Past_culture	384 (96%)	15 (4%)	r= 0.181**	0.000	
Overall observation: It explains that r=0.481** (highest) and p-value 0.000<0.05.					

The highest score of *awareness competence* is 97% (agree and strongly agree) which has the positive significant impact on employee motivation in the banking sector (Table 8.17). It also shown that the banking industry practices HRD process applied among its employees.

8.8.2 HRD Process and Its Ppractices in Public and Private Bank

The factors involved in the HRD process and its practices have been observed through using Levene’s Test (shown in Table 8.18).

Table 8.18: HRD process between public and private bank

Factors: HRD process	Public Bank		Private Bank		Levene's Test for Equality of Variances			
	Mean	SD	Mean	SD	MD	F	Sig.	Status
Role clarity	4.20	0.53	4.23	0.50	-0.04	0.012	0.557	Private >Public
Aware_comptnce	4.40	0.55	4.28	0.48	0.08	9.204	0.228	Public>Private
Risk_rewarding	3.80	0.85	4.35	0.48	-0.38	8.064	0.000^a	Private >Public
Invest_ on HRD	4.20	0.57	4.19	0.51	0.01	0.724	0.847	Public>Private
Past_culture	4.50	0.56	4.35	0.66	0.15	2.004	0.036^b	Public>Private
Overall	4.24	0.61	4.28	0.53	-0.03	4.00	0.334^c	*Private >Public
Remarks: MD= Mean Difference; SD = Standard Deviation; 95% Conf. Interval of the Difference; Sig. (2-tailed). The p-value 0.000^a , 0.036^b p>0.05 and 0.334^c ; p<0.05.								

It is being observed (Table 8.18) that overall * mean value (public and private bank are 4.243 and 4.278 respectively) of HRD process of private bank is slightly higher than public bank. Role clarity, risk taking and rewarding culture were being evaluated in the private bank. It has also observed that risk and rewarding culture does have a strong effect HRD process on employee satisfaction (p-value 0.000<0.05). Employees’ past history has an impact on motivation (p-value 0.036<0.05).

Table 8.19: Descriptive and test results of HRD process

HRD Process	Mean	SD	Test result
Role clarity and clarification of norms (Role clarity)	4.195	0.527	KMO=0.642 $\chi^2=193.59$ df.=10 p-value 0.000 N=400
Awareness of competencies for job (Aware_competence)	4.340	0.539	
Risk taking and fair rewarding culture (Risk & rewarding)	4.048	0.801	
Investment on HRD	4.198	0.556	
History and past culture impartially (Hist & past culture)	4.473	0.518	
Extraction Method: PCA; Significantly data suitable for EFA			

Table 8.19 showed that the mean values of all variables mentioned above of the HRD process are >4 scale. That means, the HRD process involved in HRD Matrix and its practices in the banking sector is extent or true.

Table 8.20: EFA and total variance explained on HRD process

Communalities: HRD Process			Total Variance Explained				Remarks on loadings
			Initial (1.00) Eigenvalues		Extraction Sums of Squared Loadings		
Components	Initial	Extraction	Total	% of Variance	Total (>1)	% of Variance	
1. Role clarity	1.000	0.565	1.88	37.686	1.88	37.70%	Loaded
2. Competence	1.000	0.548	0.96	19.275	-	-	-
3. Risk & rewarding	1.000	0.415	0.91	18.166	-	-	-
4. Invest_HRD*	1.000	0.187	0.74	14.853	-	-	-
5. Hist & past culture**	1.000	0.170	0.50	10.020	-	-	-
***Extraction values are <0.40. ² Factor extraction value at 0.40 is supportive to high loadings. Total variance explained and loaded covering by 38% (1).							

Table 8.20 shows that extraction values of three components are more than 40% the communality values from 1 to 3 out of five factors. There is only one factor with Eigenvalue's of role clarity 1.884 more than 1.00. That means, these three components are highly loaded and covered ~38% of the total variance explained. In the HRD process role clarity is varied in the sampled banks. History and past culture, and investment on HRD are highly practices in the banking sector. The Eigenvalues of the two factors such as awareness and competence building and risk taking and rewarding are 0.964 and 0.908 respectively which are near to initial value These two factors are varied as well.

² Ajai S. Gaur and Sanjaya S. Gaur, *Statistical Methods for Practice and Research*, 2nd edn (New Delhi: Response Books, 2009):143.

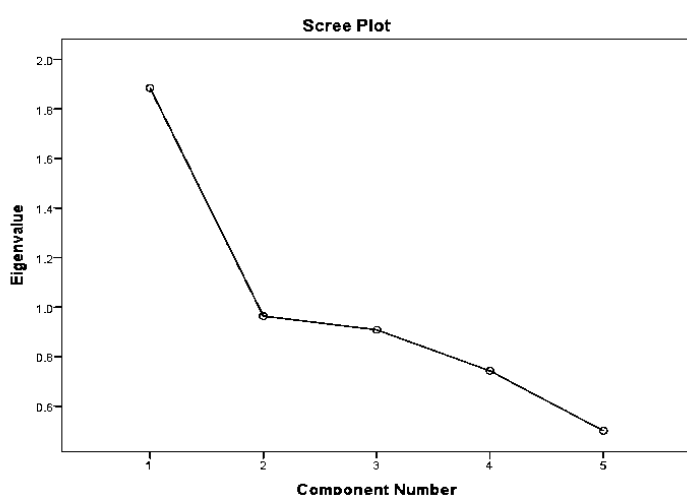

Figure 8.3 shows the scree and component plot of Eigenvalues and depicting two factors are constructing elbow-shaped and maximum proportion variance is explained in the graph. The top two communalities have been extracted i.e., role clarity and awareness competence of the employees are the most significant.

Figure 8.3: Scree plot on HRD process

8.9 OCTAPACE or HRD Climate Variables or Eight Culture

Discussion on the HRD climate or culture practices in the banking sector of Bangladesh is given below (Table 8.21 to Table 8.36).

Table 8.21: Openness (O) personality for various curiosities

Perception	Freq.	%	Remarks
Disagree	1	0.3	Table 8.21 explains that 71.5% of the respondents believe that banking sector is being tried to create the environment through openness culture among employees.
Moderately agree	53	13.3	
Agree	286	71.5	
Strongly agree	60	15.0	
Total	400	100.0	

Table 8.22: Confrontation (C) (bringing employee face to face for role efficiency, satisfaction, and attitude towards work)

Perception	Freq.	%	Remarks
Disagree	1	0.3	Table 8.22 shows that highest (65.8% and 23%) number of the respondents brought face to face for increasing efficiency, satisfaction and positive attitudes towards job.
Moderately agree	44	11.0	
Agree	263	65.8	
Strongly agree	92	23.0	
Total	400	100.0	

Table 8.23: Trust (T) among colleagues through better communication

Perception	Freq.	%	Remarks
Strongly disagree	3	0.8	It is evident (Table 8.23) that majority of the participants believe that trust among colleagues increased better understanding for doing a job better.
Disagree	1	0.3	
Moderately agree	27	6.8	
Agree	195	48.8	
Strongly agree	174	43.5	
Total	400	100.0	

Table 8.24: Autonomy (A)

Perception	Freq.	%	Remarks
Strongly disagree	63	15.8	For doing respective job only employees have given autonomy. About 40.3% more of the employees were moderately agreed regarding job autonomy (Table 8.24).
Disagree	119	29.8	
Moderately agree	161	40.3	
Agree	43	10.8	
Strongly agree	14	3.5	
Total	400	100.0	

Table 8.25: Proactive orientation is given by the bank (P)

Perception	Freq.	%	Remarks
Disagree	6	1.5	Table 8.25 shows that majority (50% and 46.8%) number of the employees replied positively regarding the proactive orientation.
Moderately agree	7	1.8	
Agree	200	50.0	
Strongly agree	187	46.8	
Total	400	100.0	

Table 8.26: Authenticity (A) and accountability in the security and fact

Perception	Freq.	%	Remarks
Moderately agree	4	1.0	Table 8.26 shows 69.8% (highest) of the respondents do have strong beliefs on the authenticity and accountability in terms of security and fact of the banks.
Agree	117	29.3	
Strongly agree	279	69.8	
Total	400	100.0	

Table 8.27: Collaboration (C) or work together with others (cooperation)

Perception	Freq.	%	Remarks
Disagree	16	4.0	From Table 8.27 the researcher found that 43.5% (highest number) of the participants given positive thinking about collaboration with employees.
Moderately agree	102	25.5	
Agree	174	43.5	
Strongly agree	108	27.0	
Total	400	100.0	

Table 8.28: Experimentation (E) for new projects and things

Perception	Freq.	%	Remarks
Strongly disagree	1	0.3	Table 8.28 shows that 52.5% (highest) of the employees are being engaged in different projects with experimentation and took pilot projects.
Disagree	4	1.0	
Moderately agree	28	7.0	
Agree	210	52.5	
Strongly agree	157	39.3	
Total	400	100.0	

8.9.1 Overall Score and Correlation Matrix of OCTAPACE

This section has explained the aggregate frequencies and correlations among the factors HRD climate (Table 8.29).

Table 8.29: Score matrix of frequency and correlation OCTAPACE/HRD climate

OCTAPACE	High	Moderate	Correlation	p-value	Significant
Openness (O)	346 (87%)	53 (13%)	r= 1.00*	0.000	Strongly significant; **Correlation is significant at 0.001 (2-tailed). r=1.00* perfect positive correlation. Thus, HRD climate variables are practiced in the banking sector.
Confrontation (C)	355 (89%)	44 (11%)	r= 0.505**	0.000	
Trust (T)	369 (92%)	27 (7%)	r= 0.407**	0.000	
Autonomy (A)	57 (14%)	161 (40%)	r= 0.167**	0.000	
Proactiveness (P)	387 (97%)	7 (2%)	r= 0.293**	0.000	
Authenticity (A)	396 (99%)	4 (1%)	r= 0.293**	0.000	
Collaboration (C)	282 (71%)	102 (25%)	r= 0.262**	0.000	
Experimentation (E)	367 (92%)	28 (7%)	r= 0.202**	0.000	
Observations: It shows r = .505 ** (maximum in confrontation) and p-value 0.000 <0.05. High Level perception (Agree+ Strongly Agree) in OCTAPACE or HRD Climate variables.					

From the Table 8.29 the highest score 99% of authenticity (agree and strongly agree) which does have a significant positive impact on employee motivation in the banking sector. Moreover, it further showed that the banking industry practices OCTAPACE applied among its employees. Almost all the perception values are higher than 50% except 14% of autonomy.

8.9.2 HRD Climate Practices between Public and Private Bank

Researcher has strived to show the practices of OCTAPACE culture comparatively between the banks in Table 8.30.

Table 8.30: HRD climate or OCTAPACE between public and private bank

Factors: OCTAPACE	Public Bank		Private Bank		Levene's Test for Equality of Variances			
	Mean	SD	Mean	SD	MD	F	Sig.	Status
Openness	4.01	0.56	4.04	0.46	-0.03	1.53	0.645	Private>Public
Confrontation	4.11	0.58	4.13	0.58	-0.01	0.04	0.864	Private >Public
Trust	4.34	0.70	4.34	0.59	0.001	1.45	0.971	Public>Private
Autonomy	2.56	0.99	2.58	0.98	-0.01	0.29	0.920	Private >Public
Proactiveness	4.44	0.60	4.33	0.63	0.12	0.01	0.118	Public>Private
Authenticity	4.69	0.49	4.68	0.47	0.02	0.02	0.080	Public>Private
Collaboration	3.85	0.85	4.26	0.65	-0.41	4.71	0.000^a	Private >Public
Experimentation	4.25	0.68	4.46	0.57	-0.21	0.04	0.011^b	Private >Public
Overall	4.03	0.68	4.10	0.62	-0.07	1.01	0.451^c	*Private>Public
Remarks: MD = Mean Difference; SD = Standard Deviation; 95% Conf. Interval of the Difference; Sig. (2-tailed). The observed p-value 0.000^a , and 0.011^b p>0.05 and 0.451^c ; p<0.05.								

Overall * mean value (public and private bank are 4.034 and 4.100 respectively) of HRD climate of private bank is slightly higher than public bank. That means, HRD climate or OCTAPACE culture or (eight variables) practices are being observed in the private bank rather than public bank (Table 8.30). Trust, proactiveness, authenticity, collaboration and experimentation are highly practices in the public bank than the private bank. Job autonomy practices in both the banks showing dissatisfaction among

the employees. It has being observed that employees agreed with HRD climate practices in the public and private banking sector of Bangladesh. Collaboration and experimentation have the statistically significant impact on employee motivation in case OCTAPACE in the banking sector since p -value < 0.05 ($p=0.000$ and $p=0.011$).

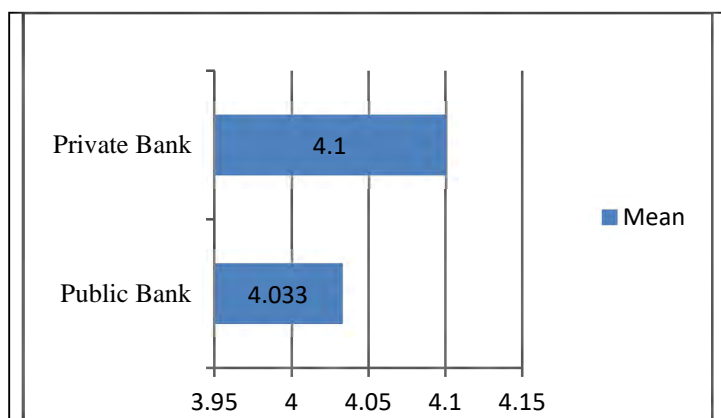

Figure 8.4 depicts the mean values of the public and private banks in case of OCTAPACE is being used in the employee development. It shows that the private bank comparatively better than public bank.

Figure 8.4: OCTAPACE in public and private bank

8.9.3 Perception of Officers and Principal Officers on OCTAPACE

HRD culture or OCTAPACE practices in the banking sectors and its perception of officer and PO level has been examined that is shown in Table 8.31.

Table 8.31: Perception of OCTAPACE among Officers and POs

Eight culture	Officer		PO		Levene's Test for Equality of Variances			
	Mean	SD	Mean	SD	MD	F	Sig.	Motivation
Openness	3.91	0.59	4.098	0.515	-0.193	0.667	0.415	PO >Officer
Confrontation	4.06	0.62	4.109	0.523	-0.046	0.522	0.471	PO >Officer
Trust	4.26	0.66	4.304	0.752	-0.041	0.260	0.611	PO >Officer
Autonomy	2.34	0.92	2.674	0.927	-0.337	0.162	0.688	PO >Officer
Proactiveness	4.37	0.57	4.391	0.628	-0.023	0.818	0.367	PO >Officer
Authenticity	4.67	0.47	4.707	0.504	-0.033	0.147	0.702	PO >Officer
Collaboration	3.85	0.85	4.065	0.887	-0.213	0.110	0.741	PO >Officer
Experimentation	4.22	0.66	4.294	0.688	-0.072	1.779	0.184	PO >Officer
Grand output	3.96	0.67	4.080	0.678	-0.120	0.558	0.522	PO >Officer

In the Table 8.31 it is being observed that overall p -value > 0.05 ; There is insignificant relationship between officer and principal officer in terms of OCTAPACE culture in the sampled banks. Here is to be noted that PO is more satisfied/motivated than the officer since mean value shows $MD_{PO} > MD_{Officer}$ (-0.12).

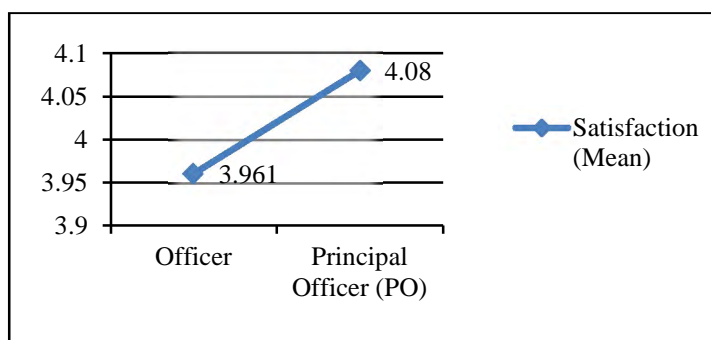

Figure 8.5 shows the mean difference between officer and principal officer. It is being observed that entry level officers are less satisfied than the PO.

Figure 8.5: OCAPACE among Os and POs in banks

8.9.4 Factor Analysis of HRD Climate Components

Factors included in HRD climate have analysed in Table 8.32 and 8.33.

Table 8.32: EFA for HRD climate or OCTOPACE

Variables: HRD with OCTOPACE	Mean	SD	Test result
Openness personality for various curiosity (O)	4.013	0.541	KMO=0.70 $\chi^2=414.651$ df.=28 p-value=0.000 N=400
Confrontation (C)	4.115	0.581	
Trust among colleagues (T)	4.340	0.682	
Autonomy (A)	2.565	0.994	
Proactive orientation is given by the bank (P)	4.420	0.608	
Authenticity and accountability with fact (A)	4.688	0.485	
Collaboration or work together with others (C)	3.935	0.826	
Experimentation for new projects and things (E)	4.295	0.663	
Extraction Method: Principal Component Analysis; Remarks: Significantly data are good fit.			

Table 8.32 shows that the mean values of all factors of OCTAPACE of the HRD climate are greater 4 scale (true degree) except autonomy (mean value 2.565<3). Therefore, the practices of HRD climate or 8 cultures (OCTAPACE) in the sector show the good figure.

Table 8.33: Total variance explained of HRD with OCTOPACE

Communalities: HRD with OCTOPACE			Total Variance Explained				Remarks
			Initial (1.00) Eigenvalues		Extraction Sums of Squared Loadings		
Components	Initial	Extraction	Total	% of Variance	Total (>1)	% of Variance	
1. Confrontation (C)	1.000	0.608	2.326	29.079	2.326	29.079	Loaded by 47%
2. Openness (O)	1.000	0.588	1.401	17.510	1.401	17.510	
3.Trust (T)	1.000	0.512	0.989	12.368	-	-	-
4. Authenticity (A)	1.000	0.509	0.846	10.573	-	-	-
5. Autonomy (A)	1.000	0.467	0.701	8.760	-	-	-
6. Proactive (P)	1.000	0.439	0.677	8.468	-	-	-
7. Collaboration (C)	1.000	0.436	0.629	7.861	-	-	-
8. Experimntn(E)*	1.000	0.169	0.430	5.380	-	-	-
Total variance explained loaded covering (1+2) ~47% . *Extraction value of experimentation (E) for new projects is less than 0.40.							

Table 8.33 shows that extraction values of seven components are more than 40% the communality values from 1 to 7 out of eight factors. There are two factors with Eigenvalues of confrontation-C and openness-O are 2.326 and 1.401 respectively more than 1.00. That means, these two components are highly loaded and covered ~47% (29.079 +17.510) of the total variance explained. Since the said two variables are varied this is why, it should review by sampled banks.

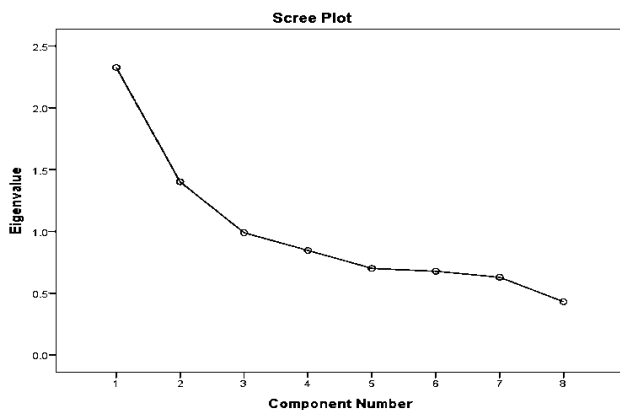

Figure 8.6: Scree plot OCTAPACE in banks

Figure 8.6 shows the scree plot of Eigenvalues depicting two factors are creating elbow shape and maximum proportion variance is explained in the graph. The top three extracted i.e., confrontation and openness personality of HRD climate are the most substantial factors for employee motivation.

8.9.5 Effective Factors of HRD Climate

This section of the chapter explored the most and significant factors included in the latent variable OCTAPACE with HRD process influencing employee motivation of the banking organization (Table 8.34-8.35, and Figure 8.7).

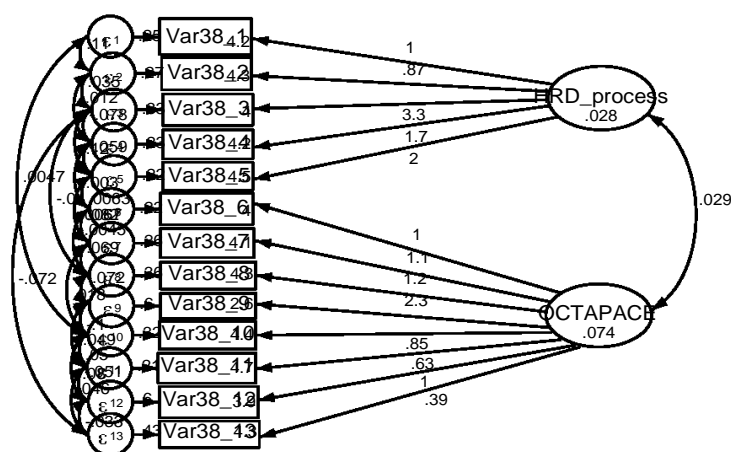

Figure 8.7: SEM on HRD process and OCTAPACE

Figure 8.7 showing SEM on HRD process (Latent factor 1; $\beta = .028$) and HRD climate or OCTAPACE (Latent factor 2; $\beta = .074$) in the significant part of the HRD matrix. The figure shows the mean values of all variables.

Table 8.34: Measurement for SEM on HRD process and HRD climate

Particulars (Measurement)	Coef.	S.E	z	p>z	95% Conf. Interval	
HRD Process (Latent 1) and HRD Climate (Latent 2) or OCTAPACE						
Var38_1 (Roles clarity & norms)	<-					
	1	(constrained)				
_cons	4.20	0.026	159.4	0.000	4.143	4.247
Var38_2 (Awareness & performance)	<-					
	0.87	0.278	3.14	0.002	0.328	1.418
_cons	4.34	0.027	161.56	0.000	4.287	4.3393
Var38_3 (Risk & fair rewarding)	<-					
	3.33	1.212	2.75	0.006	0.953	5.701
_cons	4.05	0.040	101.2	0.000	3.969	4.126
Var38_4 (Investment on HRD)	<-					
	1.70	0.636	2.67	0.008	0.451	2.945
_cons	4.20	0.028	151.3	0.000	4.143	4.252
Var38_5 (History & past)	<-					
	2.01	0.772	2.61	0.009	0.500	3.525
_cons	4.47	0.029	153.6	0.000	4.415	4.530
HRD Climate or OCTAPACE (Latent factor 2)						
Var38_6 (Openness)	<-					
	1	(constrained)				
_cons	4.01	0.027	148.4	0.000	3.959	4.065
Var38_7 (Confrontation)	<-					
	1.05	0.138	7.63	0.000	.782	1.323
_cons	4.12	0.029	141.8	0.000	4.058	4.172
Var38_8 ((Trust)	<-					
	1.18	0.231	5.13	0.000	0.731	1.637
_cons	4.34	0.034	127.4	0.000	4.273	4.407
Var38_9 (Autonomy)	<-					
	2.28	0.389	5.87	0.000	1.521	3.046
_cons	2.57	0.050	51.81	0.000	2.468	2.662
Var38_10 (Proactive)	<-					
	0.85	0.197	4.30	0.000	0.461	1.233
_cons	4.42	0.030	145.6	0.000	4.360	4.480
Var38_11 (Authenticity)	<-					
	0.63	0.155	4.04	0.000	0.322	0.929
_cons	4.69	0.024	193.39	0.000	4.640	4.735
Var38_12 (Collaboration)	<-					
	1.03	0.223	4.59	0.000	0.588	1.464
_cons	3.94	0.041	95.35	0.000	3.854	4.016
Var38_13 (Experimentation)	<-					
	0.39	0.156	2.53	0.012	0.088	0.698
_cons	4.30	0.033	129.9	0.000	4.230	4.360
Var(HRD process)	0.393	0.013			0.011	0.071
Var(OCTAPACE or HRD climate)	0.074	0.019			0.045	0.121
var(e.Var38_1)	0.249	0.020			0.212	0.292
var(e.Var38_2)	0.267	0.020			0.231	0.309
var(e.Var38_3)	0.325	0.111			0.167	0.634
var(e.Var38_4)	0.224	0.045			0.167	0.307
var(e.Var38_5)	0.218	0.020			0.151	0.333
var(e.Var38_6)	0.255	0.023			0.183	0.261
var(e.Var38_7)	0.360	0.036			0.297	0.439
var(e.Var38_8)	0.595	0.073			0.468	0.756
var(e.Var38_9)	0.316	0.026			0.268	0.372
var(e.Var38_10)	0.206	0.017			0.176	0.241
var(e.Var38_11)	0.604	0.047			0.519	0.702

var(e.Var38_12)	0.426	0.040			0.370	0.489
var(e.Var38_13)						
cov(e.Var38_2,e.Var38_1)	0.111	0.015	7.43	0.000	0.081	0.140
cov(e.Var38_10,e.Var38_1)	0.008	0.014	0.34	0.731	-0.022	0.032
cov(e.Var38_3,e.Var38_2)	0.035	0.027	1.28	0.199	-0.018	0.088
cov(e.Var38_4,e.Var38_2)	-0.012	0.016	-0.74	0.456	-0.043	0.020
cov(e.Var38_4,e.Var38_3)	-0.078	0.054	-1.44	0.150	-0.184	0.028
cov(e.Var38_5,e.Var38_3)	-0.117	0.060	-1.96	0.05	-0.089	0.009
cov(e.Var38_8,e.Var38_3)	-0.040	0.025	-1.60	0.111	-0.089	0.009
cov(e.Var38_13,e.Var38_3)	-0.072	0.024	-2.97	0.003	-0.120	-0.025
cov(e.Var38_5,e.Var38_4)	-0.059	0.034	-1.76	0.078	-0.120	0.007
cov(e.Var38_6,e.Var38_4)	-0.003	0.013	-0.24	0.814	-0.028	0.022
cov(e.Var38_6,e.Var38_5)	0.006	0.015	0.42	0.674	-0.023	0.036
cov(e.Var38_7,e.Var38_5)	0.006	0.015	0.38	0.704	-0.024	0.035
cov(e.Var38_7,e.Var38_6)	0.082	0.017	4.86	0.000	0.049	0.115
cov(e.Var38_8,e.Var38_6)	-0.004	0.020	-0.23	0.821	-0.043	0.034
cov(e.Var38_8,e.Var38_7)	0.069	0.021	3.21	0.001	0.027	0.110
cov(e.Var38_10,e.Var38_7)	0.018	0.014	1.23	0.220	-0.010	0.046
cov(e.Var38_9,e.Var38_8)	-0.072	0.038	-1.91	0.056	-0.145	-0.020
cov(e.Var38_10,e.Var38_9)	-0.104	0.032	-3.30	0.001	-0.166	-0.042
cov(e.Var38_11,e.Var38_9)	-0.049	0.025	-2.00	0.046	-0.097	-0.001
cov(e.Var38_11,e.Var38_10)	0.050	0.015	3.26	0.001	0.020	0.080
cov(e.Var38_12,e.Var38_10)	-0.080	0.025	-3.21	0.001	-0.129	-0.031
cov(e.Var38_12,e.Var38_11)	-0.051	0.020	-2.60	0.009	-0.090	-0.013
cov(e.Var38_13,e.Var38_11)	0.046	0.016	2.92	0.003	0.015	0.076
cov(e.Var38_13,e.Var38_12)	-0.032	0.027	-1.23	0.220	-0.085	0.020
cov(OCTAPACE_HRD process)	0.029	0.012	2.42	0.016	0.006	0.053
Log likelihood = -4722.3554; (1) [Var38_1] HRD_process = 1; (2) [Var38_6]OCTAPACE = 1, LR test of model vs. saturated: chi2(64) = 274.18, Prob > chi2 = 0.0000; Obs= 400; ml.						

The Table 8.34 gives information about how the model is specified by listing the observed variables mentioning with coefficient values of the *HRD process* ($\beta=0.393$) and *HRD Climate or OCTAPACE* ($\beta=0.074$) as two latent variables) respectively are role clarity & norms ($\beta=1$, constrained), awareness performance ($\beta=0.873$), risk taking & fair rewarding ($\beta=3.327>1$), investment on HRD ($\beta=1.698>1$), history & past culture ($\beta=2.013>1$), and the latent variable (*HRD Process*). Similarly, the table shows information on how the model is specified by listing the observed variables with coefficient values of the latent variable (OCTAPACE) are openness-O ($\beta=1$, constrained), confrontation-C ($\beta=1.052>1$), trust-T ($\beta=1.184>1$), autonomy-A ($\beta=2.283>1$), proactiveness-P ($\beta=0.847$ near to 1), authenticity & accountability-A ($\beta=0.626$), collaboration or cooperation-C ($\beta=1.026>1$), and experimentation-E ($\beta=0.393$). Among these variables risk taking and fair rewarding ($\beta=3.327>1$) along with autonomy ($\beta=2.283>1$) are the highly effective factors.

The study observed the standardized factor loadings because of the variance for *HRD process* has been set to 1 to scale the latent variable and for model identification. The standardized factor loading for the *risk taking & fair rewarding, history & past*

culture and investment on HRD variables are >1.00 meaning that standard deviation increased in HRD Process leads to a 3.327, 2.013, and 1.698 standard deviation increased in the response to these said three factors in the model. The remaining all other factors are the strongest factor loading of the latent factor HRD Process since the coefficient values are near to 1; therefore, it is the best measure of HRD Process fits.

Similarly, the standardized factor loadings because the variance for OCTAPACE has been set to 1 to scale the latent variable and for model identification. The standardized factor loading for the autonomy-A, trust-C, confrontation-C and collaboration-C variables are >1 meaning that standard deviation increased in these four factors leading to 2.283, 1.183, 1.052 and 1.026 respectively standard deviation increases in the response to the HRD Climate or OCTAPACE in the model. The test statistic value extremely significant (p -value=0.000<0.05) at 5% level of significance.

With all of the model level fit measures taken together, the overall model fits extremely well meaning that the latent variable specified as HRD process and HRD Climate or OCTAPACE are strongly related to the all factors used to quantity it. The output also provides with the chi-square value of 274.18, with the degree of freedom 38, and the significance of the chi-square test (i.e. $p < 0.001$). Therefore, the equation is EM = f (HRD Process + HRD Climate or OCTAPACE).

Hypothesis (H_a): There is a direct association between motivation and HRD process and OCTAPACE

Table 8.35: Results of path coefficients of HRD mechanism, process and OCTAPACE

Hypothesized Structural Path	<i>p</i> -value	Coef.	Relationship	Effect
Motivation<- HRD Mechanisms	0.485	0.130	H_{a1} ; rejected	Indirect
Motivation<- HRD Process	0.000	0.393	H_{a1} ; accepted	Direct
Motivation<- OCTAPACE	0.000	0.074	H_{a2} ; accepted	Direct
Motivation<-HRD, Mech, Proccs , OCTAPACE	0.000	0.597	H_{a3} ; accepted	Direct

Therefore, it is being observed that all null hypotheses are rejected and alternative hypotheses are supported this is why there is a direct effect of HRD process and OCTAPACE on employee motivation of the sampled banks. It has also been observed that *Beta coefficient* value of HRD process is higher than OCTAPACE. HRD mechanisms affect employee productivity and motivation indirectly (Table 8.35).

8.10 Performance Appraisal Practices in the Banks

The appraisal system has motivational effects on employees. Employees' performance appraisal (PA) is a process of confirming whether the employees are doing their assigned tasks appropriately. PA system gears up initiatives, develops a sense of responsibility and increase employees' efforts toward achieving personal and organizational goal. Through this way, their motivation to improve their current performance increases when the feedback is given.

This section aimed at examining and extracting the most effective factors of performance appraisal (PA) on motivation through a survey of randomly selected on 400 employees in the banking sector of Bangladesh. Employees' motivation depends on the feedback at job responsibilities. PA affects the employee behavior. Promotion, career development, productivity, fair rewards, incentives, etc. are the factors of motivation.

8.10.1 Required for Performance Appraisal of the Bank Employee

Employee performance may be defined as a process of verifying whether the employee is doing the assigned tasks and responsibilities appropriately. Employees are appointed to perform some specific duties and responsibilities, and their performance is evaluated with standards of work so as to determine how 'good' or bad their performance. Performance appraisal is also regarded as performance review, employee appraisal, performance evaluation, employee evaluation, merit evaluation and rating, efficiency rating, service rating.

Human resources are the most valuable assets and they are the main means of improving productivity. It is the high time for HR managers to realize that effectiveness of the HRD functions does have an extensive impact on the front-line performance of the firms.³ The appraisal system does have motivational effect on employees' behavior. Employees' performance appraisal (PA), a process of confirming whether the employee is doing his/her assigned tasks appropriately. PA system gears up initiatives, develops a sense of responsibility and increase employees' efforts toward achieving personal and

³ Ricky W. Griffin, *Management*, 8th edition (NY: Houghton-Mifflin, 2006): 438.

organizational goal.⁴ Through this way, their motivation to improve their current performance increases when the feedback is given. The direct relationship between performance and motivation can be defined through using a formula⁵: $P = f(A \times M)$; whereas, P= performance, A= Ability, and M=Motivation. If the level of motivation is low, the extent of the job performance of the employees will also be low, vice-versa. If motivation level is low results fatigue, sleepiness, emotional excitement increases reducing job performance.⁶ When motivation level is high jobs are given more attention, all other related factors escape the attention of that person.⁷ Actually, PAS shows the performance behavior of existing employees. In this case studies reported that the employee and employer were frustrated.⁸ But presently many contemporary corporations have recognized significantly those performance management systems as a means of developing higher levels of productivity.⁹

8.10.2 Performance Appraisal (PA) and Motivation

This section includes employee performance evaluation techniques such as MBO, mechanism of rewarding for best performers without bias, due time promotion, considering seniority and performance based upgradation, assessing the higher productivity and demotion for lower output of assigned employees (Table 8.36-8.45).

Table 8.36: PA report is made based on management by objective (MBO)

Perception	Freq.	%	Remarks
Sometimes	1	0.3	Table 8.36 explains that 61.3% (highest) of the employees stated that HR Department evaluated the individual performance based on MBO or specification of unit target.
Often	2	0.5	
Very often	245	61.3	
Always	152	38.0	
Total	400	100.0	

⁴ M. Omar Ali, *Essentials of Human Resource Management*, 1st edn. (Rajshahi, 2009): 152-172.

⁵ R. Maier, *Psychology in Industry*, 2nd edn. (Boston: Houghton-Mifflin, 1955). And Norman RF Maier, and L. Richard Hoffman, "Organization and creative problem solving," *Journal of Applied Psychology* 45, no. 4 (1961): 277.

⁶ John William Atkinson, "Strength of Motivation and Efficiency of Performance. In Atkinson and Raynor JO (Eds)", *Motivation and Achievement*, Washington, D.C.: Winston & Sons. (1974, h).

⁷ Victor .H. Vroom, *Work and Motivation* (New York, 1964).

⁸ Karlien Scholtz, *The Importance of Performance Appraisals*, 2013. www.Laborwise.co.za/laborbytes/performance-appraisals.

⁹ Jamie A. Gruman, and Alan M. Saks, "Performance management and employee engagement", *Human Resource Management Review*, 21 (2):123-276.

Table 8.37: Mechanisms to reward any good work done by employees fairly

Perception	Freq.	%	Remarks
Sometimes	8	2.0	Table 8.37 describes that majority (73.3%) of the participants truly agreed that employees are rewarded for good performance fairly.
Often	15	3.8	
Very often	293	73.3	
Always	84	21.0	
Total	400	100.0	

Table 8.38: Employees are being promoted on time

Perception	Freq.	%	Remarks
Never	12	3.0	Table 8.38 elucidates 35.5% employees stated that they are often promoted on time, 26.3% were upgradated very often. It has been observed that a variation in giving promotion on time.
Sometimes	127	31.8	
Often	142	35.5	
Very often	105	26.3	
Always	14	3.5	
Total	400	100.0	

Table 8.39: Employees are being promoted based on seniority

Perception	Freq.	%	Remarks
Never	1	0.3	Table 8.39 shows that 59.8% employees stated that the authority prioritized to promote based on seniority as well.
Sometimes	8	2.0	
Often	54	13.5	
Very often	239	59.8	
Always	98	24.5	
Total	400	100.0	

Table 8.40: Employees are promoted based on performance

Perception	Freq.	%	Remarks
Never	1	0.3	Table 8.40 describes that majority (28.5%, 54% and 14.8%) of the participants agreed that they are being promoted based performance.
Sometimes	10	2.5	
Often	114	28.5	
Very often	216	54.0	
Always	59	14.8	
Total	400	100.0	

Table 8.41: Higher productivity is evaluated by the authority

Perception	Freq.	%	Remarks
Sometimes	7	1.8	Table 8.41 clarifies that 53% (highest) of the respondents agreed positively that higher output or productivity evaluated by the authority concerned.
Often	116	29.0	
Very often	212	53.0	
Always	65	16.3	
Total	400	100.0	

Table 8.42: Lower output of employees giving demotion/ transfer

Perception	Freq.	%	Remarks
Sometimes	11	2.8	Table 8.42 spells out that the majority (54%) of the employees approved that they have been given punishment due to lower output.
Often	99	24.8	
Very often	216	54.0	
Always	74	18.5	
Total	400	100.0	

8.10.3 Bivariate Analysis and Correlation of Performance Appraisal

Table 8.43: Matrix of freq. and bivariate correlation on PA *crosstabs by nature of bank

Factors & Scale: (freq. in %)	Pearson Correlation and Chi ² p-value	
	$\alpha=0.01$ ** $\alpha=0.05$ * (2-tailed)	Observation and decision
Very often (4) and always (5)		
PA is reported based on MBO (MBO: 99.3%)	$r=1$ (cons) p -value 0.000; $<\alpha$ H_{01} rejected	Significantly MBO influencing employee motivation in the banks.
Mechanisms of fair rewarding for good work (Reward: 94.3%)	$r=0.288$ ** p -value 0.000; $<\alpha$ H_{02} rejected	Employees' motivation is highly related to fair rewarding based on PA.
Employees are being promoted on time (Timely Promo: 29.8%)	$r=0.149$ ** p -value 0.007; $<\alpha$ H_{03} rejected	On time promotion is significantly associated to employee motivation.
Employees are being promoted based on seniority (Sr_Promo: 84.3%)	$r=0.147$ ** p -value 0.054; $<\alpha$ H_{04} rejected	Promotion based on seniority is significantly affecting employee motivation.
Promotion based on performance (Promo_performance: 68.8%)	$r=0.120$ * p -value 0.000; $<\alpha$ H_{05} rejected	There is a strong association between promotion and performance.
Higher productivity is evaluated (Productivity: 69.3%)	$r=0.569$ ** (highest) p -value 0.000; $<\alpha$ H_{06} rejected	Higher outcome of the employees significantly influence employee motivation.
Lower output and demotion (Low_output: 72.5%)	$r=0.109$ *; p -value 0.11; $>\alpha$ H_{07} accepted	Lower output of employees insignificantly affects attitude.
Source: Matrix Table compiled from data output		

8.10.4 Factor Analysis of Performance Appraisal (PA)

Table 8.44: Descriptive and test results of EFA for performance appraisal practices

Descriptive Statistics: PA practices	Mean	SD	Test result
MBO based PA (<i>PA_MBO</i>)	4.368	0.523	KMO=0.60 C. Alpha=0.55 $\chi^2=279.449$ df.(21) p -val.0.000 N=400
Mechanisms of fair reward (Mecha_reward)	4.133	0.557	
On time promotion (<i>Timely promotion</i>)	2.955	0.917	
Promotion based on seniority (Seniority)	4.063	0.693	
Promoted based on performance (Promo_performance)	3.805	0.720	
Evaluation of higher productivity (Eva_productivity)	3.838	0.705	
Punishment to lower output (Punish_Low_output)	3.883	0.728	
Extraction: Principal Component Analysis; significantly data are suitable for EFA since KMO's,			

The Table 8.44 shows that the average value of all the factors of PA practices in the bank are >3 & 4 or even 4 (true or extent level). It is being observed that the MV of the variable *on time promotion* is 2.955 which is less than 3 as well. That means, employees are being got promotion on occasion. Therefore, performance appraisal (PA) practices in the banking sector of Bangladesh are in the factual level being observed.

Table 8.45: EFA and total variance explained for performance appraisal (PA) practices

Communalities: Performance Appraisal (PA) practices in Banks			Total Variance Explained				Remarks
			Initial (1.00) Eigenvalues		Extraction Sums of Squared Loadings		
Components	Initial	Extraction	Total	% of Variance	Total (>1)	% of Variance	
1. <i>Eva_productivity</i>	1.000	0.775	1.98	28.310	1.98	28.31	Loaded by 60%
2. <i>Promo_performn</i>	1.000	0.728	1.10	15.771	1.10	15.77	
3. <i>Mech_rewarding</i>	1.000	0.675	1.08	15.433	1.08	15.43	
4. PA_MBO	1.000	0.577	0.92	13.130	Deduction is not required since the percentage (%) of the initial Eigenvalues more than one observed in column 5.		
5. Timely_promo	1.000	0.525	0.86	12.250			
6. Promo_seniority	1.000	0.457	0.65	9.277			
7. Punish_lowoutpt	1.000	0.429	0.41	5.830			
All extraction values are >0.40 meaning that factors are supportive for high loadings. Total variance explained and loaded 60% (1+2+3).							

Table 8.45 shows that extraction values of 7 components are more than 40% the communality values from 1 to 7 out of seven factors. There are *three* factors with Eigenvalues of evaluation of productivity, promotion based performance and mechanisms of rewarding are 1.982, 1.104 and 1.080 respectively greater than 1.00. That means, these three components are highly loaded and covered 60% (28.310 +15.771+15.433) of the total variance explained (Field, 2013). In the performance appraisal practices the extracted three loaded communalities should reconsider by HR manager of the concerned banks for employee career development motivation. The extracted three variables have been shown in Figure 8.8 below.

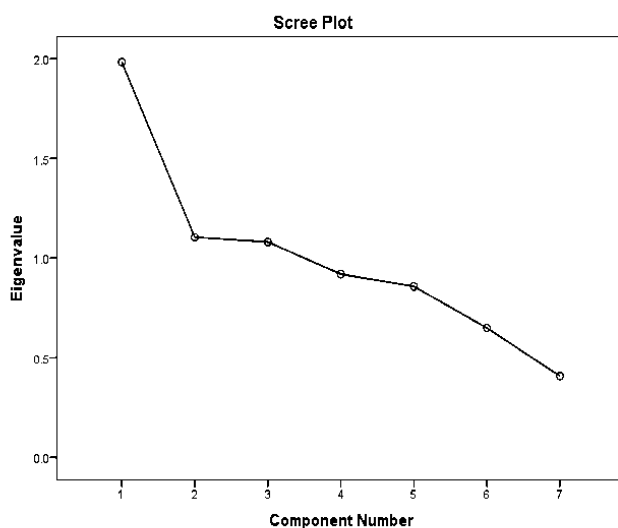

Figure 8.8: Scree plot of performance appraisal

Figure 8.8 shows the scree plot of Eigenvalues and depicting the top three communalities which have already been extracted i.e., evaluation of productivity, promotion based performance and mechanisms of rewarding are the most significant influencing employee behavior in the workplace.

8.10.5 Effective Factors of Performance Appraisal Explored by SEM

The measurement of SEM on PA confirms timely promotion, performance bases promotion and evaluation of performance of each employee as the effective factor of motivation (Annexure III).

8.11 HRM/ Management Practices

Empirical analysis of the HRM/management practices in the banking sector. In this section the study attempted to investigate the HRM/management practices in the selected ten banks. Proper human resource assessment requires the implementation of effective outcome/ feedback. The necessary corrective action can be taken by identifying significant error and measuring outcomes or feedback enhances its effectiveness. In addition, the successful human resource assessment is considered from direct direction of senior authorities and co-operative mentality of employees and has direct control over employees by authority also. The positive use of these elements plays an important role in the evaluation of best human resources. In Bangladesh, employee performance is evaluated by collecting confidential reports in different government, non-government and also autonomous business or other educational institutions. From fixed duration or time to time, the senior authority collects the reports of performance evaluation of subordinates from the departmental head. This section (8.D) management practices such as strategic HRM practices, job description and specification, fair recruitment and selection, evaluation of academic qualification and experience, opportunity to involve in association, equality and equity and employee retention policies. The employees' perception regarding the above factors have been analysed in this chapter (Table 8.46-8.55).

Table 8.46: Strategic human resource planning (SHRP) practices

Perception	Freq.	%	Remarks
Sometimes	3	0.8	From Table 8.46, researcher found that about 81% of the participants granted that SHRP practices in banking sector of Bangladesh obviously.
Often	58	14.5	
Very often	322	80.5	
Always	17	4.3	
Total	400	100.0	

Table 8.47: Fair recruitment and promotion systems (Fair R&P)

Perception	Freq.	%	Remarks
Often	15	3.8	It is being observed (Table 8.47) that 83.3% (maximum) of the respondents accepted positively that employees are recruited and selected fairly.
Very often	333	83.3	
Always	52	13.0	
Total	400	100.0	

Table 8.48: Job description and job specification (Job S & D)

Perception	Freq.	%	Remarks
Often	13	3.3	Researcher noticed (Table 8.48) that about 79% of the employees recognized that banking sector tried to develop job description and specification regarding staffing.
Very often	314	78.5	
Always	73	18.3	
Total	400	100.0	

Table 8.49: Academic qualification and job experience are valued (Eva_aca_quali)

Perception	Freq.	%	Remarks
Never	3	0.8	Table 8.49 shows that majority (74% and 22.8%) of respondents confirmed that academic qualification and job experience are being evaluated by the banking sector.
Sometimes	4	1.0	
Often	6	1.5	
Very often	296	74.0	
Always	91	22.8	
Total	400	100.0	

Table 8.50: Involvement with association is allowed (Association)

Perception	Freq.	%	Remarks
Never	64	16.0	Table 8.50 elucidates that 44.5% of the employees sanctioned that they are occasionally being allowed to involve with association.
Sometimes	140	35.0	
Often	179	44.8	
Very often	16	4.0	
Always	1	0.3	
Total	400	100.0	

Table 8.51: Exist equality and equity among the employees (Equity)

Perception	Freq.	%	Remarks
Often	18	4.5	Table 8.51 enlightens that 67.3% of the respondents positively approved that employees are treated equally.
Very often	269	67.3	
Always	113	28.3	
Total	400	100.0	

Table 8.52: Employee retention policies (long-termed employment) (Retention)

Perception	Freq.	%	Remarks
Sometimes	2	0.5	From Table 8.52 the study found that about 59% (highest) of the participants accepted that banking sector have employee retention policies influencing motivation.
Often	51	12.8	
Very often	234	58.5	
Always	113	28.3	
Total	400	100.0	

Observation on the perception level of employees regarding HRM/ management practices in the banking sector. The following table shows the overall frequency and Pearson correlation (r) and Chi-square test. The results are confirmed the impact of HRM practices on employee motivation and satisfaction practiced by the sampled banks (Table 8.52).

8.11.1 Bivariate Correlations among the Factors of Management Practices

Table 8.53: Matrix of frequency and bivariate correlation of management practices

Factors & Scale: (in %)	Pearson Correlation (r) and Chi ² test of Fisher's Exact p-value	
VO (4) and AL (5)	Sig. $\alpha=0.01$ ** (2-tailed)	Observation
Strategic Human Resource Planning (SHRM: 84.8%)	$r=1.00^{pc}$ p -value 0.001; $<\alpha$ H_{01} rejected	Significantly SHRM influence employee motivation in the banks. Alternative hypothesis (H_a) is sustained.
Fair recruitment and promotion (Fair R&P: 96.3%)	$r=0.158^{**}$ p -value 0.002; $<\alpha$ H_{02} rejected	Fair recruitment and due time promotion are highly related to employee motivation. H_a is accepted.
Job description and specification (Job S&D: 96.8%)	$r=0.564^{**}$ p -value 0.000; $<\alpha$ H_{03} rejected	Job specification and description are strongly associated to motivation. Significantly H_a is accepted.
Academic qualification and job experience are valued (Eva_aca_quali: 96.8%)	$r=0.209^{**}$ p -value 0.000; $<\alpha$ H_{04} rejected	Experience and academic qualification have significantly impact on motivation. Statistically H_a is accepted.
Involvement with association is allowed (Association: 4.3%)	$r=(-0.019)^*$ p -value 0.702; $>\alpha$ H_{05} supported	There is insignificant impact of the involvement in the association on motivation. Statistically H_a is rejected.
Exist equality and equity among the employees (Equity: 95.6 %%)	$r=0.169^{**}$ p -value 0.001; $<\alpha$ H_{06} rejected	Significant effect being observed relating to equality in terms of motivation. Statistically H_a is accepted.
Employee retention policies (long-termed employment) (Retention: 86.8%)	$r=0.467^*$ p -value 0.000; $<\alpha$ H_{07} rejected	Significant relationship between retention policies and employee motivation is noticed. Statistically H_a is sustained.
pc is the perfect correlation. ** Correlation is significant at 0.01 (2-tailed) and *Correlation sig. at 0.05 (1-tailed). Job description is highly correlated ($r=0.564$) ** with variables and involvement with association is negative ($r = (-0.019)^*$).		

Mean comparison with Levene's t-test for equality of variances among the factors of HRM practices in the banks (Table 8.54).

8.11.2 Management Practices in Public and Private Bank

Table 8.54: Management practices in public and private bank

Factors: HRM	Public Bank		Private Bank		Levene's Test for Equality of Variances			
	Mean	SD	Mean	SD	MD	F	Sig.	Status
SHRM	3.84	0.44	4.04	0.46	-0.19	2.24	0.140	Private>Public
Fair_R&P	4.10	0.38	4.08	0.47	0.02	1.66	0.200	Public>Private
Job_speci_des	4.17	0.43	4.06	0.47	0.11	0.80	0.370	Public>Private
Eva_aca_quali	4.18	0.55	4.13	0.62	0.06	8.37	0.004^a	Public>Private
Association	2.47	0.78	2.00	0.80	0.47	0.02	0.900	Public>Private
Equality	4.33	0.50	3.88	0.46	0.45	28.16	0.000^b	Public>Private
Retention	4.32	0.52	3.45	0.59	0.87	6.66	0.010^c	Public>Private
Overall_Prac	3.92	0.52	3.66	0.56	0.26	6.84	0.230^d	*Public>Private

Remarks: MD= Mean Difference; SD = Standard Deviation; 95% Conf. Interval of the Difference; Sig. (2-tailed). The p -value **0.004^a, 0.000^b, 0.010^c** $p < 0.05$ and **0.23^d**; $p > 0.05$.

Overall mean value of public bank (Table 8.54) is more than private bank (mean value are respectively 3.92 and 3.66). Evaluation of academic qualification, equality, and retention policies are most significant factors for management. A strategic HRM practice was more than that of public banks. Therefore, it appears that management practices in state-owned banks more than public bank. It is cleared that the evaluation of academic qualification, equal importance and retention have the impact on employee motivation in management practices (p -value 0.004^a, 0.000^b, 0.010^c that means p -values of the three factors are less than 0.05).

8.11.3 EFA of Management Practices

Table 8.55: Descriptive and EFA for management practices

Management practices	Mean	SD	Test result
Strategic Human Resource Planning (SHRM)	3.883	0.452	KMO=0.60 $\chi^2=340.31$ df.=21 p -val.=0.000 N=400
Fair recruitment and promotion (Fair R&P)	4.093	0.399	
Job description and specification (Job des_specific)	4.150	0.439	
Academic qualification is valued (Eva_aca_qua)	4.170	0.567	
<i>Involvement with Association (Association)</i>	2.375	0.807	
Existing equality and equity (Equality)	4.238	0.521	
Employee retention policies (Retention)	4.145	0.640	

Extraction: Principal Component Analysis; significantly data are suitable for EFA

Table 8.55 shows that the mean values (MV) of all the above factors of *Management Practices* are >4 (extent or true level of perception) except a single factor i.e., *involvement in association* (MV 2.375 $<$ 3; poor level). Therefore, management practices in the banking sector of Bangladesh are good or true level observed.

Table 8.56: EFA and total variance explained of management practices

Communalities: Management Practices			Total Variance Explained				Remarks on highly loadings
			Initial (1.00) Eigenvalues		Extraction Sums of Squared Loadings		
Components	Initial	Extraction	Total	% of Variance	Total (1>)	% of Variance	
1. Job des_specifi	1.000	0.725	2.014	28.769	2.014	28.769	Loaded by 63.37%
2. Fair R & P	1.000	0.720	1.337	19.095	1.337	19.095	
3. Association	1.000	0.707	1.008	14.393	1.008	14.393	
4. Retention	1.000	0.673	0.976	13.939	-	-	-
5. Eva_aca_quali	1.000	0.668	0.712	10.177	-	-	-
6. Equality	1.000	0.651	0.531	7.587	-	-	-
7. SHRP*	1.000	0.214	0.423	6.040	-	-	-
SHRP* extraction is < 0.40. Total variance explained and loaded 62.37% (1+2+3)							

Table 8.56 shows that extraction values of 6 components were more than 40% the communality values from 1 to 6 out of seven factors. There are *three* factors with Eigenvalues of job description & specification, fair recruitment & promotion and involvement in the union or association were 2.014, 1.337 and 1.008 respectively > 1.00 (initial value). That means, these three components are highly loaded and covered ~63.37% (28.769 +19.095+14.393) of the total variance explained. In the management practices these three loaded and variance explained factors should review in the sampled banks for employee motivation.

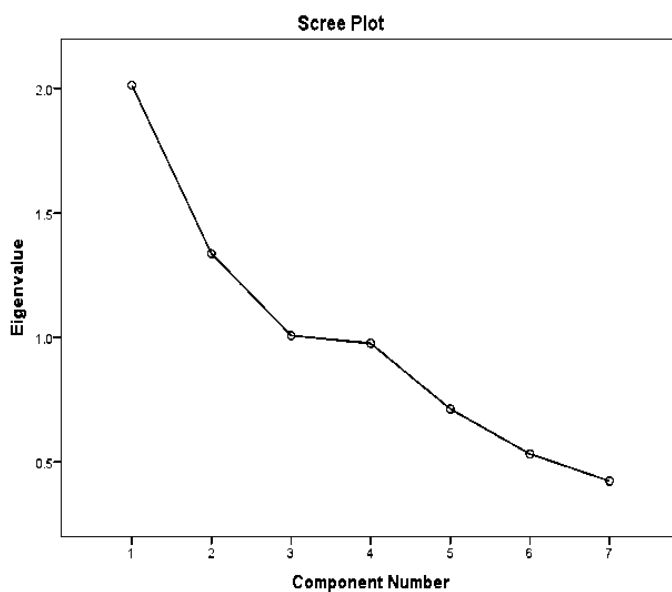

Figure 8.9 shows the scree and component plot of Eigenvalues and depicting two factors are creating elbow shape and maximum proportion variance is explained in the graph. The top three communalities have been extracted i.e., job description & specification, fair recruitment & selection and involvement in the union or association are the most significant.

Figure 8.9: Scree plot of management practices

8.11.4 Effective Factors of Management Practices by Using SEM

From the SEM on management practices confirms that the fair recruitment and selection is the most effective factor influencing employee motivation (Annexure IV).

8.12 Discussion on Findings

The highest score for treating HRD as a separate unit is 99% (agreed and strongly agreed) which has a significant positive impact on employee satisfaction in the banking sector found. Also, it has shown that the banking industry practices the HRD process applied among its employees. The practices of HRD mechanisms of the private banks were higher than the average of all the factors of the public sector banks. Organizational change and development has a strong impact on the HRD mechanism and employee motivation in the banking sector was also examined.

Moreover, it further showed that the banking industry practices OCTAPACE applied to its employees. With the exception of 14% of autonomy (A), almost all perceptions are over 50%. Job autonomy practices in both the banks showing dissatisfaction among the employees. HRD climate or OCTAPACE culture or (eight variables) practices are being observed in the private bank rather than public bank. Trust, proactiveness, authenticity, collaboration and experimentation are highly practicing in the public bank than the private bank. Note here that the principal officers are more being satisfied / motivated than the officers. Therefore, 8-culture (OCTAPACE) in HRD climate practice or sector show good picture.

PA practice has the significant effect on the employee motivation. It has been found that MBO, fair rewarding, on time promotion, performance based promotion and higher outcomes of employees influenced motivation. In addition, the successful human resource assessment is considered from direct and direction of senior authorities and co-operative mentality of employees and has direct control over employees by authority also. The positive use of these elements plays an important role in the evaluation of best human resources. In Bangladesh, employee performance is evaluated by collecting confidential reports in different government, non-government and also autonomous business or other educational institutions. From fixed duration or time to time, the senior

authority collects the reports of performance evaluation of subordinates from the departmental head.

A strategic HRM practice is more than public banks. Thus, it appears that the practice of management nationalized banks is more than that of a public bank as a whole. It is cleared that the assessment of academic aptitude, equal importance, and perception influence the motivation of employees in the management process.

Besides, role analysis is the most effective factor among the associated variables in HRD mechanisms. The risk taking and fair rewarding ($\beta=3.327>1$) along with autonomy ($\beta=2.283>1$) are the highly effective factors involved in the latent factor i.e., OCTAPACE culture. The study explored confirming performance appraisal (PA) as the latent factor whereas, promotion based on performance ($\beta=3.35$, i.e., >1), on time promotion ($\beta=2.24>1$) and productivity evaluation ($\beta=2.23 >1$) influenced as the most effective factors of employee motivation in the banking industry (Annexure III). The listing the observed variables with coefficient values of the latent variable *Management practices* ($\beta=0.003$) are strategic HRM practices –SHRM ($\beta=1$, constrained), fair recruitment ($\beta=6.155>1$), job description ($\beta=4.322>1$), evaluation of academic qualification ($\beta=3.284$), association involvement ($\beta=1.486>1$), equality ($\beta=2.299>1$) and retention ($\beta=4.750>1$). All these factors' coefficient values are >1 . Among these *fair recruitment* ($\beta=6.155$) is the strongest factor (Annexure IV).

The latent factors viz. HRD mechanisms ($\beta=0.130$), OCTAPACE ($\beta=0.074$), PA ($\beta=0.037$) and Management Practices ($\beta=0.003$) whereas the study found that coefficient values of all the factors of both latent factors are positive and within 1.0.

Therefore, these factors have the significant relationship and effect on employee motivation in the banks.

Chapter Nine

Organizational Effectiveness and Employee Motivation

Background

Human Resource Development (HRD) is concerned with the process of ensuring operational capacity, knowledge, personality, insight, observation and decision-making ability of an employee to achieve the desired organizational goals and responsibilities of current and future work. HRD is involved in developing managerial knowledge and skills to create managers well. This type of managerial development can be ensured through education and proper training programs as well as HRD environment. This chapter has focused on the two dimensions namely *employee outcomes*, and *organizational outcomes*. The aim of this chapter is to examine the effect of organizational effectiveness on employee motivation representing the study objective number 7 (seven).

9.1 Why Need Organizational Effectiveness?

Organizational Effectiveness HR executives can ensure employee performance through HRD practice in order to maximize organizational results in relation to the desire to achieve results. In these situations, the experience gained among developers through HRD practice will be observed. Clearly it can be noticed that there is a positive relationship between HRD and the effectiveness of the organization. TV Rao (1990)¹ assumed that an organization with capable, satisfied, committed and dynamic HR is considered as a potential or well-defined performance. HRD faces many problems, including low results. The HRD climate of an organization is better and its practices are more likely to be more effective than those of other organizations. It is transparent that the variables in HRD results are a step-by-step step towards the effectiveness of the organization. Through HRD practice, an organization can create a gateway to training and development that provides a culture of excellence that ensures strong leadership. HRD processes affect HRD outcomes.

¹ TV Rao, *The HRD Missionary*, (New Delhi: Oxford IBH, 1990): 7.

9.2 How HRD Outcomes Variables Contribute to Develop Employee and Organizational Effectiveness?

HRD matrix matches/co-ordinates between individual and organizational needs and it is the framework for the expansion of work environment with a view to achieving the individual and organizational outcomes or effectiveness. HRD enables employees for better performance in present and future jobs.

9.3 Employee Outcomes

Employee outcomes enables employee more innovative, competence, committed performance, capability to solve problem for which an employee may satisfy his/ her position. This section has discussed on how an employee contributes to the attainment of organizational effectiveness and observed the practices of HRD Matrix in the banks.

9.4 Effect of Employee and Organizational Outcomes

The study has examined that how HRD mechanisms contribute indirectly to increase employee productivity, how HRD process enhances HR policies and OCTAPACE enables employee more capable and productive in practice (Table 9.1).

Table 9.1: Effect of HRD matrix and practices

Outcomes	Measures	Impact
Employee	Affective reactions	Satisfaction and commitment
	Behavioral reactions	Absenteeism and turnover
Organizational	Operational	Quality, productivity and customer satisfaction
Financial	Accounting	Profit and casual chain.
Market	Market value	Effect on stock price

9.4.1 Statistical Analysis of Employee Outcomes

Table 9.2: More competent and work innovative employees (Competent_inno)

Perception	Freq.	%	Remarks
Disagree (D)	1	0.3	From the Table 9.2 researcher found that about 73.3% (highest) of the respondents confirmed that HRD practices have created more skilled and innovative employees.
Moderately agree (MA)	64	16.0	
Agree (A)	293	73.3	
Strongly agree (SA)	42	10.5	
Total	400	100.0	

Table 9.3: Rating better manpower development (HR_dev)

Perception	Freq.	%	Remarks
Moderately agree	55	13.8	The Table 9.3 describes that the majority of participants (75.3%) allowed the development of more advanced manpower through HRD practice in the banking sector.
Agree	301	75.3	
Strongly agree	44	11.0	
Total	400	100.0	

Table 9.4: High quality work commitment and performance (Commitment & performance)

Perception	Freq.	%	Remarks
Moderately agree	44	11.0	The Table 9.4 clarifies that approximately 65% of respondents agreed that high quality work commitment and performance is ensured by HRD practices at banks.
Agree	259	64.8	
Strongly agree	97	24.3	
Total	400	100.0	

Table 9.5: Problem solving skills leading to employee productivity (Prob_solving)

Perception	Freq.	%	Remarks
Moderately agree	24	6.0	It has been observed (Table 9.5) that most of the employees in the banking sector (57% and 37%) have approved that the employees are able to solve the problem which will have a positive impact on productivity.
Agree	228	57.0	
Strongly agree	148	37.0	
Total	400	100.0	

Table 9.6: Better utilization of human resources (Utilization_HR)

Perception	Freq.	%	Remarks
Moderately agree	29	7.3	It is noted (Table 9.6) that the 71.5% (maximum) respondents confirmed that employee HRs developed through the massive utilizing of the output of the HRD.
Agree	286	71.5	
Strongly agree	85	21.3	
Total	400	100.0	

Table 9.7: Higher job satisfaction and work motivation (Satis_motivation)

Perception	Freq.	%	Remarks
Moderately agree	35	8.8	The survey from the Table 9.7 shows that the majority of the employees in the banking sector of Bangladesh (60.5%) positively accepted that the employees are being highly satisfied and motivated through the practice of HRD matrix.
Agree	322	80.5	
Strongly agree	43	10.8	
Total	400	100.0	

9.4.2 Reflection of Employee Outcomes

This unit has shown the short observation of frequency and correlation constructing a score matrix (Table 9.8).

Table 9.8: Score matrix of frequency and Pearson's correlation for employee outcomes (> 50%)

Employee outcomes	High (A+SA)	Moderate	Correlation	p-value	Significant
Competnt_inno	335 (84%)	65 (16%)	r= 1.00*	0.000	Strongly significant; **Correlation is significant at 0.001 (2-tailed). r=1.00* perfect positive correlation.
HR_dev	345 (86%)	55 (14%)	r= 0.525**	0.000	
Commit_performnce	356 (89%)	44 (11%)	r= 0.600**	0.000	
Prob_solving	376 (94%)	24 (6%)	r= 0.535**	0.000	
Utilization_HR	371 (93%)	29 (7%)	r= 0.400**	0.000	
Satis_motivation	365 (91%)	35 (9%)	r= 0.373**	0.000	

It shows $r=0.600^{**}$ (highest) and p -value $0.000 < 0.05$. The highest score of *problem solving capability* is 94% which does have the significant impact of employee outcomes in banks. Moreover, it has been found that all the values of opinions are

greater than 50% confirming the effectiveness of HRD in the banking sector of the study area (Table 9.8).

9.4.3 Investigating Employee Outcomes of Public and Private Bank

Here, it has been investigated the employees outcomes practiced in the public and private banks. The Levene's Test of means comparison is used in this entity.

Table 9.9: Satus of employee outcomes between public and private bank

Employee outcomes	Public Bank		Private Bank		Levene's Test for Equality of Variances			
	Mean	SD	Mean	SD	MD	F	Sig.	Status
Competnt_inno	3.91	0.54	4.05	0.45	-0.14	4.323	0.038	Private>Public
HR_dev	3.95	0.50	4.08	0.50	-0.13	1.618	0.204	Private >Public
Commitmnt & performance	4.13	0.60	4.13	0.90	0.01	0.108	0.742	Public>Private
Prob_solving	4.33	0.57	4.21	0.59	0.12	5.448	0.020^a	Private >Public
Utilization_HR	4.14	0.53	4.15	0.48	-0.01	0.494	0.482	Private>Public
Satis_motivatn	4.04	0.44	3.94	0.43	0.10	0.019	0.890	Public>Private
Overall	4.09	0.53	4.09	0.49	-0.00	2.002	0.396^b	Private>Public

Here, MD = Mean Difference; SD = Standard Deviation; 95% Conf. Interval of the Difference; Sig. (2-tailed). The obtained p -value **0.020^a** $p>0.05$ and **0.396^b**; $p<0.05$.

It is being observed in Table 9.9 that employees' outcomes of the both banks almost same (Mean value were 4.09 and 4.09 of the both banks). But overall mean values of satisfaction and work motivation of public bank (SOBs) employees are higher than that of the private bank (mean value are 4.041 and 3.938; public >private bank) is being remarked. There is an association between competent and employee outcomes in the banking organization (p -value $0.038<0.05$). Employee outcomes and innovative have a strong impact on the motivation (p -value $0.020<0.05$) regarding organizational effectiveness in the banking organization.

9.4.4 Factor Analysis on Employee Outcomes

Table 9.10: Descriptive and test results of employee outcomes

Employee outcomes	Mean	SD	Test result
More competent and innovative (Competent_Inno)	3.940	0.522	KMO=0.78 $\chi^2=622.99$ df.=15 p -value =0.000 N=400; PCA Data are good fit
Better HR development rates (HR_development rate)	3.973	0.498	
High quality and committed performance (Quality_perform)	4.133	0.580	
Problem solving skills (Problem_solving)	4.310	0.579	
Better utilization of HRs (better_HRs utilization)	4.140	0.516	
High satisfaction and motivation (satisfaction_motivation)	4.020	0.442	

Table 9.10 showed that the mean values of competent & innovation, HR development rate, quality performance, problem solving skill better utilization of resources and higher satisfaction and motivation of the *employee outcomes* in HRD

Matrix are more than 4 (extent level) or even 4. Therefore, employee outcomes of HRD Matrix show the good practices in the study area.

Table 9.11: EFA and total variance explained for employee outcomes

Communalities: HRD Matrix and Employee Outcomes			Total Variance Explained				Remarks on highly loadings
			Initial (1.00) Eigenvalues		Extraction Sums of Squared Loadings		
Components	Initial	Extraction	Total	% of Variance	Total (>1)	% of Variance	
1. <i>Competent_inno</i>	1.000	0.755	2.799	46.648	2.799	46.648	Loaded by 65%
2. <i>HR_development</i>	1.000	0.747	1.088	18.129	1.088	18.129	
3. <i>Quality_perfrmnce</i>	1.000	0.674	0.707	11.790	-	-	-
4. <i>Better HRs utili</i>	1.000	0.591	0.597	9.948	-	-	-
5. <i>Satisf_ motivation</i>	1.000	0.560	0.452	7.527	-	-	-
6. <i>Prob_solving skills</i>	1.000	0.559	0.357	5.958	-	-	-

Extraction values of all components are >0.40. Total variance explained and loaded covering (1+2) ~65%.

Table 9.11 showed that extraction values of six components are more than 40% the communality values from 1 to 6 out of six factors. There are two factors with Eiganvalues of employee competent and HR development rate are 2.799 and 1.088 respectively more than 1.00. That means, these two components are highly loaded and covered 65% (46.648 +18.129) of the total variance explained. In the employee outcomes of HRD Matrix innovative and HR development rate may retrace in the sampled banks for employee motivation since employee outcomes are strongly related to satisfaction.

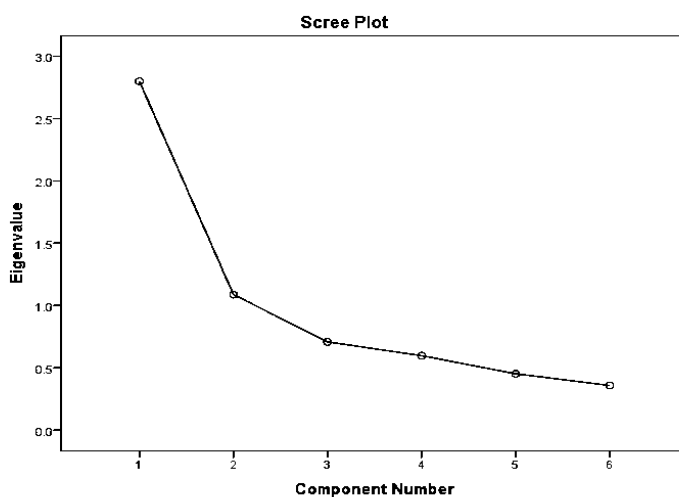

Figure 9.1: Scree plot on employee outcomes

The Figure 9.1 depicted the screen plot of the aggregate values and creates an elbow shape depicting two subjects and the variation of the maximum proportions is explained in the graph. The top three communalities have been extracted, enabled and the rate of HR development is the biggest reason here.

9.5 Organizational Outcomes

The effectiveness of the organization is a systematic approach to improving the whole organization on a regular basis. The ability of the organization to pursue goals using

performance capabilities; specific organizational activities aimed at achieving predetermined outcomes (performance actions); overall system performance results (outcomes); change in life (results); and feedback from all stakeholders about the organization's effectiveness in relation to desired outcomes and outcomes (environmental responses). Feedback is important because it continuously improves strategy, resources, performance capabilities, performance actions and consequential outcomes and outcomes. In this section generation of internal assets, safety environment, team work, productivity, higher profits as well as image of the banks have been discussed to show the impact on employee motivation.

9.5.1 Statistical Analysis of Organizational Outcomes in the Banks

Table 9.12: Generation of internal resources

Perception	Freq.	%	Remarks
Moderately agree	70	17.5	The Table 9.12 explains that 71.5% of the respondents positively acknowledged that internal resources are being created in the banking sector of Bangladesh through the practice of HRD matrix.
Agree	286	71.5	
Strongly agree	44	11.0	
Total	400	100	

Table 9.13: Better organizational health and safety

Perception	Freq.	%	Remarks
Moderately agree	66	16.5	From the Table 9.13 the study found that 73% of participants participated in the HRD matrix and its practices in the banking sector creating better organizational health and safety.
Agree	292	73.0	
Strongly agree	42	10.5	
Total	400	100.0	

Table 9.14: Greater teamwork

Perception	Freq.	%	Remarks
Moderately agree	42	10.5	The Table 9.14 showed that the majority of respondents (70.3%) confirmed that larger teams must have worked through HRD practice in the sampled banks.
Agree	281	70.3	
Strongly agree	77	19.3	
Total	400	100.0	

Table 9.15: Higher productivity

Perception	Freq.	%	Remarks
Moderately agree	43	10.8	The Table 9.15 states that the highest number of participants (74.5%) ensured that HRD practice in sampled banks undoubtedly being increased high productivity.
Agree	298	74.5	
Strongly agree	59	14.8	
Total	400	100.0	

Table 9.16: Growth and diversification

Perception	Freq.	%	Remarks
Disagree	2	0.5	It has been found (Table 9.16) that 59% of employees must agree that only the HRD matrix practices in the banking industry affect organizational growth and diversification.
Moderately agree	128	32.0	
Agree	236	59.0	
Strongly agree	34	8.5	
Total	400	100.0	

Table 9.17: Less turnover, no loss time and cost reduction

Perception	Freq.	%	Remarks
Disagree	7	1.8	From the Table 9.17 the researcher perceived that 47.5% (highest) of the employees granted that HRD practices in their banks reducing cost, time and turnover.
Moderately agree	117	29.3	
Agree	190	47.5	
Strongly agree	86	21.5	
Total	400	100.0	

Table 9.18: Higher profits

Perception	Freq.	%	Remarks
Moderately agree	61	15.3	It has identified (Table 9.18) that the highest (79.5%) respondents positively perceived the higher returns obtained by HRD matrix practice in the sampled banks.
Agree	318	79.5	
Strongly agree	21	5.3	
Total	400	100.0	

Table 9.19: Better image

Perception	Freq.	%	Remarks
Disagree	1	0.3	The Table 9.19 separates that 73.5% (maximum number) of employees are being approved that the organizational good figure depends on better practice of the HRD matrix.
Moderately agree	72	18.0	
Agree	294	73.5	
Strongly agree	33	8.3	
Total	400	100.0	

9.5.2 Association among the Factors of Organizational Outcomes

Here is the observation on perception of frequency and correlation in terms of organizational outcomes or effectiveness shown (Table 9.20).

Table 9.20: Score of frequency and correlation of organizational outcomes

Orgn. outcomes	High (A+SA)	Moderate	Correlation	p-value	Significant
Generating resources	330 (83%)	70 (17%)	r= 1.00 ^{pc}	0.000	Highly significant; ^{**} Correlation is significant at 0.001 (2-tailed). r=1.00 ^{pc} perfect positive correlation.
Health_safety	334 (84%)	66 (16%)	r=0.653^{**}	0.000	
Gre_teamwork	358 (90%)	42 (10%)	r= 0.577 ^{**}	0.000	
High productivity	357 (90%)	43 (10%)	r= 0.513 ^{**}	0.000	
Growth_Diver	270 (68%)	128 (32%)	r= 0.394 ^{**}	0.000	
Less turnover	276 (69%)	117 (29%)	r= 0.528 ^{**}	0.000	
Higher profits	339 (85%)	61 (15%)	r= 0.441 ^{**}	0.000	
Better image	327 (82%)	72 (18%)	r= 0.552 ^{**}	0.000	

The Table 9.20 that showed $r=0.653$ (maximum in healthy and safety) and p -value $0.000<0.05$. High frequencies of all factors are $>50\%$. The highest score regarding *team work* as well as *higher productivity* are 90% which do have the significant impact of organizational outcomes in banks (p -value 0.000). Besides, it is confirmed that all the values of counted perception regarding organizational outcomes are more than 50% which observing the HRD effectiveness practiced in the banking industry (Table 9.20).

9.5.3 Organizational Outcomes Practices in the Public and Private Bank

Table 9.21: Status of organizational outcomes between public and private bank

Organizational outcomes	Public Bank		Private Bank		Levene's Test for Equality of Variances			
	Mean	SD	Mean	SD	MD	F	Sig.	Status
Internal_resrce	3.94	0.55	3.93	0.44	0.013	3.084	0.080	Public>Private
Health_safety	3.93	0.53	3.99	0.46	-0.059	4.445	0.036^a	Private >Public
Gre_teamwork	4.11	0.55	3.99	0.49	0.125	6.703	0.010^b	Public>Private
High_prodtivty	4.05	0.51	4.01	0.49	0.034	0.747	0.388	Public>Private
Growth_Diver	3.77	0.63	3.69	0.49	0.084	2.570	0.110	Public>Private
Less turnover	4.00	0.73	3.43	0.65	0.578	0.971	0.325	Public>Private
Higher profits	3.91	0.45	3.88	0.43	0.031	0.083	0.773	Public>Private
Better image	3.93	0.51	3.78	0.50	0.153	4.179	0.042^c	Public>Private
Overall	3.95	0.56	3.84	0.50	0.120	2.848	0.221^d	*Public>Private

Remarks: MD = Mean Difference; SD = Standard Deviation; 95% Conf. Interval of the Difference; Sig. (2-tailed). p -value **0.036^a**, **0.010^b**, and **0.042^c**; $p>0.05$ (significant) and **0.221^b**; $p<0.05$ (insignificant).

It has been observed from Table 9.21 that organizational outcomes of the both banks almost same. On the other hand, overall * mean value of public bank are higher than the private bank (3.954 and 3.835 respectively) but slightly difference being perceived. It has been found that health and safety influences the organizational effectiveness (p -value is $0.036<0.05$). There is a relationship between greater teamwork and organizational outcomes in the banking industry (p -value $0.010<0.05$). Better image of the banking organization affects employee motivation in terms of organizational effectiveness (p -value $0.042<0.05$).

9.5.4 Factor Anlysis of Organizational Outcomes in the Banks

Table 9.22: EFA and test result of organizational outcomes

Organizational Outcomes	Mean	SD	Test result
Generating internal resources (Generating resources)	3.932	0.529	KMO=0.86 $\chi^2=1183.63$ df.=28 p -value =0.000 N=400; PCA Data are excellent fit for EFA
Better health and safety (Orgnal_healthh)	3.937	0.515	
Greater teamwork (Greater_team)	4.085	0.538	
Higher productivity (Higher_productivity)	4.038	0.502	
Growth and diversification (Growth_diversity)	3.754	0.606	
Less turnover, and cost reduction (Cost_reduction)	3.887	0.753	
Higher profits (Higher_profit)	3.900	0.443	
Better image (Better_image)	3.897	0.513	

The above Table 9.22 depicted that mean values of the factors such as generating internal resources, organizational health, greater team work, higher productivity, growth diversity, cost reduction, higher profit and better image are greater than 3 or about 4 and more than 4 (true level). Therefore, organizational outcomes show the good figure in the sampled banks.

Table 9.23: EFA and total variance explained for organizational outcomes

Communalities: Organizational Outcomes			Total Variance Explained				Remarks on loadings
			Initial (1.00) Eigenvalues & Variance with %		Extraction Sums of Squared Loadings (%)		
Components	Initial	Extraction	Total	Variance (%)	Total	Variance	
1. <i>Better image</i>	1.000	0.743>.40	3.981	49.762	3.981	49.76%	Loaded by 63%
2. <i>Internal resource</i>	1.000	0.717>.40	1.050	13.120	1.050	13.12%	
3. Better health	1.000	0.713>.40	0.691	8.635	-	-	-
4. Higher profits	1.000	0.646>.40	0.600	7.498	-	-	-
5. Greater teamwork	1.000	0.615>.40	0.526	6.574	-	-	-
6. Cost reduction	1.000	0.555>.40	0.453	5.658	-	-	-
7. Diversification	1.000	0.546>.40	0.393	4.909	-	-	-
8. Higher productivity	1.000	0.494>.40	0.307	3.843	-	-	-

All extraction values are >0.40. Total variance explained and loaded covering (1+2) ~63%.

The Table 9.23 shows that extraction values of eight components are more than 40% the communality values from 1 to 8 out of eight factors. There are two factors with Eigenvalues of better image and generating internal resources are 3.981 and 1.050 respectively more than 1.00. That means, these two components are highly loaded and covered ~63% (49.762 +13.120) of the total variance explained. Since the better image and generating internal resources highly loaded and varied that’s why, these two factors could reconsider by the sampled banks.

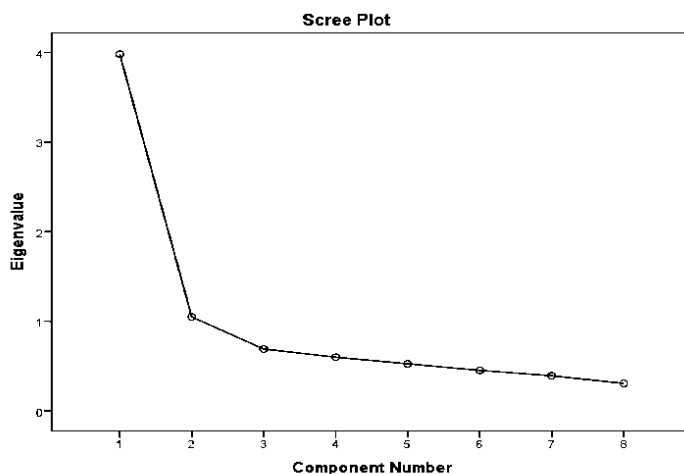

Figure 9.2 depicted the scree plot of Eigenvalues and depicting two factors are creating elbow-shaped and maximum proportion variance is explained in the graph. The top two communalities have been extracted i.e., better image and generating internal resources are the most weighty factors.

Figure 9.2: Scree plot of organizational outcomes

9.5.5 Exploring Effective Factors from Organizational Effectiveness Measured by SEM

This unit has explored the effective factors in terms of organizational effectiveness through using SEM of the two latent factors i.e., employee and organizational outcomes (Table 9.24 and Figure 9.3).

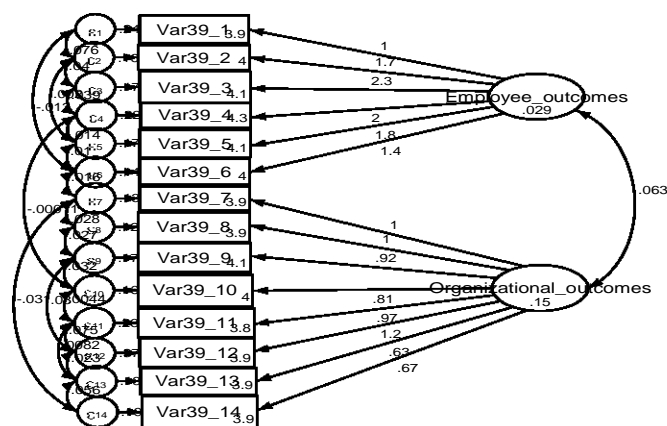

Figure 9.3 confirms the SEM structure showing employee (Latent factor-LF1; $\beta=0.029$) and organizational outcomes (LF2; $\beta= 0.15$) of the HRD matrix. The figure also shows the mean values of all variables in the houses.

Figure 9.3: SEM of employee & organizational outcomes (Organizational effectiveness)

Table 9.24: Measurement for SEM on organizational effectiveness

Particulars (Measurement)	Coef.	S.E	z	p>z	95% Conf. Interval	
Employee Outcomes (Latent factor 1)						
Var39_1 (Competent_innovative)	<-					
	1	(constrained)				
_cons	3.95	0.026	151.3	0.000	3.890	3.991
Var39_2 (HR_development rate)	<-					
	1.70	0.250	6.78	0.000	1.204	2.519
_cons	3.97	0.025	162.0	0.000	3.924	4.021
Var39_3 (Commnt_performance)	<-					
	2.35	0.392	5.98	0.000	1.576	3.115
_cons	4.13	0.029	143.3	0.000	4.253	4.367
Var39_4 (Solving_skills)	<-					
	2.00	0.355	5.62	0.000	1.299	2.691
_cons	4.31	0.029	149.1	0.000	4.253	4.367
Var39_5 (Better_HR_utilizn)	<-					
	1.85	0.330	5.61	0.000	1.203	2.496
_cons	4.15	0.029	160.7	0.000	4.089	4.189
Var39_6 (Higher_satis_motivn)	<-					
	1.38	0.263	5.25	0.000	0.863	1.892
_cons	4.02	0.022	182.3	0.000	3.977	4.063
Organizational Outcomes (Latent factor 2)						
Var39_7 (Internal resources)	<-					
	1	(constrained)				
_cons	3.94	0.026	148.6	0.000	3.883	3.987
Var39_8 ((Health and safety)	<-					
	1.02	0.065	15.52	0.000	0.887	1.143
_cons	3.94	0.026	152.7	0.000	3.889	3.991
Var39_9 (Greater teamwork)	<-					

Organizational Effectiveness and Employee Motivation

	0.92	0.080	11.56	0.000	0.767	1.080
_cons	4.10	0.027	151.4	0.000	4.035	4.140
Var39_10 (Higher productivity)	<-					
	0.81	0.074	10.93	0.000	0.665	0.955
_cons	4.04	0.0252	160.5	0.000	3.991	4.089
Var39_11 (Growth & diversity)	<-					
	0.97	0.089	10.97	0.000	0.798	1.146
_cons	3.76	0.030	124.3	0.000	3.696	3.814
Var39_12 (Less turnover cost)	<-					
	1.16	0.113	10.32	0.000	0.940	1.391
_cons	3.89	0.038	103.5	0.000	3.814	3.961
Var39_13 (Higher profits)	<-					
	0.63	0.066	9.63	0.000	0.503	0.760
_cons	3.9	0.023	177.7	0.000	3.857	3.943
Var39_14 (Better image)	<-					
	0.67	0.080	8.33	0.000	0.512	0.827
_cons	3.9	0.026	153.0	0.000	3.848	3.947
var(e.Var39_1)	0.24	0.018			0.210	0.279
var(e.Var39_2)	0.16	0.123			0.135	0.184
var(e.Var39_3)	0.17	0.016			0.146	0.208
var(e.Var39_4)	0.22	0.018			0.186	0.259
var(e.Var39_5)	0.17	0.014			0.142	0.195
var(e.Var39_6)	0.14	0.011			0.012	0.163
var(e.Var39_7)	0.14	0.012			0.113	0.161
var(e.Var39_8)	0.17	0.011			0.096	0.140
var(e.Var39_9)	0.17	0.014			0.142	0.198
var(e.Var39_10)	0.16	0.013			0.135	0.185
var(e.Var39_11)	0.23	0.018			0.194	0.266
var(e.Var39_12)	0.37	0.029			0.315	0.429
var(e.Var39_13)	0.14	0.010			0.116	0.156
var(e.Var39_14)	0.19	0.015			0.167	0.225
var(Employee_outcomes; LF1)	0.03	0.010			0.015	0.055
var(Organizational_outcomes; LF2)	0.15	0.019			0.113	0.188
---	---	---	---	---	---	---
cov(e.Var39_1,e.Var39_2)	0.08	0.011	6.92	0.000	0.055	0.098
cov(e.Var39_1,e.Var39_6)	-0.01	0.009	-1.41	0.159	-0.029	0.005
cov(e.Var39_2,e.Var39_3)	0.04	0.009	4.26	0.000	0.022	0.058
cov(e.Var39_2,e.Var39_5)	0.01	0.008	0.25	0.800	-0.014	0.018
cov(e.Var39_3,e.Var39_4)	0.04	0.012	3.26	0.001	0.016	0.062
cov(e.Var39_4,e.Var39_5)	0.01	0.011	1.33	0.185	-0.006	0.036
cov(e.Var39_4,e.Var39_10)	-0.00	0.010	-0.01	0.99	-0.019	0.019
cov(e.Var39_5,e.Var39_6)	0.01	0.008	1.18	0.237	-0.007	0.027
cov(e.Var39_6,e.Var39_7)	0.05	0.008	2.09	0.036	0.001	0.031
cov(e.Var39_7,e.Var39_8)	0.03	0.009	3.32	0.001	0.012	0.045
cov(e.Var39_7,e.Var39_14)	0.03	0.008	-3.74	0.000	-0.047	-0.015
cov(e.Var39_8,e.Var39_9)	0.03	0.008	3.31	0.001	0.011	0.043
cov(e.Var39_9,e.Var39_10)	0.03	0.010	3.45	0.017	0.005	0.050
cov(e.Var39_9,e.Var39_12)	0.03	0.013	2.39	0.017	0.005	0.056
cov(e.Var39_10,e.Var39_11)	0.01	0.010	0.44	0.658	-0.015	0.024
cov(e.Var39_11,e.Var39_12)	0.08	0.070	4.45	0.000	0.042	0.109
cov(e.Var39_11,e.Var39_13)	0.01	0.009	0.91	0.362	-0.009	0.026
cov(e.Var39_12,e.Var39_13)	0.02	0.011	2.05	0.040	0.001	0.045
cov(e.Var39_13,e.Var39_14)	0.06	0.010	5.92	0.000	0.038	0.075
cov(Employee & Organizational outcomes)	0.06	0.012	5.46	0.000	0.041	0.086
obs = 400; Estimation Method = ml; Log likelihood = -3378.5074 ; LR test of model vs. saturated: chi2(57) = 170.52, Prob > chi2 = 0.0000						

The above Table 9.24 gives information about how the model is specified by listing the observed variables in HRD Matrix mentioning with coefficient values of the *Employee Outcomes* ($\beta=0.029$) and *Organizational Outcomes* ($\beta=0.146\sim 0.150$) as two latent variables) respectively are competent & innovative employee ($\beta=1$, constrained), increases rate of HR development ($\beta=1.695>1$), commitment and performance ($\beta=2.346>1$), problem solving skill ($\beta=1.995>1$), better utilization of HR ($\beta=1.849>1$), higher satisfaction and motivation ($\beta=1.995>1$) and the latent variable (*Employee outcomes*). Similarly, the table shows information on how the model is specified by listing the observed variables with coefficient values of the latent variable (*Organizational Outcomes*) are generating internal resources ($\beta=1$, constrained), health & safety ($\beta=1.015>1$), greater teamwork ($\beta=0.923$ near to 1), higher productivity ($\beta=0.810$ near to 1), growth & diversity ($\beta=0.972$ near to 1), less turnover cost ($\beta=1.161>1$), higher profit ($\beta=0.631$), and better image ($\beta=0.670$).

The researcher has observed the standardized factor loadings because of the variance for *Employee Outcomes* has been set to 1 to scale the latent variable and for model identification. The standardized factor loading for the *said five* variables are >1.00 meaning that standard deviation increased in *Employee outcomes* leads to 2.346, 1.995, 1.849, 1.695 and 1.378 standard deviation increased in the response to the model. Therefore, it is the best measure of *Employee Outcomes in HRD Matrix fits*.

Similarly, the standardized factor loadings because the variance for *Organizational Outcomes* is set to 1 to scale the latent variable and for model identification. The standardized factor loading for the *less turnover cost and health & safety* variables are >1 meaning that standard deviation increased in *the two factors* leading to 1.161 and 1.015 respectively standard deviation increases in the response to the *Organizational Outcomes* in the model. The remaining all other factors are effective since coefficient values are near to 1. The test statistic value extremely significant ($p\text{-value}=0.000<0.05$) at 5% level of significance.

The model chi-square value, $\chi^2(57)=170.52$, Prob $>$ chi2 = 0.000, is highly statistically significant indicating the model reproduces the observed covariance among all factors very well. The null hypothesis (H_0) is that the model fits perfectly. The p -value of 0.000 is <0.05 , the typical cut-off for the test, which means that the null

hypothesis is rejected and the model fits well. With all of the model level fit measures taken together, the overall model fits extremely well meaning that the latent variable specified as *HRD process* and *HRD Climate or OCTAPACE* are strongly related to the all factors used to quantity it. The output also provides with the chi-square value of 170.52, with the degree of freedom 57, and the significance of the chi-square test (i.e. $p < 0.001$). Therefore, the equation may be $EM = f(\text{Employee Outcomes} + \text{Organizational Outcomes})$.

9.5.6 Structural Relationships and Path Coefficients of Organizational Effectiveness

Table 9.25: Hypotheses and path coefficients of organizational effectiveness

Hypothesized Structural Path	p-value	Coeff.	Relationship	Remarks
Motivation<- Employee Outcomes	0.000	0.029	H_{a1} ; accepted	Direct effect
Motivation<-Organizational Outcomes	0.000	0.150	H_{a2} ; accepted	Direct effect
Motivation<-Organizational Effectiveness	0.000	0.179	H_{a3} ; accepted	Direct effect

Therefore, it has been observed that all null hypotheses are rejected and alternative hypotheses are supported this is why there is a direct effect of employee and organizational outcomes or HRD Matrix on employee motivation of the sampled banks (Table 9.25). It has also been remarked that the *Beta* coefficient value of organizational outcomes is higher than employee outcomes.

Table 9.26: Correlation matrix of organizational effectiveness

Correlations						
		Organizational Outcomes	HRD Process	HRD Mechanism	OCTAPACE	Employee outcomes
Pearson Correlation	Organizational Outcomes	1.000				
	HRD Process	0.277*	1.000			
	HRD Mechanism	0.417*	0.385	1.000		
	OCTAPACE	0.274*	0.388	0.423	1.000	
	Employee outcomes	0.689*	0.249	0.355	0.258	1.000

It is being observed that there is a positive correlation between Organizational effectiveness and motivation. Employee outcomes is highly correlated ($r = 0.689^*$) in the matrix (Table 9.26).

9.6 Overall Impact of HRD on Employee Motivation

9.6.1 Study Hypotheses of Employee Motivation and Human Resource Development

To investigate the effectiveness of employee motivation and human resource development the researcher assumed the following hypotheses:

- H₀₁*: JCM factors have no significant effect on employee motivation in human resource development (HRD).
- H₀₂*: Financial benefits have no significant impact on the employee motivation in HRD.
- H₀₃*: Other monetary benefits have no significant outcome on the employee motivation in HRD.
- H₀₄*: Fringe-benefits have no significant effect on the employee motivation in HRD.
- H₀₅*: Leave benefits have no significant effect on the employee motivation in HRD.
- H₀₆*: Glass ceiling phenomenon does not have significant impact on the employee motivation in HRD.
- H₀₇*: Factors of QWL have no significant impact on the employee motivation in HRD.
- H₀₈*: Training and retention have no significant impact on the employee motivation in HRD.
- H₀₉*: HRD environment factors have no significant impact on the employee motivation in HRD.
- H₁₀*: HRD mechanism factors have no significant outcome on the employee motivation in HRD.
- H₁₁*: HRD process factors have no significant outcome on the employee motivation in HRD.
- H₁₂*: OCTAPACE have no significant effect on the employee motivation in HRD.
- H₁₃*: Performance appraisal (PA) factors have no significant impact on the employee motivation in HRD.
- H₁₄*: Management practices factor have no significant effect on the employee motivation in HRD of the banking sector.
- H₁₅*: Factors of organizational effectiveness (employee and organizational outcomes) have no significant effect on the employee motivation in HRD.

9.6.2 Normality Check for Employee Motivation

Multiple linear regression models should follow normality assumptions to fit the dependent variable. From the normality test table the Shapiro-Wilk test statistic value is 0.959~96% with *p*- value 0.000 (<0.05). The fitted histogram plot shown that the bell shaped curve, similarly the normal Q-Q (Quantile-Quantile; Figure 9.4 & 9.5) plot shown that the fitted line approximately passing throw the origin. Therefore, it may conclude that

the dependent variable *employee motivation* follow the normal distribution. In this regards, multiple regression model may use for further investigations.

Table 9.27: Normality test of dependent variable (Employee motivation)

Dependent variable	Tests of Normality			Remarks
	Shapiro-Wilk			
	Statistic	df	Sig.	
Employee Motivation	0.959	400	0.000*	The normality test satisfied for fitting Employee Motivation as a dependent variable in the multiple regression model.
*Significant at 5% level.				

Charts (Employee Motivation in the Banking Sector)

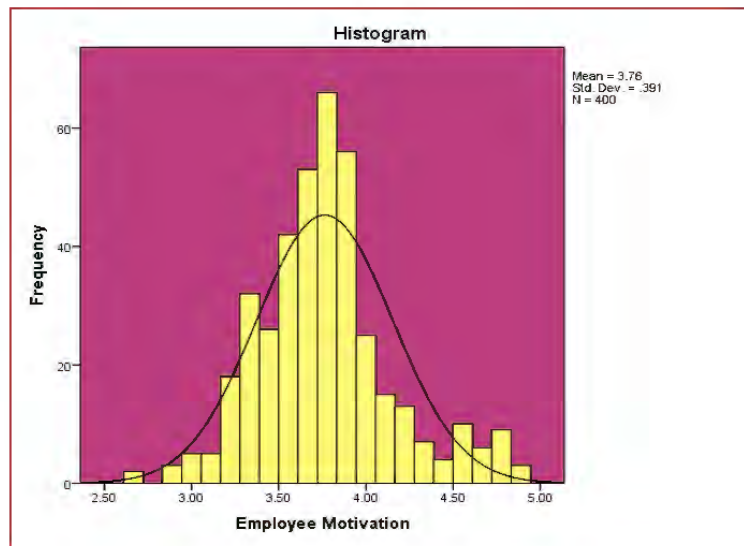

Figure 9.4: Fitted histogram for employee motivation

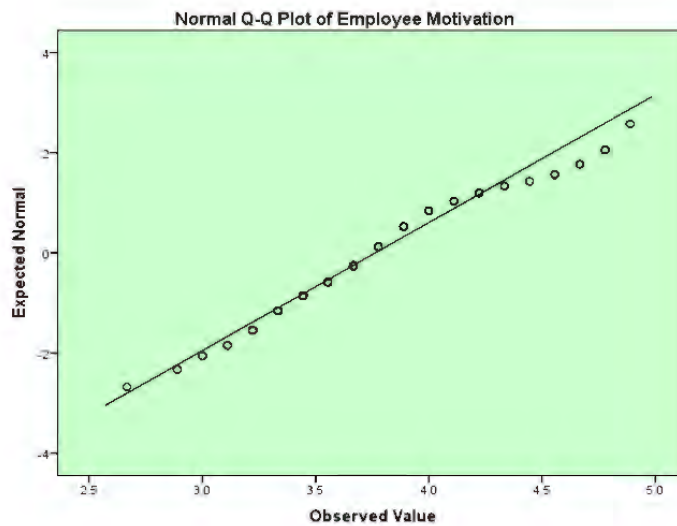

Figure 9.5: Q-Q plot for employee motivation

9.6.3 Dependent and Independent Variables of Employee Motivation

The employee motivation (EM) of the banking sector has been taken as dependent variable in the regression model. The regression model can be written as:

$$\text{Employee Motivation (EM)} = \alpha (\text{constant}) + \beta_1 \text{*JCM} + \beta_2 \text{*FB} + \beta_3 \text{*OMBs} + \beta_4 \text{*FBs} + \beta_5 \text{*LBs} + \beta_6 \text{*GC} + \beta_7 \text{*QWL} + \beta_8 \text{*TR} + \beta_9 \text{*HRD Env} + \beta_{10} \text{*HRD Mecha} + \beta_{11} \text{*HRD Pro} + \beta_{12} \text{*OCTAPACE} + \beta_{13} \text{*PA} + \beta_{14} \text{*Mgt Practices} + \beta_{15} \text{*OE} + e$$

From the above equation, α is constant, β_i 's are the regression coefficients of the explanatory variables, and e is the random error term (it follows normal distribution).

9.6.4 Investigation of Employee Motivation and HRD Model

Theoretical investigations have shown that independent variables are largely dependent on dependent variables. Besides, when the organizations are ready to provide the financial and nonfinancial benefits, fringe and leave benefits, practicing the job characteristics, training and development, performance appraisal, HRD matrix variables for organizational effectiveness, and co-ordinate for innovative team work by participating all can be observed frequently.

9.6.5 Multiple Relationships of Employee Motivation among the Constructive Factors

Table 9.28: Model Summary of employee motivation

Model	R	R Square	Adjusted R Square	S.E. of the Estimate	Change Statistics					Durbin-Watson
					R2 Change	F Change	df1	df2	Sig. F Change	
	0.708a	0.502	0.482	0.28155	0.502	25.778	15	384	0.000	1.822
a. Predictors: (Constant), Fringe Benefit, Organizational Effectiveness (Employee and Organizational), PA, Glass Ceiling, JCM, Leave Benefits, Mgt Practices, Other Monetary Benefits, Training and Retention, OCTAPACE (HRD Climate) HRD Environment, HRD Mechanism, HRD Process, QWL, HRD Process.										
b. Dependent Variable: Employee Motivation in the Banking Sector.										

Table 9.29: ANOVA^a of employee motivation

Model		Sum of Squares	df	Mean Square	F	Sig.
	Regression	30.652	15	2.043	25.778	0.000^b
	Residual	30.440	384	0.079		
	Total	61.093	399			
a. Dependent Variable: Employee Motivation						
b. Predictors: (Constant), Fringe Benefit, Organizational Effectiveness (Employee and Organizational), PA, Glass Ceiling, JCM, Leave Benefits, Mgt Practices, Other Monetary Benefits, Training and Retention, OCTAPACE (HRD Climate) HRD Environment, HRD Mechanism, HRD Process, QWL, HRD Process.						

Table 9.30: Coefficients^a of employee motivation

Factors of Employee Motivation	Estimated Coefficients		t-statistic	Sig.	95% Confidence Interval for β	
	Regression Coefficient (β_i)	S.E			LB	UB
Constant (α)	-1.044	0.367	-2.844	0.005	-1.766	-0.322
<i>JCM</i> (β_1)	0.174* (5)	0.039	4.404	0.000	0.096	0.251
<i>Financial Benefit (FBs: β_2)</i>	0.375* (1)	0.060	6.284	0.000	0.257	0.492
Other Monetary Benefit (OMBs: β_3)	-0.112* (9)	0.046	-2.456	0.014	-0.202	-0.022
Fringe Benefit(FNBs: β_4)	-0.032	0.029	-1.113	0.266	-0.089	0.025
<i>Leave Benefit (LBs: β_5)</i>	0.267* (3)	0.068	3.930	0.000	0.133	0.400
Glass Ceiling (GC: β_6)	0.049	0.041	1.211	0.227	-0.031	0.129
QWL(β_7)	-0.077	0.063	-1.227	0.221	-0.201	0.046
<i>Training & Retention (TR:β_8)</i>	0.162* (6)	0.062	2.628	0.009	0.041	0.284
<i>HRD Environment (HRD Env: β_9)</i>	-0.126* (7)	0.061	-2.070	0.039	-0.245	-0.006
HRD Mechanisms (β_{10})	0.100	0.116	0.862	0.389	-0.128	0.329
HRD Process (HRD Pro: β_{11})	-0.005	0.051	-0.090	0.928	-0.105	0.096
OCTAPACE (β_{12})	-0.056	0.095	-0.585	0.559	-0.243	0.132
<i>PA</i> (β_{13})	0.289* (2)	0.045	6.502	0.000	0.202	0.377
<i>Mgt Practices</i> (β_{14})	0.200* (4)	0.055	3.610	0.000	0.091	0.309
Organizational Effectiveness (<i>OE</i> β_{15})	0.118* (8)	0.053	2.215	0.027	0.013	0.223

*Significant at 5% level

9.6.6 Multiple Regression Analysis Results of Organizational Effectiveness

The coefficient of multiple determinations R^2 is ~50% variability on the employee motivation has shown in the model. Similarly, the adjusted value of R^2 highlighted that ~48% variability on the employee motivation can be explained by motivational factors as well as human resource development (independent variables). The Durbin test value is 1.822 (0 to <2.0) showing that there is positive autocorrelation between the variables of human resource management of the organization (Durbin and Watson, 1971).² The F-Test value is 25.778 among the variables and p -values are less than 5% for the data variables indicates the very well fit of the regression model analysis. *JCM*, *financial and other monetary*, *leave benefits*, *training and retention*, *HRD environment*, *Organizational Effectiveness (employee and organizational outcomes)*, *performance appraisal (PA)* and *management practices* are statistically significant since p -value <0.05 and contributing the significant effect to the employee motivation. Therefore, there is a significant impact on the employee motivation in the banking organization.

² James Durbin, and Geoffrey S. Watson, "Testing for serial correlation in least squares regression. III", *Biometrika*, 1971, 58 (1): 1–19. doi:10.2307/2334313.

9.6.7 Fitted Regression Model for Employee Motivation

The fitted of the regression model as shown from the Table 9.32. It can be written as the fitted following regression model as equation form.

The fitted multiple regressions model can be written as:

$$EM = -1.044 * (\alpha) + 0.174 * JCM + 0.375 * FBS * OMBs - 0.032 * FNBs + 0.267 * LBS + 0.049 * GC - 0.077 * QWL + 0.162 * TR - 0.126 * HRD Envi + 0.100 * HRD Mecha - 0.005 * HRD Pro - 0.056 * OCTAPACE + 0.289 * PA + 0.200 * Mgt Practices + 0.118 * OE$$

The β_1 coefficient findings are 17.4 % times positively influence of job characteristics model, on employee motivation. The coefficients results are statistically significant p -value is 0.000 and t-test statistic value is 4.404. Thus, H_{01} is rejected and it is inferred that the JCM factors have significant effect on employee motivation.

The β_2 coefficient findings are 37.5 % positively influence of financial advantages on employee motivation in the bank. But coefficient of these results is highly statistically significant at 5% significance level (p -value is 0.000). The t-value is 6.284, thus, H_{02} is rejected and it is inferred that the factors of financial benefits have significant impact on employee motivation as it is shown the positively.

The β_3 shows negatively 11.2% influence on the employee motivation, t-value is -2.456 and p -value (0.014) is significant at 5% significance level hence the null hypothesis (H_{03}) is rejected. Thus, there is a relationship between motivation and other monetary benefits.

The β_4 coefficient shows 3.2% influence of fringe benefits on the employee motivation, t-value is -1.113 and p -value is higher at 5% significance level (p -value is 0.266). Hence, H_{04} is accepted. Thus it is observed that in case of fringe benefits has indirect impact on the employee motivation.

The regression coefficient β_5 (Leave Benefit) which measures leave benefit has 26.7% influences on employee motivation of sampled employees. The t-value is 3.930 and p -value is <0.05 (p -value is 0.000) significance level. Hence H_{05} is rejected.

The regression coefficient β_6 is 4.9% positively influence of glass ceiling on employee motivation in the banking sector. The t-value 1.211 and p -value are not statistically significant at 5% significance level (p -value is 0.227). Hence H_{06} is accepted.

The regression coefficient β_7 is 7.7 % of QWL negatively effect on employee motivation in the banking sector. The t-value -1.227 and p -value are not statistically significant at 5% significance level (p -value is 0.221). Hence, H_{07} is accepted.

The regression coefficient β_8 is 16.2% of training and retention positively influence of on employee motivation in the banking sector. The t-value 2.628 and p -value is <0.05 (p -value is 0.009) which is statistically significant. Hence, H_{08} is not supported.

The regression coefficient β_9 is 12.6% of HRD environment negatively effect on employee motivation in the banking sector. The t-value is -2.070 and p -value is <0.05 (p -value is 0.039) significant level. Hence, H_{09} is not accepted.

The regression coefficient β_{10} is 10.00% of HRD mechanism which positively affects employee motivation. The t-value 0.862 and p -value is higher than 0.05 (p -value is 0.389) which is not statistically significant at 5% significance level. Hence, H_{10} is not rejected.

The regression coefficient β_{11} is 0.5% of HRD process which negatively affects the employee motivation in the banking sector. The t-value -0.090 and p -value is not statistically significant at 5% significance level (p -value is 0.928). Hence H_{11} is accepted.

The regression coefficient β_{12} is 5.6% of OCTAPACE that negatively influences the employee motivation in the banking sector. The t-value -0.585 and p -value is >0.05 which is not statistically significant at 5% significance level (p -value is 0.559). Therefore, H_{12} is accepted.

The regression coefficient β_{13} is 28.9% positively influence of performance appraisal (PA) on employee motivation in the banking sector. The t-value 6.502 and p -value less than 0.05 (p -value is 0.000) which is statistically contributing significance associated with HRD. Hence, H_{14} is rejected.

The regression coefficient β_{14} is 20.0% of management practices (Mgt practices) which positively influences the employee motivation. The t-value 3.610 and p -value is <0.05 (p -value is 0.000), which statistically significant at 5% significance level contributing to HRD and motivation. Hence H_{05} rejected.

The regression coefficient β_{15} is 11.8% of organizational effectiveness (OE) positively influence of employee motivation in the banking sector. The t-value 2.215 and p -value is less than 0.05, (p -value is 0.027) which is statistically significant. Thus, H_{13} is rejected. Finally nine hypotheses have significantly been proved.

9.6.8 Overall Results of Hypotheses Matrix (Employee Motivation)

Table 9.31: Hypotheses matrix

Hypotheses	Result	Impact/Effect on EM
H_{01} : JCM factors have no significant effect on employee motivation in human resource development (HRD).	$p=0.000$ Rejected	JCM does have impact on employee motivation
H_{02} : Financial benefits (FBs) have no significant impact on the employee motivation in HRD.	$p=0.000$ Rejected	FBs have more impact on motivation in the banking sector
H_{03} : Other monetary benefits (OMBs) have no significant outcome on the employee motivation in HRD.	$p=0.014$ Rejected	Employee motivation significantly influenced by NFBs
H_{04} : Fringe benefits have no significant effect on the employee motivation in HRD.	$p=0.266$ Accepted	Having no impact on motivation in terms of fringe benefits
H_{05} : Leave benefits (LBs) have no significant effect on the employee motivation in HRD.	$p=0.000$ Rejected	LBs show more effect on motivation
H_{06} : Glass ceiling (GC) phenomenon does not have significant impact on the employee motivation in HRD.	$p=0.227$ Accepted	Having no influence on motivation in case of GC
H_{07} : Factors of QWL have no significant impact on the employee motivation in HRD.	$p=0.221$ Accepted	Having no impact on motivation regarding QWL
H_{08} : Training and retention have no significant impact on the employee motivation in HRD.	$p=0.009$ Rejected	Observed significant effect on motivation by training and retention
H_{09} : HRD environment factors have no significant impact on the employee motivation in HRD.	$p=0.039$ Rejected	Found significant impact on motivation in case of HRD environment
H_{10} : HRD mechanism factors have no significant outcome on the employee motivation in HRD.	$p=0.389$ Accepted	No impact of HRD mechanism identified in motivation
H_{11} : HRD process factors have no significant outcome on the employee motivation in HRD.	$p=0.928$ Accepted	HRD process does not have impact on employee motivation
H_{12} : OCTAPACE have no significant effect on the employee motivation in HRD.	$p=0.559$ Accepted	No effect is being observed by OCTAPACE or HRD climate

<i>H₁₃</i> : Performance appraisal (PA) factors have no significant impact on the employee motivation in HRD.	<i>p</i> = 0.000 Rejected	PA indicates more concern in motivation
<i>H₁₄</i> : Management practices factor have no significant effect on the employee motivation in HRD of the banking sector.	<i>p</i> = 0.000 Rejected	Management practices do have the impact on motivation
<i>H₁₅</i> : Factors of organizational effectiveness (employee and organizational outcomes) have no significant effect on the employee motivation in HRD.	<i>p</i> = 0.027 Rejected	Organizational effectiveness does have the more impact on motivation

Employee motivation is a crucial issue in influencing the behaviour of people in the banking organization. With a view to confirming employee motivation the JCM, financial, non-financial, leave benefits, training and retention, HRD environment, HRD outcomes for organizational effectiveness, performance evaluation and management practices have the significant effect. Therefore, it can be concluded that there is a significant association between employee motivation and human resource development in the banking sector of Bangladesh.

9.7 Discussion on the Findings

HRD practices in terms of employee outcomes of the both banks showed the good figure and almost same between the banks. Better satisfaction found regarding competence, innovation, HRD rate, quality performance, problem solving, and proper utilization of resources in the banks. There are two factors with Eigenvalues of employee competent, HR development rate, image and generating internal resources were highly loaded and variance explained this is why there may retrace for higher level of employee motivation.

Team work, higher productivity, growth diversity, reduced cost, higher profit, better image and health and safety environment significantly influence the organizational effectiveness of HRD matrix observed in the banking organization. These factors' average values are more than 4.0 (true level of perception). That means organizational outcomes showed the good practices in the banks. It is being observed that there was a positive relationship between organizational effectiveness and motivation. Employee performance results are highly integrated into the matrix ($r = 0.689 *$).

According to two latent factor viz. *Employee Outcomes* ($\beta=0.029$), rate of HRD, commitment and performance, problem solving efficiency are the most effective factor. And the same way of *Organizational Outcomes* ($\beta=0.146\sim 0.150$), lower turnover cost was the most effective factor. It has been confirmed in the banks that there is a direct effect of organizational effectiveness (employee and organizational outcomes) on the employee motivation. Along with JCM, financial, non-financial, and other financial benefits, leisure benefits, training and retention, HRD environment, organizational performance, HRD results, performance appraisal and its impact on staff motivation to follow management procedures.

Thus, the banking sector in Bangladesh can further consider the practice of motivation theories with HRD matrix for better performance of existing employees so that the sector can survive nationally and globally in a competitive field.

As management is essential to the management of any organization, so motivation is needed for banks' success itself. Motivation is a process of influencing employees to work hard. This creates impulsiveness among the existing employees. In fact, running a banking organization requires different types of people, money, materials, machinery, sophisticated technologies, market etc. The human component is the most important material of these elements. It is proved that no work can be extracted from the employees by force. Bank may fail to achieve its goal if the employees voluntarily and selflessly dedicate themselves to the work. However, lack of motivation leads to loss motivation, low morale, increase workplace conflict, decreased productivity, and dissatisfaction with work. The employees make management uncooperative instead of cooperation as well. This kind of situation is very harmful for any organization. The cooperation of the staff is essential and essential for achieving the institutional goals. The motivated staff is dedicated to the assigned duties. As a result, waste is reduced. They are loyal to the managerial decision and welcome to the changes for developmental initiatives. Motivation awakens the sincerity and affection of the employees towards the organization. As a result, they contribute the most to the achievement of the goals of the banks.

Chapter Ten

Discussion and Conclusion

When employees are satisfied it helps to ensure the achievement of organizational goals. However, with the institutional development, there is an expectation of new opportunities among the employees. Apart from this, new expectations and shortcomings are born due to various reasons. As a result, the motivation process is followed again at another stage and efforts are made to improve morale by increasing work satisfaction. This is how it rotates. Various factors of satisfaction, facilities, job nature, HRD environment, HRD climate, HRD outcomes and organizational effectiveness influence the employee motivation in the banking sector. This chapter has focussed on key findings, suggestions, a proposed 'strategic management approach to practice job satisfaction-employee motivation' and recommended the theoretical and empirical contributions for further study.

10.1 Key Findings

There are two main components to any organization. One is mechanical/ technical the other is human. The main goal of the organization is achieved through proper co-ordination between these two elements. The second element of the banking organization i.e. the human element is called the life force or the main driving force of the all operations. It is very difficult to get performance done by keeping this material to satisfy the overly sensitive issues. The key findings of this study have been highlighted below:

The significant components observed, that employees feel negative feeling like-loaded working hours, stress, lack of promotion and transfer, scarce of autonomy or participation, lack of motivation for executives, less concentration on task significance and task identification and also immediate feedback, identity by designation, lack of advancement and growth as well as recognition, besides transportation facilities not enough. These are being performed to create some barriers in the mind of existence employee as well as the better performance of bank. The factors do have significance effect on employee motivation and also for employee development through the success of bank in the competitive arena.

The financial issues are being provided by the banks. These may ensure the satisfaction and motivated to the presence employee of the bank and get better with globalized world and also competitive market in this sector. The financial benefits have been specified namely allowances, bonuses, increment facilities, profit sharing, GPF, CPF, accidental benefits, transportation cost, medical facilities, launch allowances.

Besides having those facilities, the bank also provided some strategies for extra facilities. Those are in the bank- paternity leave, maternity leave, study leave, mandatory leave, sabbatical leave, occasional leave, recreational leave. This study identified the factors and had better interaction on employee motivation performed running the banking industry with adopted competitive business thought. The basic features are, about job rotation, close supervision with the existence workers, well decoration in workplace (OWL), making succession plan, taking organizational development initiatives with positive change (OD initiatives), discrimination, delegation of authority, assigning in the vital post for both male and female, more transparent in role clarity. These factors play the vital role on employee motivation and HRD in the banking sector and increase the organizational outcomes and effectiveness.

After investigating selected areas of the study, the work concerned to the environment both internal and external elements viz. organizational HRP, banking policies, management process, practices of HRD, HRD climate in the banking sector. The study found some effective factors influenced and performed to enhance organizational outcomes and to sustain the existence with the competitive financial business through the corporate strategies.

The two factors such as mechanisms of PA and HRD as an unit in HRD Mechanisms of the HRD Matrix are highly loaded by total variance explained, in the HRD Process there was one factor loaded, again it observed that there are two loading factors i.e., confrontation (C) and openness (O) personality covered the HRD climate or OCTAPACE. It has been observed that two factors- competent & innovative and HR development rate are the high loadings performing by banks' employees. On the other hand, better image and maximizing internal resources involved in organizational outcomes are the high loading factors. Employee outcomes and Organizational outcomes (organizational effectiveness) are highly correlated and have the significant

effect on employee motivation. Individual outcomes are highly correlated in HRD matrix. Overall, these two latent factors (employee and organizational) confirmed that risk taking fair rewards, role playing and analysis, committed performance are the effective factors in case of organizational effectiveness of the banking sector.

It has been noticed that two reasons- capable and innovative and the rate of HR development is that the employees of the banks are high loadings. On the other hand, due to the high loading that maximizes the internal resources involved in better image and organizational results. The study also found few features regarding, nature of bank, glass ceiling, lack of diversification, lack of innovation, committed in working. These do have influential arena in related financial or banking industry. The specified factors have the greater impact on employee motivation and human resource development to sustain the organization with civilized and competitive world in the banking industry of Bangladesh.

10.2 Suggestions

The Human Resource Management Department of the organization is closely related to the existing employees and a manager named HR Manager is in charge of this department. His/her job is to surround human resources. Therefore, human resource managers have to possess a number of special qualities that make it easier to manage human resources and employees. The followings are the measures for improving the HRD environment that directly and indirectly influence employee motivation in the banking of Bangladesh:

Judging and analysing the qualities required to perform the duties assigned to the employee, it is determined that knowledge, skills and attitudes need to be developed in those areas.^{1,2,3&4} This will reduce the rate of waste and loss of the banks.

¹ William McGehee, and Paul W. Thayer, *Training in Business and Industry* (New York: John Wiley & Sons, 1961).

² T. Boydell, and M. Leary, *Identifying Training Needs (Training Essentials)*, (UK: Chartered Institute of Personnel & Development, 1996).

³ Elwood F. Holton Iii, Reid A. Bates, and Sharon S. Naquin “Large-Scale Performance-Driven Training Needs Assessment: A Case Study”, *Public Personnel Management*, 2000, Vol. 29(2): 249-67.

⁴ Kamila Ludwikowska, “The effectiveness of training needs analysis and its relation to employee efficiency”, *ZESZYTYNA UKO WEPOLITECHNIKIPOZNAŃSKIEJ*, 2018. DOI: 10.21008/j.0239-9415.2018.077.11.

Participation in different decision making of the female employees should increase than the earlier ones. Female employees should be more conscious to come forward enthusiastically with the different events and options.

Maternity leave and child care unit should be retraced. Female can leave the station after 6.00 pm as the Bangladesh Circular. Due to family responsibilities a women cannot do job like a man does, this case could be resolved by the female through taking day care facility for their babies during the working hours so that they (female) can be free of tension.

In today's era of globalization, huge competition among business entities is on the rise. Banks need more efficient human resources to survive in this competition. Therefore, in order to build efficient human resources, more emphasis must be placed on human resource planning. It is not possible to supply the right number and quality human resources at the right time without proper human resource planning. In the current globalization, management techniques are constantly changing due to manpower diversification and technical reasons. In line with these changes, it is possible to provide skilled and qualified staff if effective human resources are maintained in the banking organization. By analyzing the organizational behavior of the employees of the banking industry, it is possible to determine in which cases the training of the employees is required, which will reduce the cost of training.

The tick mark can be used in relation to the lower ranks of the employees, personal development, relationship with the management, remuneration and technical knowledge, management control and knowledge about the bank etc. In this case, it requires the knowledge management (KM) to optimize the organization's design and workflow. KM's vision and approach can be considered essential for adopting the KM strategy. Alignment between organizational, HRM and KM strategies, a key element of organizational management in the age of knowledge. So, in order to drive KM as a strategy need to understand how banking industry view KM.⁵

⁵ Hadi El-Farr, and Rezvan Hosseingholizadeh, "Aligning HRM with Knowledge Management for Better Organizational Performance: How Human Resource Practices Support Knowledge Management Strategies", 2019 DOI: 10.5772/intechopen.86517

It is often the case that no action is taken in the case of positive motivation. Again, there is no system to reward negative motivation. Management has to resort to negative motivation only when positive motivation fails to bring any benefits to motivate the employees in the work. It is easy to say that management has to decide what kind of motivation to resort to considering the time, environment and situation and the behavioral differences of the existing employees. When in the same situation and in the context of performance, the management should aim to treat every employee in the same way.

The authority of the banking industry includes some special benefits which include providing extra-time staff which does not directly improve the financial condition but increases the attractiveness of the person's job or position. These benefits are related to office equipment, status facilities, driver, peon, parking, decoration of desk and chamber, cleaning, uniform, washroom, visiting card, big table, personal assistant etc. As a result, they can increase the quality of work by self-employment and special non-financial rewards can be given for their loyalty and create a sense of responsibility towards the organization.

Motivation is to motivate the employee to perform. Different types of stimuli can be used to motivate action. These stimuli are related to filling deficiencies. Providing motivation creates a strong interest in the mind of the employee to work hard. Therefore, the employee tries to apply the lowest possible support in every job, which ensures his/ her high level of performance and contribution. Performance is the level of productivity or work of an employee. It depends entirely on the employee's interest and desire for work. There are three important issues involved with the work ethic of an employee in the workplace. These are the ability (A) of the employee, motivation (M) and performance (P) of the employee. A link between the three subjects can be noticed.

Employee ability refers to do any performance of the employee. Every employee employed in the workplace has less ability and it is because of this ability that is engaged in work. In order to get work from the employee, it is important to support the motivation with the help of performance. By motivating the employee properly, it is possible to make full use of his / her potentialities. Banking industry can concentrate on the better performance of employees through the outcomes of HRD.

It can be seen that there is an interdependent relationship between ability, motivation and performance. Ability is the power of action and motivation, so action uses this energy to the maximum. Through performance, the management is able to achieve human resource development and institutional objectives by determining the value of the employee. Therefore a proper performance appraisal program is essential for human resource development. In this case requires consulting with supervisors, managers of the branches and association representatives, designing development program.

Training is a strategy to increase the knowledge and skills of the staff. The need for training is determined on the basis of the purpose of the banking organization, the nature of the work, the type of employee and the qualified facilities. The training requirements are determined by analyzing the nature of work of all the officers and employees employed in a bank. The demand for training is determined by focusing on human resource planning (HRP) in the banking industry. It is also necessary to consider the cost of training, the resources required to provide the training and whether there is skilled training.

Women workers must be proactive in every branch to arrange baby care to take care of their young children. In the absence of this, women officers are often forced to quit their jobs like in banks. They may not be able to concentrate at work because they are always worried. Therefore, it is very important to take necessary steps in this regard.

Behavioral changes are needed to motivate employees, especially in public sector banks. There is a need to be more humble with the clients so that the bank can face the difficult challenges in this complicated banking business which will help in achieving its interests. Those concerned need to come forward in this regard.

The banks need to create the necessary supportive culture environment, including behavioral change, to motivate employees more. In this case, banks have to pay attention to all aspects. Always be ready.

All logistical support must be provided to all employees. It requires co-operating each other. Different types of drives or events such as MBO, MBE, MBF, MBD etc. can be arranged at different times to solve different problems.

In the era of free market economy and globalization, management development is an essential issue to meet the competition of the banking corporation in developing countries like Bangladesh. Unskilled employees and managers are a common occurrence in the public financial institutions of Bangladesh. The state-owned banks of the country are constantly conducting business with the burden of losses on their shoulders. Therefore, the issue of management development in Bangladesh is being widely observed everywhere. In this case, the banks can maintain more collaboration with BIBM, BMDC, BIHRM, IBA, ICMAB, ICAB, BPATC, NAEM, RDA, BARD, universities etc. These programs may be enhanced the continuous improvement of the banks.

Employee training requirements can be determined by analyzing employee productivity. As a result, it is possible to determine the relationship between the low cost and high cost. At the same time, it is necessary to find out the possibility of immediate change in the adopted technology and technical issues and the need for training in line with any change in the future transaction systems. A special attention like this is suggested to nationalized or state-owned banks of Bangladesh.

Banking institutions can focus on job analysis to determine exactly what kind of work an employee needs to do, how to do it, and what kind of skills and qualifications are needed to get the job done properly. So the success of task analysis depends on the right direction information. It is necessary to continue research on it. Satisfaction would be easier if one could determine the relative value of each task separately by comparing it with other tasks through job evaluation.

The scope of activities of modern large-scale banking business is very widely and wide. As a result, various problems arise due to problems in staff management and organizational complexity. There has been a conflict among the young employees since 2008 due to postpone the GPF facilities. They are depressed for GPF and FBAR facilities. Employees can raise objections or demands to the management in order to eliminate and solve these problems. Therefore, any objection or dissatisfaction expressed by the employees to the management regarding the work, working environment, conditions of work, compensation, or salary-allowance, benefits, transfer

and promotion, seniority, leave, breach of contract, and unfair treatment etc. should be taken into consideration.⁶

In HRD planning and policy, there should be preserved some activities i.e., managerial ingenuity, acquisition of personality, required knowledge, ability to develop the human virtues coordinated about the ability or skills of manager/ employee. For this reason, the behavior of manager is analyzed by mental structure, physical efficiencies and these are considered to ensure the necessary actions as well. HRD is basically related to the individual development of employees especially for bank managers. HRD is more concerned with looking forward for future and it is better than training related to education which helps to develop on employee to take right decision. This reason signifies the banks and their human resources a principal factor of the organization.

In general, presently business concept is changing day by day in competitive world. The concentration about balanced strategies to adapt the changing condition is to know about the method of HRM frequently. It can be presented and categorized the experience through HRD process. As a result, an HR manager of each bank does have the ability to handle the challenges successfully.

It is necessity to ensure the return of the organization in terms of technical, technology, and also for social changes. Political and technical knowledge of the manager can be increased through development of HRM. Bank should be given priority and considered on employee motivation in the banking industry and employee development to sustain the organization in long run with modern technological world.

HRD plays a significant role creating skilled manager in achieving objectives and goals of the organization through the coordination of the organization's overall materials and efficient management and control.

HRM enhances the efficiency of the managers that it brings working experiences to the development of manager's work. It is helpful to develop the efficiency about the new sophisticated technologies and technical knowledge to sustain in the huge

⁶ ILO Conventions, *The Reduction of Hours of Work (Public Works) Convention*, 1936 (No. 51), and the *Reduction of Hours of Work (Textiles) Convention*, 1937 (No. 61).

competition of the banking sector. HRM plays a vital role in importing the overall efficiency of the organization through the development of individual skills.

HRD managers do not only provide ideas about many reliable things in modern world. Having many qualities – who are involved in management of work force having much quality as well. That's why; managers do have knowledge and skills regarding human resource policies, HRD, and HRD climate (OCTAPACE culture or eight cultures) also which suggest enriching the practical way of life in the banking sector of Bangladesh.

HRM does not prevent the development of managers' old ideas. Awareness of modern technology, technical knowledge and manager tries to get latest news. In terms of public and specialized bank like RAKUB provided more attention which does not have updated technology especially on rural branches and suggested to adopt the facilities of the sophisticated technology within the shortest possible time.

HRD increases the skills of managers and creates interest to perform his/her job perfectly. This idea leads to improve working behavior. Concerned authority of the banks should come forward how attain the more satisfaction among the existing employees.

An HRD manager builds an efficient executive reservation. Continuous management development is essential for expansion of future demand it goes for further extension of organization. HRM plays a vital role in the development of managers through creating complexity of works and by training to increase the volume of efficient employees. This type of total quality management (TQM) should practice by the banks for continuous development.

Many scholars have identified human resource development as the main objective of human resource management. In conclusion, human resource development refers to the overall effort to develop their functional skills and abilities as well as to provide them with mental excellence and proper environment in order to achieve the expected work and behaviour from the manpower employed in the organization. In this case, effective quality training is considered very important in the development of skills.

HRD institutes to create the opportunities for ensuring the regular activities. This ensures the flexibility on the workplace since the banks develop innovative practices. That's why; a complete R&D department should establish in the banking organization structure. It can be noticed the procedural of the R & D of the Bangladesh Bank in the country. Respective bank should follow the policies established by Bangladesh Bank so that deficiency in the goal achievement be fulfilled. That's why; it is required to review continuously on HRD instruments and job feedback. It makes the managers efficient by which organizational goals can be obtained. Knowledge and information about updated technology and procedure enable the banks' performance to ensure optimal use of machinery and raw materials as well. As a result, the level of productivity increases and reduces the cost of production. HRM and development programs should be continued in the nationalized and private banks for achieving ultimate output with the fullest possible way. Staff meetings of each branch of the banks should be encouraged and explore the key problems.

Good employee/ labor management relations are more dependent on the success of an organization. HRD creates a harmonious relation among the employees by reducing the conflicts of the organization.⁷ Since work dissatisfaction and absence of action deteriorate the brilliant relationship between management and employees.

HRD reaches its target in the face of developing business complexity and intense to competition worldwide. Therefore, to face challenges in the field of corporate operations HRD can be applied extensively by increasing knowledge, skills, performance (KSA) of the existing employees to sustain the bank successfully in the competitive market. HRD Department should be well equipped with a full pledged of brilliant and qualified HR executives.

The study has suggested confirming policy implication in case of HRD outcomes, HRD climate, individual outcomes, performance and seniority based promotion, proper strategic HRM as well as organizational effectiveness practices. These empirical practices which lead to increase the level of employee motivation in the banking sector.

⁷ James T. Shotwell (ed.), Final Texts of the Labor Section', *The Origins of the International Labor Organization*, October 1994: 424- 449.

Awareness of the importance of the human side of the banks should be considered as a functional requirement of any dynamic and growth oriented initiative. There should be adequate recognition for the work done in the management of the bank. When an employee innovates a bank should find out the ways to recognize for virtuous performances immediately.

The researchers found that the overall glass ceiling phenomenon of public banks was higher than that of private banks. It should be concluded that identifying the availability of sampled banks can re-evaluate the three factors by determining particularly important assignments, inequality in DoA and prospects for advancement for female employees thereby increasing employee satisfaction and motivation. This is why; female employees are relegated to the banking organization.

It has been noticed that employee promotion and transfer policy greatly affects employee satisfaction and motivation. The bank authorities or HR professionals may consider the benefits of the overall limitation where study leave, more occasional leave and other leave policies. Since banking activities are now a challenging problem this is why the HRD department or HRD's strategic unit can develop the nature of work as well as enrich existing employees to avoid feedback. On the other hand, the situation of challenges for bank employees to survive in the competitive arena should be considered. The principles of taking responsibility for work should be divided for satisfaction and inspiration.

Banks need to pay special attention to the development of manpower, methods and technology to improve productivity. The development of productivity will be facilitated only if the working environment, transparency and accountability in all areas can be ensured for productive development in the banking sector.

Eventually it may be concluded that employees do not always chase after money. In such a situation, financial incentives cannot play a role in motivating. In this situation, various steps have to be taken to motivate the workers for job recognition, participation in democratic management, job security, fair work environment, good behaviour, proper training facilities, professional development etc. On the one hand, the banks have responsibilities towards the employees and the employees must be aware of the responsibilities and duties towards the organization.

Nowadays, the importance of managerial efficiency and efficiency in large scale business organizations is immense that influences organizational behavior. As a result of efficiency and effectiveness, formal and informal communication is established between the manager and his/her subordinates. This results in the development of a management relationship with all concerned. Existing employees can easily perform their duties. It is easy to coordinate each task in different departments or branches. This reduces the waste and expenditure of resources and the employees are easily motivated. As a result, dissatisfaction, doubts and disputes are removed and friendly relations prevail.

Presently due to the *corona virus* epidemic, the stress of being infected by a *deadly virus* and the fear of reduced pay has increased alarmingly among all employees. Recently many private banks have decided to retrenchment, stoppage of work, lay-off strategies in the work as well as in Bangladesh.⁸ It is an important and challenging issue in present world because globalization has been creating a competitive and beneficial organization by transforming HRD since its commencement. HRM is very much important to adopt the situation at present world which completely depends on human resource in globalized world. The concepts of HRD and HRM are being extremely enlarged day by day for creating the borderless market all over the world. HRM is made as a fundamental or basic task of an organization by knowledge and managerial strategies. This is why; developing and under developing countries are being tried to manage their human resources considering the essential resources. Success cannot be achieved if there is no ideology, no group, no political theory can win greater output by applying less than a given complex of human resources without taking proper action. In this regard the policy maker contributing to the HRD of this sector for ensuring individual performance so that the existing employees can obtain the goal of different banks which could be helpful to sustain globally.

In inclusion, it can be said that people (HRs) are active because they have motivation. Motivation motivates employee to take responsibility. As a result, the whole organization gained momentum. The same way, bank is able to reach its goal easily. Motivation in modern management is therefore called the lifeblood of proper management.

⁸ Financial Express (FE) Report, "Workforce Reduction during Covid-19: Information for Employers, *The Financial Express Report*, March 30, 2020.

10.3 Proposed ‘Strategic Management Approach to Practice Job satisfaction- Employee Motivation’

The present study proposed a sequential ‘strategic management approach to practice Job satisfaction-employee motivation’ after gaining the theoretical and empirical knowledge about job satisfaction and employee motivation for the banking sector in Bangladesh. The proposed approach comprises of six phases as depicted in the Figure 10.1:



Figure 10.1: Proposed ‘strategic management approach to practice job satisfaction-employee motivation’

1. **Job Satisfaction Level:** This phase consists with measuring the existing motivation level of the employees at a regular interval set by the authority concerned and reports are to be prepared using the tools like cross-team, reports (ACR), consultation, survey, observation among others as need are unlimited, satisfaction varies time to time therefore settle new motives among employees even after motivation been paid off recently.
2. **Necessity of Motivation:** In this phase, authority judges the degree of motivation needed to satisfy employee motives aroused among employees in individual and

group level. This phase requires an investigation of the motivating factors in a settled scale through the tools used in the previous phase.

3. **Planning:** This phase starts with gaining knowledge about the elements of existing HRD matrix includes the employees status, working structure, job responsibilities, leadership style, chain of command, working environment or climate with the same tools used before and assistance of the HRD department to prepare a updated mapping of HRD matrix. The authority concerned considers financial asset and capacity to implement the prom accordingly.
4. **Organizing:** In this stage, the authority confirms the dimensions, techniques, on the process constraints and challenges to accomplish the roadmap designed in the previous phase. The motivation issues such as intrinsic and extrinsic to be clarified so as to confirm the mechanism to be set towards motivational program. Number of phases, categories to be set depending on the degree of motivation needed discussed in the phase two. Hierarchy of programs and implementing human forces accordingly to be finalized in this phase.
5. **Implementation Phase:** Implementing the motivational program the organized activities, tools and techniques and human forces needed to be integrated to complete the tasks. Supervision and monitoring system to be activated during the total implementation phase.
6. **Motivated Behavior:** At the final phase, consistency of the motivated behavior needed to be monitored at a regular interval and process reports dully through the hierarchy of the organization. Tools and techniques of the phase 1 and 2 to be applied to continue the process.

At each phase, internal and external environment to be considered as they influence in all the phases of the process to achieve motivated behavior of the employees. Influential factors may include financial base of the organization, knowledge of employee expertise, efficiency, capable to contribute in gaining goal, competency level, code of conduct, chain of command as well as leadership practices. In this case, the content based theories such as reinforcement, goal setting, expectancy as well as equity theory of motivation to be applied. The organization needs to look for the reasonable causes for motivation so that it

can be settled down the different tools and strategies with flexibility and eventually the banks can introduce the motivation process in practice.

10.4 Future Research Opportunity

The differences that occur in other areas in the application of the elements of motivation theories will be of little bit helpful in the analysis of cross country, time, material analysis, banking sector as well as in policy making. HRD practice can lead to policy making of any organization or rearrangement or modification of the HRD environment. HRD issues in the banking sector will again have a positive impact on academic enrichment.

In addition to government and non-government organizations, there are several foreign-owned companies in Bangladesh. Apart from the local organizations, a large part of the total employees are the officers and employees of these organizations. The work environment, salary structure, working conditions etc. of each organization are different. Therefore, it is typical for the employees working in such organizations to have different levels of job satisfaction and motivation. Further research can be done on the working environment, HRD climate, salaries – allowances, and other related issues these organizations. Further research theories can measure the level of motivation using a variety of issues or studies in other sectors such as private, public and multinational organizations. Consequently, cross-country research can be done by using other issues of the bank on a large scale. The study focuses on quantitative analysis only. More research can be done on qualitative analysis for further which has been suggested in the study. In recent world, employee motivation is more signified by the different societies of HRs. The positive response of motivation from the different corners of the world has been ensured in this study. Although, many scholars carried out their studies on motivation from different organizations in home and abroad but some of the study was done based only on single issue. This study will help the researchers around the world in conducting the relevant research on the identified motivation theories along with HRD practices. Theoretically, this study expands motivational research by constructing the concept for application. An attempt was made to identify the criteria for research and policy makers to work with employee motivation. Therefore, with a few adjustments, the results of the study can be replicated in other agencies and industries considering the proposed model of similar nature.

Bibliography

Books

- Adams, James Stacy. "Inequity in Social Exchange." *Advances in Experimental Psychology*, 1965.
- . Inequity in Social Exchange. In L. Berkowitz Ed. New York: Academic Press, 1965.
- Ali, M. Omar. *Essentials of Human Resource Management*. 3rd ed. Rajshahi: Writer, 2009.
- Anguinis, Herman. *Performance Management*. 2nd ed., New Delhi: Pearson India Pvt. Ltd., 2011.
- Aswathappa, K. E. M. A. L. *Human Resource Management: Text and Cases*. Tata McGraw-Hill Education, 2013.
- Atkinson, John William, and Joel O. Raynor. *Motivation and achievement*. Winston, 1974.
- Attorney, A. "Performance Appraisal Handbook." New York: Nolo Publishers, 2007.
- Babbie, E. *The Practice of Social Research*. California: Wardsworth Publishing Company, 1992.
- . "The Practice of Social Research." (2007).
- Bartol, Kathryn M. and David C. Martin. *Management*. 2nd international ed., New York: McGraw Hill Inc. 1994.
- Beer, Michael, Richard E. Walton, Bert Spector, Paul R. Lawrence, and Daniel Quinn Mills. *Human resource management: a general manager's perspective: text and cases*. New York: Free Press; London: Collier Macmillan, 1985.
- Berelson, Bernard, and Gray A. Steiner. *Human Behaviour*. New York: Harcourt, Brace & World Inc. 1964.
- Berkowitz, I. *Advances in Experimental Social Psychology*. New York: Academic Press Inc., 1965.

- Bhattacharyya, Dipak Kumar. *Human Resource Planning*. New Delhi: Excel Books, 2006.
- Bhuyan, Kartick Chandra. *Multivariate Analysis and Its Applications*. Kolkata: New Central Book Agency (P) Ltd., 2005.
- Billimoria, Rustam Poncha, and N. K. Singh. *Human Resource Development: A Study of the Airlines in Asian Countries*. New Delhi: Vikas Publishing House Private, 1985.
- Boydell, T., and M. Leary. *Identifying Training Needs (Training Essentials)*. UK: Chartered Institute of Personnel & Development, 1996.
- Brooks, Johnson. *Training is a Case of Stress Management. Stress and Rest Stress and Rest* (QouteMater.org).
- Byars, Liod L., and Rue, Leslie W. *Human Resource Management*, 7th ed. USA:McGraw Hill International Edition, 2003.
- Castello and Zalkind. *Psychology in Administration*. Englewood Cliffs: Prentice Hall, Inc., 1963 <https://doi.org/10.1002/hrm.3930020409>.
- Child, Dennis. *The Essentials of Factor Analysis*. 3rd edn. New York: Continuum, 2006.
- Chowdhury, Azad Kalam. *Manabsampad Byabosthapon*. Dhaka: GronthaKutir, 2011.
- Cochran, William G. *Sampling Techniques*, 3rd Edition. New York: John Wiley & Sons, 1977.
- Decenzo, David A, and Robbins Stephen P. *Human Resource Management*.3rd edition. USA: John Willy & Sons, Inc., 1999.
- Davis, Keith. *Organizational Behavior: Human Behavior at Work*. 9th edition. New York: McGraw-Hill Inc, 1993.
- DayalIshwar. *Designing HRD Systems*. New Delhi: Concept Publication Co., 1993.
- Dessler, Gary and BijuVarkkey. *Human Resource Management*. 12th edition. New Delhi: Pearson Prentice Hall Pvt. Ltd., 2011.
- Dessler, Gary *Human Resource Management*. 9th edition. New Delhi: Pearson Education, 2003.
- Eshun, Frank Kwaku Duah. "Rewards as a motivation tool for employee performance." (2011).

- Field, Andy. *Discovering Statistics Using IBM SPSS statistics*. Sage, 2013.
- Florence, P. Sargant. "Management and the Worker." (1941): 306-308.
- Gannon, M. J. *Organizational Behaviour*. Boston: Little Brown & Co., 1979.
- Gaur, Ajai S and Sanjaya S. Gaur, "Researchers commonly use a cut-off of 0.40 to identify high loadings", *Statistical Methods for Practice and Research*, second edition. New Delhi: Response Books, 2009.
- . *Statistical Methods for Practice and Research*. 2nd edn. New Delhi: Response Books, 2009
- George T. and John W. Boudreau. *Personnel/Human Resource Management*. 5th ed., Delhi: All India Milkovich Traveller Bookseller, 2000.
- George, Milkovich T. and John W. Boudreau. *Personnel/Human Resource Management*. 5th edition. Delhi: All India Traveller Bookseller, 2000.
- Gibson, Cyrus F. *Managing Organizational Behaviour*. Homewood: Richard D. Irwin, 1980.
- Gilbreth and et al. *Organization for the Future: The New Logic for Managing Complex Organizations*. San Francisco: Jossey- Bass, 1993.
- Griffin, Richy W. *Management*. 5th ed., USA: Houghton Mifflin Co., 1995.
- Hackman, J.R & G. R. Oldham, *Work Design*, 1st Edition. NJ: Pearson Education, Inc., Upper Saddle River, 1980.
- Herzberg, Frederick. *Work and Nature of Man*. Cleveland: World Publishing Company, 1966.
- . "Motivational Theory", Retrieved on 16.10.10 from http://www.envisionsoftware.com/articles/Herzberg_Motivational_Theory.html.
- . "Work and the Nature of Man." (1966).
- Islam K. A. *Human Resource Management Practices in Bangladesh*. Dhaka: DAM Publication, 2001.
- Islam, Md. Mainul and Abdul Awal Khan, *Fundamentals of Management*. Dhaka: Abir Publication, 2014.

- J.T. Shotwell, J.T. (ed.) Final Texts of the Labor Section. *The Origins of the International Labor Organization*, October 1994..
- Kenneth, Paul Hersey, and H. Blanchard. *Management of Organizational Behaviour: Utilizing Human Resources*. 3rd ed., New Jersey: Prentice Hall Inc. Engle wood Cliffs, 1977.
- Khalekuzzaman M. *Principles of Management*. Dhaka: The Jamuna Publishers, 2010.
- Khan, Abdul Awal, and M A Taher. *Human Resource Management and Industrial Relations*. Dhaka: Abir Publications, 2013.
- . *Fundamentals of Management*. 4th ed., Dhaka: Abir Publishers, 2014.
- Kopelman, Richard E., David J. Prottas, and David W. Falk. “Construct validation of a Theory X/Y behavior scale.” *Leadership & Organization Development Journal* (2010).
- Kothari, C. R. *Research Methodology: Methods and Techniques*. 2nd ed., New Delhi: New Age International (P) Limited, Publishers, 2010.
- Maier, R. *Psychology in Industry*. 2nd edition. Boston: Houghton-Mifflin, 1955.
- Maslow, Abraham, and R. Frager. “Motivation and Personality.” (1987).
- Maslow, Abraham. *Motivation and Personality*. New York: Harper & Row, 1954.
- Mathur, Ravindra Nath. *Quality of Working Life of Women Construction Workers*. Commonwealth Publishers, 1989.
- McBey, Kenneth J, and Belcourt Monica. *Strategic Human Resources Planning*. 2nd ed., Thomson Learning, 2011.
- McGehee, William, and Paul W. Thayer. *Training in Business and Industry*. New York: John Wiley & Sons, 1961.
- McGregor, D. *The Human Side of Enterprise*. New York: McGraw-Hill, 1960
- Newstrom, J.W. and Keith Davis. *Organizational Behavior: Human Behavior at Work*. 11th ed., New Delhi: Tata McGraw-Hill Co. Ltd., 2004.
- Peter J. Dowling, and Denice E. Weich. *International Human Resource Management*. 4th ed., Thomson Learning, 2004.

- Rahman, Md. Waliar. *Human Resource Management*. 1st ed., Dhaka: Writer, 2008.
- Rao, T.V. *HRD Audit: Evaluating the Human Resource Function for Business Environment*. New Delhi: Response Books, 1999.
- . *Reading in HRD*. New Delhi: Oxford & IBH, 1990.
- . *Readings in HRD*. New Delhi: Rao Oxford & IBM, 1991.
- . *The HRD Missionary*. New Delhi: Oxford IBH, 1990.
- Raynor, Joel O. *Motivation and achievement*. VH Winston & Sons, 1974.
- Robbins, Stephen P. and M. Coulter, *Management*. India: Prentice Hall of India, 2006.
- Robbins, Stephen P. *Organisational Behaviour in Southern Africa*. Pearson South Africa, 2009.
- Scholtz, K. *The Importance of Performance Appraisals*, 2013. [www. Laborwise.co.za/labor-bytes/performance-appraisals](http://www.Laborwise.co.za/labor-bytes/performance-appraisals).
- Shields, John, Michelle Brown, Sarah Kaine, and Andrea North-Samardzic. *Managing Employee Performance & Reward: Concepts, Practices, Strategies*. Cambridge University Press, 2015.
- Singh, R.N. *Management: Thought and Thinkers*. 2nd ed., New Delhi: Sultan Chand & Sons Publishers, 1974.
- Steel, Peirs. *Motivation: Theory and Applied*. MA: Pearson Learning Solutions, Boston: Print, 2012
- Taylor, Frederick Winslow. *The Principles of Scientific Management*. New York: Harper 1911.
- Vroom, Victor H. *Work and Motivation*. New York: John Willy & Sons, 1964.
- Wehrich, Heinz, and Harold Koontz. *Management: A Global Perspective. 10th ed., USA: McGraw-Hill Inc., 1994.*
- William, F. Whyte. *Money and Motivation*. New York: Harper and Row Publisher, 1955.

Research Articles

- Abdullah, Alkhaliel Adeb, and Hooi Lai Wan. "Relationships of Non-Monetary Incentives, Job Satisfaction and Employee Performance." *International Review of Management and Business Research* 2, no. 4 (2013): 1085.
- Absar, Mir Mohammed Nurul, Mohammad Tahlil Azim, Nimalathasan Balasundaram, and Sadia Akhter. "Impact of Human Resources Practices on Job Satisfaction: Evidence from Manufacturing Firms in Bangladesh." *Economic Sciences Series* 62, no. 2 (2010): 31-42.
- Adams, James Stacy, & S. Freedman. "Equity Theory Revisited: Toward a General Theory of Social Interaction." *Advances in Experimental Social Psychology* 9 (1976): 421-436
- . "Inequity in social exchange." In *Advances in experimental social psychology*, vol. 2, pp. 267-299. Academic Press, 1965.
- . "Inequity in Social Exchange." *Advances in Experimental Psychology*, In L. Berkowitz Ed. (New York: Academic Press, 1965): 267-299.
- . "Toward an Understanding of Inequity." *Journal of Abnormal and Social Psychology* 67 (1963): 422-436
- . "Wage Inequities, Productivity, and Work Quality." *Industrial Relations* 3 (1963): 9-10.
- Ahmad, Tahir, Faiza Farrukh, and Sana Nazir. "Capacity Building Boost Employees Performance." *Industrial and Commercial Training* 47, no. 2 (2015).
- Ahmed, Ishtiaq, and Sadia Shabbir. "The Effects of Rewards on Employee's Performance in Banks: A Study on Three Districts (Lodhran, Vehari, Khanewal)" Commercial Banks in Pakistan." *International Review of Management and Business Research* 6, no. 1 (2017): 352-361.
- Airoldi, D.M. "Employment Matters", *Incentives* 180, no. 8 (2006..
- Akafo, Vera, and Peter Agyekum Boateng. "Impact of Reward and Recognition on Job Satisfaction and Motivation." *European Journal of Business and Management* 7, no. 24 (2015): 112-124.

- Akhtar, Naeem, Shazad Aziz, Zahid Hussain, Saqib Ali, and Muhammad Salman. "Factors Affecting Employees Motivation in Banking Sector of Pakistan." *Journal of Asian Business Strateg* 4, no. 10 (2014): 125-133.
- Akinci, Serkan, Erdener Kaynak, Eda Atilgan, and Şafak Aksoy. "Where Does the Logistic Regression Analysis Stand in the Marketing Literature? A Comparison of the Market Positioning of Prominent Marketing Journals." *Marketing Literature* 539 (2005). www.emeraldinsight.com/0309-0566.htm
- Alderfer, Clayton P. "An Empirical Test of a New Theory of Human Needs." *Organizational Behavior and Human Performance* 4 no. 2 (1969): 142–175. [doi:10.1016/0030-5073\(69\)90004-X](https://doi.org/10.1016/0030-5073(69)90004-X).
- Ali, Amjad, and Bhawasti Patnaik. "Influence of Organizational Climate and Organizational Culture on Managerial Effectiveness: An Inquisitive Study." *The Carrington Rand Journal of Social Sciences* 1, no. 2 (June 2014): 1-20.
- Ali, S., Maryam Afridi, Marrium Shafi, Huda Munawar, and Sajid Mahmood Alvi. "Impact of Tangible and Intangible incentives on job satisfaction among workers." *International Journal of Management Excellence* 7, no. 3 (2016): 2292-1648.
- Ali, Syeda Ayat-e-Zainab, Maryam Afridi, Marrium Shafi, Huda Munawar, and Sajid Mahmood Alvi. "Impact of Tangible and Intangible Incentives on Job Satisfaction among Workers." *International Journal of Management Excellence* 7, no. 3 (2016): 2292-1648.
- Ali, Taskina, and Md. K. Newaz. "Factors Contributing to Job Stress of Private Bank Employees in Bangladesh." *East West Journal of Business and Social Studies* 1 (2010): 89-104.
- Al-Jabari, Mohammad. "Factors Affecting Human Resource Practices in a Sample of Diversified Palestinian Organizations." *Tourism & Management Studies* (2013): 594-603.
- Almer, Elizabeth Dreike, Margaret G. Lightbody, and Louise E. Single. "Successful Promotion or Segregation from Partnership? An Examination of the "Post-Senior Manager" Position in Public Accounting and the Implications for Women's Careers." In *Accounting Forum*, vol. 36, no. 2, pp. 122-133. No longer published by Elsevier, 2012. http://apira2010.econ.usyd.edu.au/conference_proceedings/APIRA-2010-277-LightbodyPost-senior-manager-positions-and-womens-careers-in-public-accounting.pdf.

- Al-Zawahreh, Abdelghafour, and Faisal Al-Madi. "The Utility of Equity Theory in Enhancing Organizational Effectives." *European Journal of Economics, Finance and Administrative Sciences* 46 (3) (2012): 158-170.
- Appelbaum, Steven H., Michel Roy, and Terry Gilliland. "Globalization of Performance Appraisals: Theory and Applications." *Management Decision* 49, no. 4 (2011): 570-585.
- Atkinson, J.W. "Strength of Motivation and Efficiency of Performance. In Atkinson and Raynor JO (Eds)." *Motivation and Achievement*, Washington, D.C.: Winston & Sons. (1974, h).
- Attorney, A. "Performance Appraisal Handbook." (2007).
- Azim, T. M. & M.M. Haque, "A Survey on Practices of Performance Appraisal in Bangladesh." *Journal of Business Administration*, IBA, DU, 33, no.(1&2) (2007):89-113.
- Aziri, Jacqueline. "Employee Motivation Incentives and their Impact on the Organization's Productivity." *Texila International Journal of Management*. Retrieved from: <https://pdfs.semanticscholar.org/93f9/7059d9b1302f037adf5ee2050779d2360715> (2019).
- Azzone, Giovanni, and Tommaso Palermo. "Adopting Performance Appraisal and Reward Systems", *Journal of Organizational Change Management*, 24, no. 1 (2011): 90 – 111. <http://dx.doi.org/10.1108/09534811111102300>.
- Balasubramanian, Senthil Arasu, and Remya Lathabhavan. "Women's Glass Ceiling Beliefs Predict Work Engagement and Burnout." *Journal of Management Development* 36(10) (2017). DOI: 10.1108/JMD-12-2016-0282.
- Basu, C.R. "Human Resource Development." *Indian Journal of Commerce* XI (Jan-June 1987):150-151.
- Berkowitz, Leonard, Colin Fraser, F. Peter Treasure, and Susan Cochran. "Pay, equity, job gratifications, and comparisons in pay satisfaction." *Journal of Applied Psychology* 72, no. 4 (1987): 544.
- Bhatti, Nadeem Anwar Ali Shah G. Syed, and F.M. Shaikh. "Job Satisfaction and Motivation in Banking Industry in Pakistan." *Journal of Asian Business Strategy* 2, no. 3 (2012): 54-62.

- Bhuiyan, Basir Ahmed, K.M. Mortuza Ali, M.A.A. Nurunnabi, and Tofayel Ahmed. "A Study of Relationships among Job Design, Motivation and Performance of the Employees in the Insurance Sector of Bangladesh." *Insurance Journal* 54 (July 2003): 35-57.
- Chahal, Aarti, Seema Chahal, Bhawna Chowdhury and Jyoti Chahal. "Job Satisfaction among Bank Employees: An Analysis of the Contributing Variables towards Job Satisfaction." *International Journal of Scientific & Technology Research* 2 (August 2013).
- Chatterji, Mudhumita and MH Sharieff. "Influence of Organizational Culture on Decision Making in Selected Public Sector Enterprises." *Ushus JB Management* 14, no. 1(2015):1-14.
- Cheema, D, Sobia Shujaat, and Rafia Alam. "Impact of Non-monetary Rewards on Employees' Motivation", *Journal of Management and Social Sciences.*" 9, no. 2 (2013): 1-5.
- Chen, Jie, and Derek Eldridge. "Are Standardized Performance Appraisal Practices Really Preferred? A Case Study in China." *Chinese Management Studies* 4, no. 3 (2010): 244 –257.
- Chowdhury, Iftekhar Ghani. "Human Resource Development: A competitive Perspective." *Journal of Business Administration, IBA, DU*, 29 (July & October, 2003).
- Chowdhury, Md. Abdul Mannan. "Human Resource Development and Economic Growth: A Critical Analysis with Special Reference to Bangladesh." *Insurance Journal, Bangladesh Insurance Academy* 54 (July 2003):149.
- Cochran, William G. *Planning and analysis of observational studies*. Vol. 232. John Wiley & Sons, 2009.
- Danish &Usman. "The Impact of Reward and Recognition on Job Satisfaction and Motivation: An Empirical Study from Pakistan." *International Journal of Business and Management* 15, no. 2 (February 2010).
- Das, A.C. "Causes and Effects of Stress among Working Women in Banking Sector, Bangladesh." *Mediscope, The Journal of GMC* 3 no. 1 (2016): 1-7.
- Dayal, Ishwar. "Current Perspectives and Future Issues: HRD in Indian Organizations." *Vikalpa* 14(October-December 1989): 9-15.

- Deci, Edward L., Richard Koestner, and Richard M. Ryan. "A Meta-Analytic Review of Experiments Examining The Effects of Extrinsic Rewards on Intrinsic Motivation." *Psychological Bulletin* 125, no. 6 (1999): 627.
- Diriwaechter, Patric, and Elena Shvartsman. "The Anticipation and Adaptation Effects of Intra-and Interpersonal Wage Changes on Job Satisfaction." *Journal of Economic Behavior & Organization* 146 (2018): 116-140. DOI: 10.1016/j.jebo.2017.12.010.
- Donoghue, Christopher. "Nursing Home Staff Turnover and Retention: An analysis of National Level Data." *Journal of Applied Gerontology* 29, no. 1 (2010): 89-106.
- Durbin, James, and Geoffrey S. Watson. "Testing for Serial Correlation in Least Squares Regression. III." *Biometrika* 58, no. 1 (1971): 1-19. doi:10.2307/2334313.
- Dzuranin, ANN, and Nathan Stuart. "The Effect of Tangible and Intangible Noncash Rewards on Performance and Satisfaction in a Production Setting." *Management Accounting Quarterly* 13, no. 4 (2012): 1.
- Ekra Kabura Mwangi, D.R, and Mary Omondi. "Factors Influencing Staff Retention in the Banking Industry in Kenya: A Case Study of Equity Bank Limited." *The Strategic Journal of Business & Change Management* 3(May 2016): 428-454. www.strategicjournal.com
- El-Farr, Hadi, and Rezvan Hosseingholizadeh. "Aligning Human Resource Management with Knowledge Management for Better Organizational Performance: How Human Resource Practices Support Knowledge Management Strategies?." In *Current Issues in Knowledge Management*. Intech Open, 2019.
- Ellemers, Naomi, Dick De Gilder, and S. Alexander Haslam. "Motivating Individuals and Groups at Work: A Social Identity Perspective on Leadership and Group Performance." *Academy of Management Review* 29, no. 3 (2004): 459-478.
- Enekwe, C.I., K.N. Eziedo and C.I. Agu. "Effect of Performance Appraisal on Employee Productivity in Nigerian Banking Sector." *International Journal of Research in Management Fields*, 3 (6), 2019. <https://doi.org/10.26808/rs.rmf.v3i6.02>.
- Erbasi, Ali, and Tugay Arat. "The effect of Financial and Non-Financial Incentives on Job Satisfaction: An Examination of Food Chain Premises in Turkey." *International Business Research* 5, no. 10 (2012): 136.

- Eshun, Frank Kwaku Duah. "Rewards as a Motivation tool for Employee Performance." *In Introduction to Healthcare Management* (2011).
- Faisal Ahammad, Mohammad, Sang Mook Lee, Miki Malul, and Amir Shoham. "Behavioral ambidexterity: The impact of incentive schemes on productivity, motivation, and performance of employees in commercial banks." *Human Resource Management* 54, no. S1 (2015): s45-s62.
- Fraser, Berkowitz, Treasure, and Cochren. "Pay, Equity, Job Gratification, and Comparisons in Pay Satisfaction." *Journal of Applied Psychology* 72 (1987): 544-551.
- Gardner, C.E. "Employee Evaluation: Is it Worth the Effort?." *DVM* 18, no.5: 647-81.
- Ginji et al. "Talent Management- A Strategic HRD Initiative- A Case Study of a Public Sector Bank." *Indian Journal of Training & Development* XXXXII, no. 1(January-March 2012): 58-70.
- Githinji, N., and H. Gachunga. "Influence of Organizational Climate on Employee Performance in State Corporations in Kenya: A Case of Kenya Industrial Estates Limited." *The Strategic Journal of Business & Change Management* 4, no. 2 (2017): 376-395.
- Grant, Adam M. "The Significance of Task Significance: Job Performance Effects, Relational Mechanisms, and Boundary Conditions." *Journal of Applied Psychology* 93, no. 1 (2008): 108.
- Gruman, Jamie A., and Alan M. Saks. "Performance Management and Employee Engagement." *Human Resource Management Review* 21, no. 2 (2011): 123-136.
- Gulati, Rachita. "Trends of cost efficiency in response to financial deregulation." *Benchmarking: An International Journal* (2015).
- Gulati, Rachita. "Trends of Cost Efficiency in Response to Financial Deregulation: The Case of Indian Banks." *Benchmarking: An International Journal* 22, no. 5 (2015): 808-838.
- Habib, Laila. "A Study of the Existing of Glass Ceiling in the Telecommunication Sector of Bangladesh." *Journal of Business and Management* 17, Issue 12 (2015): 34-38, DOI: 10.9790/487X-171213438.

- Hackman, J. Richard, and Greg R. Oldham. "Motivation through the Design of Work: Test of a Theory." *Organizational Behavior and Human Performance* 16, no. 2 (1976): 250-279.
- Hackman, J. Richard, and Greg R. Oldham. "Development of the Job Diagnostic Survey." *Journal of Applied Psychology* 93 (1976): 108-124, DOI: 10.1037/0021-9010.93.1.108
- Hadi El-Farr & Rezvan H, "Aligning HRM with Knowledge Management for Better Organizational Performance: How Human Resource Practices Support Knowledge Management Strategies", 2019 DOI: 10.5772/intechopen.86517
- Haynes, Kathryn. "Accounting as Gendering and Gendered: A Review of 25 Years of Critical Accounting Research on Gender." *Critical Perspectives on Accounting* 43 (2017):110-124, Elsevier. DOI: 10.1016/j.cpa.2016.06.004.
- Hershey, Paul, Kenneth H. Blanchard, and Dewey Johnson. "Management of organizational behavior." *Prentiss Hall, England Cleft, NJ* (1977): 236-244.
- Herzberg, Frederick. "Workers' Needs: The Same Around The world." *Industry Week* 21, no. 9 (1987): 29-30.
- Hitt, Michael A. Barbara W. Keats and Samuel M. DeMarie. "Navigating in the New Competitive Landscape: Building Strategic Flexibility and Competitive Advantage in the 21st Century." *The Academy of Management Executive* 12 No. 4 (2005): 22-42. <https://www.jstor.org/stable/4165492>
- Holton Iii, Elwood F., Reid A. Bates, and Sharon S. Naquin. "Large-Scale Performance-Driven Training Needs Assessment: A Case Study." *Public Personnel Management* 29, no. 2 (2000): 249-268.
- Homberg, Fabian, Dermot McCarthy, and Vurain Tabvuma. "A Meta-Analysis of the Relationship between public service motivation and job satisfaction." *Public Administration Review* 75, no. 5 (2015): 711-722.
- Hossain, Md. Akram. "Working Environment for Female Employees in Bangladesh Corporate Sector Organizations: An Exploratory Study." *South Asian Journal of Policy and Governance* 38 (1) (2016): 4975.
- Hossain, MM. "Strategy for Improving the Quality of Bank Services in Bangladesh." In Reb, Aed, *Management Development: Growth With Equity*, (1998), AMDISA: 275.

- Hossain, S. M., Mihir Kumar Roy, and Prosenjit Kumar Das. "Factors Affecting Employee's Turnover Intention in Banking Sector of Bangladesh: An Empirical Analysis." *ASA University Review* 11, no. 2 (2017).
- Huang, Jiekun, and Darren J. Kisgen. "Gender and Corporate Finance: Are Male Executives Overconfident Relative to Female Executives?." *Journal of Financial Economics* 108, no. 3 (2013): 822-839.
- Idowu, Ayomikun. "Effectiveness of Performance Appraisal System and Its Effect on Employee Motivation." *Nile Journal of Business and Economics* 3, no. 5 (2017): 15. <https://doi.org/10.20321/nilejbe.v3i5.88>
- Ireland, R. Duane and Michael A. Hitt. "Achieving and Maintaining Strategic Competitiveness in the 21st Century: The Role of Strategic Leadership." *The Academy of Management Executive* 19 No. 4 (2005): 63-77.
- Islam, Md Asadul, and Amer Hamzah Jantan. "The Glass Ceiling: Career Barriers for Female Employees in the Ready Made Garments (RMG) Industry of Bangladesh." *Academy of Strategic Management Journal* 16, no. 3 (2017).
- Islam, Mohammad Ariful and Tazrina Farah. "Job Facilities and Employee Satisfaction: Exploring the Situation of Banking Institutions in Bangladesh." *Dhaka University Journal of Business Studies* XXXV No. 1 (April 2014): 105-122.
- Islam, Mohammad Tazul Md. Masudul Haque, Rexona Yesmin, Md. Rafiqul Islam, and Md. Mazharul Islam. "Human Resource Management of Banks." *Banking Review Series* 2017, BIBM (2017): 318-19.
- Jabbar Mohammad Abdul and Md. MesbahUddin. "Employee Turnover Intention in Bangladesh." *Dhaka University Journal of Business Studies* XXXV, No. 1(April 2014): 141-150.
- Jahan, D.S. "Employee Performance Appraisal System: A Study on Square Pharmaceuticals Limited." *Dhaka University Journal of Business Studies* 49 61(2016):47-61.
- Jamali, Dima, Assem Safieddine, and Maya Daouk. "The Glass Ceiling: Some Positive Trends from the Lebanese Banking Sector." *Women in Management Review.* *Women in Management Review* 21 (8) (2006).
- Jejeebhoy, Shireen J., and Zeba A. Sathar. "Women's Autonomy in India and Pakistan: The Influence of Religion and Region." *Population and Development Review* 27, no. 4 (2001): 687-712. DOI: doi.org/10.1111/J.1728-4457.2001.00687.x

- Johns, Merida L. "Breaking the Glass Ceiling: Structural, Cultural, and Organizational Barriers Preventing Women from Achieving Senior and Executive Positions." *Perspectives in Health Information Management/AHIMA, American Health Information Management Association* 10, no. Winter (2013).
- Joseph, Jerome and Kuldeep Singh. "Organization Effectiveness Through HRD" *Indian Journal of Industrial Relations*, Oxford and IBH Publications Co. Pvt. Ltd., New Delhi, 36 No. 1 (July 2000): ix+102-108.
- Joubert, S., and C. S. Jonker. "Emotion Work and Well-being of Client Service Workers within Small and Medium-sized Enterprises." *Management Dynamics: Journal of the Southern African Institute for Management Scientists* 18, no. 2 (2009): 35-48.
- JurisIljims, Viktoija Skvarciany and ElinaGaile-Sarkane. "Impact on Organizational Climate Through Organizational Culture factors. Case Study of Latvia and Lithuania." *Trends Economics and Management* 9 (2015): 24: 9-16.
- Kaiser, Henry F. "An Index of Factorial Simplicity", *Psychometrica*, 39 (1974): 31-36.
- Kamal, Rifat Darina, and Amina Sabrin. "Gender Gap and Present State of Working Women in Corporate Arena: An Overview of Bangladesh Perspective." *Research on Humanities and Social Sciences* 4, no. 10 (2014): 82-88.
- Kaura, Vinita, and Saroj Kumar Datta. "Impact of Service Quality on Satisfaction in the Indian Banking Sector." *IUP Journal of Marketing Management* 11, no. 3 (2012).
- Khan, M.N. "HRD in Model Technological Structure." *Indian Journal of Commerce*, Jan-June 1987, Vol. XL No: 150-51: 83.
- Khan, Mukaram, Anam Tarif, and Syed Sohaib Zubair. "Non-financial incentive system and organizational commitment: An empirical investigation." *Pakistan Business Review (ISSN: 1561-8706)* 18, no. 1 (2016): 55-75.
- Khan, Mukaram, Anam Tarif, and Syed Sohaib Zubair. "Non-Financial Incentive System and Organizational Commitment: An Empirical Investigation." *Pakistan Business Review (ISSN: 1561-8706)* 18, no. 1 (2016): 55-75.
- Kopelman, R. E. D., J. Prottas and D. W. Falk. "Construct Validation of a Theory X/Y Behavior Scale," *Leadership and Organization Development Journal* 31, no. 2 (2010):120–135.
- Kumar, Alok. "Self-selection and the Forecasting Abilities of Female Equity Analysts." *Journal of Accounting Research.* *Journal of Accounting Research* 48, no. 2 (2010): 393-435.

- Kumar, Alok. "Self-selection and the forecasting abilities of female equity analysts." *Journal of Accounting Research* 48, no. 2 (2010): 393-435.
- Kumar, Dhanonjoy, Md Zakir Hossain, and Mst Shahnaz Nasrin. "Impact of Non-financial Rewards on Employee Motivation." *Asian Accounting and Auditing Advancement* 5, no. 1 (2015): 18-25.
- L. Nadler, Len. "Defining the Field - Is it HRD or OD." *Training & Development Journal* 34, no. 12 (December 1980) published by ASTD.
- Lakkoju, Srinivas. "HRD Climate in Indian Commercial Banks: A Comparative Study." *Indian Journal of Training and Development* 44, no. 2 (July-September 2014):32-43.
- Lashari, Aamir Ali, Imran Ahmed Shah, Sahira Malkawy, and Shahdma Parveen. "Measuring the Factors Affecting Job Characteristics with Personal Outcomes" (A Case Study of Khairpur Sugar Mill)." *Archives of Business Research* 7(11), (2019): 104-118.
- Lasna Kabir Syeda and SK Tawfique Haque. "Bashing the Glass Ceiling for the Women in Bangladesh Civil Service: An Overview." *24th World Congress of Political Science* (July 23-28, 2016) Istanbul, Turkey.
- Leiter, Michael P., and Christina Maslach. "Areas of Work Life: A Structured Approach to Organizational Predictors of Job Burnout." *Research in Occupational Stress and Well Being* 3, no. 1 (2003). in Perrewe, P.L. and Ganster, D.C. (Eds), *Emotional and Physiological Processes and Positive Intervention Strategies*, 2003, Vol.3, Emerald Group Publishing Limited: 91-134.
- Likert, Rensis. "A Technique for the Measurement of Attitudes." *Archive of Psychology* 22 (1932): 5-55
- Locke, Edwin A. "The Nature and Cause of Job Satisfaction." *Hand Book of Industrial and Organizational Psychology*, 1 (1976): 1297-1343.
- Ludwikowska, Kamila. "The Effectiveness of Training Needs Analysis and Its Relation to Employee Efficiency." *Zeszyty Naukowe Politechniki Poznańskiej. Organizacja i Zarządzanie* (2018). DOI: 10.21008/j.0239-9415.2018.077.11.
- Lunenburg, Fred C. "Expectancy Theory of Motivation: Motivating by Altering Expectations." *International Journal of Management, Business and Administration* 15(1) (2011): 1-6.

- Lunenburg, Fred C..“Goal-setting theory of motivation.” *International Journal of Management, Business, and Administration* 15, no. 1 (2011): 1-6.
- Maduka, Chukwuma Edwin, and Obiefuna Okafor. “Effect of motivation on employee productivity: A study of manufacturing companies in Nnewi.” *International Journal of Managerial Studies and Research* 2 (7), (2014): 137-147.
- Malhotra, Neeru, Pawan Budhwar, and Peter Prowse. “Linking Rewards to Commitment: An Empirical Investigation of four UK Call Centres.” *The International Journal of Human Resource Management* 18 (12), (2007): 2095-2128.
- Manika, M., and K. Kaliyamurthy. “A Detailed Review of Organizational Climate.” *International Journal of Development Research* 6, no. 7 (July 2016): 8625-8633.
- Mathew, A., Stults-Kolehmainen and Rajita Singha. “The Effects of Stress on Physical Activity and Exercise.” *Sports Medicine* 44 (January 2014): 81-121. doi: 10.1007/s40279-013-0090-5.
- Mathibe, Isaac. “Expectancy Theory and its Implications for Employee Motivation.” *Academic Leadership: The Online Journal* 6 (3) (Summer 2008). Available: <https://scholars.fhsu.edu/alj/vol6/iss3/8>.
- Md. ShibliShahriar, “Job Satisfaction of Employees: A Study on Real Estate Companies in Dhaka City,” *Daffodil International Journal of Business and Economics* 9 (2) (December 2015): 79-93.
- Mehedi Fakhruddin and R.H. Sumon, “Women in the Banking Sector Fall Far Behind Men”, *Observer*, 26 April 2017.
- Mishra, Anjay Kumar. “Effectiveness of Organization through Effective Human Resource Planning and Leading.” *Journal of Advanced Research in HR & Organizational Management*, 06(3&4) (2019): 1-2. <https://doi.org/10.24321/2454.3268.201902>.
- Mishra, Prashant, Upinder Dhar and Santosh Dhar. “Job Satisfaction As A Correlate of HRD Climate- An Empirical Study”,*Indian Journal of Training & Development* 43, no. 3 (July-September 2013): 27-31.
- Monika, M., and K. Kaliyamurthy. “A detailed review of organizational climate.” (2017).

- Nabi, Md. Nurun Md. Monirul Islam, Tanvir Mahady Dip, and Md. Abdullah Al Hossain. "Impact of Motivation on Employee Performances: A Case Study of Karmasangsthan Bank, Bangladesh." *Arabian Journal of Business and Management Review* 1, no. 1 (2017). DOI: 10.4172/2223-5833.1000293.
- Nakhate, Vidya. "Critical Assessment of Fredrick Herzberg's Theory of Motivation with Reference to Changing Perception of Indian Pharma Field Force in Pune Region." *The International Journal of Business & Management* 81 (1) (January 2016):182-190.
- Nazmul, Abdul Kader, Nazrul Islam, and Md Alam. "Glass Ceiling Factors, Job Satisfaction and Job Switching Decisions of Female Employees in Private Sector Enterprises of Bangladesh." *The Business Review* 5 (2016): 79-79.
- Newaz, M. K., T. Ali, and I. Akhter. "Employee Perception Regarding Turnover Decision in Context of Bangladesh Banking Sector." *BRAC University Journal* 4, no. 2(2007): 67-74.
- Ng, E.C., Z.H. Kumar, C. Ramendran, & V. Kadireson, "An Effectiveness of HRM Practices on Employee Retention in Institute of Higher Learning: A Regression Analysis", *International Journal of Business Research and Management (IJBRM)* 3, no. 2 (2012):60-79.
- Ngwa, Walters T., Bamidele S. Adeleke, Emmanuel K. Agbaeze, Nwanneka C. Ghasi, and Benedict O. Imhanrenialena. "Effect of Reward System on Employee Performance among Selected Firms in the Litoral Region of Cameron." *Academy of Strategic Management Journal* 18, no. 3 (2019): 1-16. Corpus ID: 19859340.
- Norman RF Maier, and L. Richard Hoffman, "Organization and creative problem solving," *Journal of Applied Psychology* 45, no. 4 (1961): 277.
- Omollo, Pamela Akinyi. "Effect of Motivation on Employee Performance of Commercial Banks in Kenya: A Case Study of Kenya Commercial Bank I Migori County." *International Journal of Human Resource Studies*, 5 (2) (2015): 87-103.
- Panagoitakopoulos, A. "The Impact of Employee Learning on Staff Motivation in Greek Small Firms: The Employees Perspective." *Development and Learning in Organizations an International Journal* 27 (2) (2013): 13-15.
- Pandey, Bobby Brahme and Sanjay Pandey. "An Empirical Analysis to Examine the Motivational Factors and Its Effect on Bank Employees." *Indian Journal of Social Science Research* 14 No. 2 (2017): 431-437.

- Pang, Kelvin, and Chin-Shan Lu. "Organizational Motivation, Job Satisfaction and Organizational Performance: An Empirical Study of Container Shipping Companies in Taiwan." *Maritime Business Review* (March 2018). <https://doi.org/10.1108/MABR-03-2018-0007>.
- Pareek, Udai. "HRD in India: Prospect and Retrospect." *The Indian Journal of Social Work* 52, no. 4 (1991): 457-473.
- Parijat, Pranav and Shilpi Bagga. "Victor Vroom's Expectancy Theory of Motivation- An Evaluation," *International Research Journal of Business and Management-IRJBM* VII (9) (September 2014): 1-8.
- Parshetty, Srinath. "Employee Motivation and Their Impact on Employee Performance in Banking Sector in Hyderabad Karnataka Region." *International Journal of Trend in Scientific Research and Development (IJRSRD)* 3 (2019): 390-393.
- Pathak, Hari Prasad. "Job Satisfaction of Employees in Commercial Banks." *The Journal of Nepalese Business Studies* 9 (2015): 63-73.
- Patil, B.S., and H.R. Swapna. "Human Resources Development Practices and Employee Productivity in Banking Sector." *Journal of Management Value and Ethics* 7 (April 2017). www.researchgate.net
- Padmavathy C., M.S. Balaji, and V.J. Sivakumar. "Measuring Effectiveness of Customer Relationship Management in Indian Retail Banks." *International Journal of Bank Marketing* 4 (2012).
- Peng, Chao-Ying Joanne, Kuk Lida Lee, and Gary M. Ingersoll. "An Introduction to Logistic Regression Analysis and Reporting", *The Journal of Educational Research* 96 (1), (2002). DOI: 10.1080/0020670209598756.
- Perkbox. "The 2018 UK Workplace Stress Survey", <https://www.perkbox.com/uk/resources/library/interactive-the-2018-uk-workplace-stress-survery>; Chieu Cao, Co-founder and Chief Marketing Officer (CMO) at Perkbox*The Labour Force Survey (LFS), November 2017, www.hse.gov.uk/statstc/tables 2018. In *The Most Stressed Workers in the UK Revealed* Chris Maccolgan, 2018 [www: https://recruitmentbuzz.co.uk/stressed-workers-uk-revealed/](http://www.recruitmentbuzz.co.uk/stressed-workers-uk-revealed/)
- Poll, Harris, "Stress in America." *The American Psychological Association*. The American Institute of Stress (2017).

- Priya, T. Usha, and T. Shakthi Eshwar. "Rewards, Motivation and Job satisfaction of employees in Commercial Banks- An Investigative Analysis." *International Journal of Academic Research in Business and Social Sciences* 4, no. 4 (2014): 70-78. www.Hrmars.com
- Rabb, Mohammad Jamal Uddin Muhammad Fazlur, and Md Mizanur Rahman. "Quality of Work Life and Life Balance of Tea Workers in Bangladesh." *METROPOLITAN UNIVERSITY JOURNAL*: 52.
- Ragupathi, M. and G. Prabu. "Factors Influencing Job Satisfaction and Motivation of Construction Workers in Salem District." *Asia Pacific Journal of Research* 1, Issue XLV(November 2016): 43-51.
- Rahaman, Mohammed Habibur, Tripti Sen, Johena Yasmin, Sufianur Rahman, and Md Lutfor Rahman Shimanta. "Impact of ASA Microcredit on Livelihood Status of Rural Women in Sylhet, Bangladesh." *Asian Research Journal of Arts & Social Sciences* (2019): 1-9.
- Rahimic, Zijada. "Influence of organizational climate on job satisfaction in Bosnia and Herzegovina companies." *International Business Research* 6 (3) (2013): 129.
- Rahimic, Zijada. "Influence of Organizational Climate on Job Satisfaction in Bosnia and Herzegovina Companies." *International Business Research* 6, no. 3 (2013): 129.
- Rahman Shaikh Moksadur and Sayedul Al-Amin. "Job Satisfaction among College Teachers in Comilla District, Bangladesh." *Dhaka University Journal of Business Studies* XXXV (1) (April 2014): 227-243.
- Rahman, M.M., M. Abdul, N.A. Ali, J.M. Uddin and S.M. Rahman. "Employee Retention Strategy on Quality of Work Life (QWL) Dimensions of Private Commercial Banks in Bangladesh." *Social Sciences & Humanities*, 25, no. 2 (2017): 647-662.
- Rahman, Md Hasebur, and Sheikh M. Nurullah. "A Comparative of Motivating Potential Score of Employees of Public and Private Commercial Banks: An Assessment of Demographics Influence." *Global Journal of Management and Business Research* 14 (2014).
- Rahman, Md. Hasebur. "Employees' Motivation in Public and Private Commercial Banks in Bangladesh: A Study on Need-Based Approach," *Global Disclosure of Economics and Business* 2 (2) (2013):84-91.

- Rahman, Md. Minhajur and Md. Mukitul Hoque. "An analysis of Employee Job Satisfaction: A Study on United Commercial Bank Limited." *International Journal of Ethics in Social Sciences* 2 (2) (December 2014).
- Rahman, Mohammad Azizur, and Mohammad Rafiul Azam Khan. "Investigating the Effect of Women's Position on Advancement in the Banking Sector of Bangladesh." *International Journal of Social Sciences and Management* 7, no. 4 (2020): 191-197. DOI: 10.3126/ijssm.v7i4.32483.
- Raman, M.M., M.J. Uddin, and F.R. Raab, "Quality of Work Life and Life Balance of Tea Workers", *Metropolitan University Journal* 5, no.1 (2015):55-70.
- Rasha, Mohamed, Ngui Thomas Khatua and Malai Benjami. "Factors Determining Retention in the Banking Sector: A Case Study of Agricultural Bank of Sudan", *Journal of Education & Entrepreneurship*, 2017, Vol. 4: 1-23, <https://doi.org/10.26762/jee.2017.4000001>.
- Riaz, Haseeb, Ch Akhtar, and Ramsha Aslam. "Total Rewards and Employee Performance: Investigating the Mediating Role of Employee Motivation in Telecom Sector." *Pakistan Administrative Review* 2, no. 3 (2018): 342-356.
- Roethlisberger, Fritz J., and William J. Dickson. "Management and the Worker," Cambridge (Mass.) Harvard Univ. Pr., *erstmals* (1939).
- Roy, Sanjit Kumar, C. Padmavathy, M. S. Balaji, and V. J. Sivakumar. "Measuring effectiveness of customer relationship management in Indian retail banks." *International Journal of Bank Marketing* (2012).
- Salman, Atif, Nawaz Ahmad, and Faiq Matin. "Factors Affecting on Employee Retention in Banking Sector: An Investigation from Karachi", *European Journal of Business and Management*, 2014, Vol. 6 (37): 2222-1905.
- Samuels, Peter. "Advice on Exploratory Analysis Factor Analysis.", *Working Paper* (2017), <https://www.researchgate.net/publication/304490328>, DOI: 10.13140/RG.2.1.5013.9766.
- Sanad A. Alajmi, "Organizational Climate and its Relationship to Job Satisfaction in Kuwaiti Industrial Companies", *Asian Journal of Management Science and Economics*, 2016, Vol. 3(2):38-47.

- Sarpong, Lorreta. "Effects of Motivation on the Performance of Employees of Ecobank Ghana Limited. Knust Branch and Stadium Branch." *Journal of Business Theory and Practice* 4 (1) (2016):111-124.
- Shabnaz, S., S. Tasthekur, and S. Sumon. "In Organizational Factors Affecting Employees Retention: A Study on Private Commercial Banks of Bangladesh." *International Journal of Business and Management Study* 4 (2017):19-24.
- Shafiq, Malik Muhammad, and Muhammad Akram Naseem. "Association Between Reward and Employee Motivation: A Case Study Banking Sector of Pakistan." Available at SSRN 1857663 (June 2011). <https://doi.org/10.2139/ssrn.1857663>.
- Sharif, T.R. "Human Resource Development (HRD): In the Theory and Practice." *Journal of Business Administration*, IBA, DU, 25 (July & October, 1999).
- Sharma, Sapna Bobby Brahme Pandey and Sanjay Pandey. "An Empirical Analysis to Examine the Motivational Factors and Its Effect on Bank Employees." *Indian Journal of Social Science Research* 14 No. (2017): 431-437.
- Shujaat, Sobia, and Rafia Alam. "IMPACT OF NON-MONETARY REWARDS ON EMPLOYEES' MOTIVATION: A STUDY OF COMMERCIAL BANKS IN KARACHI." *IBT Journal of Business Studies (JBS)* 9, no. 2 (2013).
- Simone, Stefania De. "Expectancy Value Theory: Motivating Healthcare Worker." *American International Journal of Contemporary Research* 5 (2) (April 2015): 19-20.
- Singh, Rajendra. "Pleasure at the Workplace." *HRM Review* (September 2006): 54-57.
- Singh, S.K. and Vivek Tiwari. "Relationship between Motivation and Job Satisfaction of the White Collar Employees: A Case Study." *Management Insight* VII (2) (December 2011): 31-39.
- Sinha, Deepti, and Somesh Kumar Shukla. "A study of Employee Retention in the Pharmaceuticals sector in Dehradun City." *International Journal of Education and Psychological Research* 2, no. 1 (2013): 30-39.
- Sogra, Jahan Khair. "The Impact of Gender Differences on the Conflict Management Styles of Managers in Bangladesh: An Analysis." *Newcastle upon Tyne, UK: Cambridge Scholars Publishing* (2014).

- Sonia, Rezina, and Farhana Mahmud. "Gender Disparity in Bangladesh and Its Impact on Women in Workplace." *Scholar Journal of Business and Social Science* 2 (2) (2016): 27-34.
- Srikrishna, G. "A Study on Importance of Job Satisfaction among Employees." *Human resource management: New horizons* (2017): 22.
- Steers, Richard M., Richard T. Mowday, and Debra L. Shapiro. "The Future of Work Motivation Theory." *Academy of Management Review* 29, no. 3 (2004): 379-387.
- Sufian, Fadzlan, Fakarudin Kamarudin, and Annuar Md Nassir. "Globalization and Bank Efficiency Nexus: Empirical Evidence from the Malaysian Banking Sector." *Benchmarking: An International Journal* 24, no. 5(2017).
- Suttle, J. Lloyd. "Improving Life at Work: Problems and Prospects." *Improving Life at Work: Behavioral Science Approaches to Organizational Change*. Goodyear Publishing Company, Santa Mónica (1977).
- Svartdal, Frode, Katrin B. Klingsieck, Piers Steel, and Thor Gamst-Klaussen. "Measuring implemental delay in procrastination: Separating onset and sustained goal striving." *Personality and Individual Differences* 156 (2020): 109762.
- Tănăsescu, Carmen-Elena, and Ramona-Diana Leon. "Human Resources Practices in the Romanian Banking System: Rewards, Job Satisfaction, and Job Performance." *Management Dynamics in the Knowledge Economy* 7, no. 4 (2019): 469-483. DOI:10.25019/MDKE/7.4.02.
- Trotman, Ken T., Tim D. Bauer, and Kerry A. Humphreys. "Group Judgment and Decision Making in Auditing: Past and Future Research." *Accounting, Organizations and Society* 47 (2015): 56-72.
- Uddin, Asif and Mohammad Abuzar Wajidi. "Impact of Motivation on Performance of Employees in Private Banking Sector of Pakistan." *Global Journal of Engineering Science and Research Management* 1 (4) (August 2014): 41-48.
- Ullah, Md. Maminand SabnamJahan. "Identification of Critical Factors Regarding the Job Satisfaction among the Employees in Bangladesh: A Study on Bank Industry." *Dhaka University Journal of Business Studies* XXXIV No.3 (December 2013): 121-138.
- Walster, Elaine, Ellen Berscheid, and G. William Walster . "New Directions in Equity Research," *Journal of Personality and Social Psychology* 25, no 2 (1973): 151-176.

- Waqas, Zafarullah, and Sharjeel Saleem. "The Effect of Monetary and Non-Monetary Rewards on Employee Engagement and Firm Performance." *European Journal of Business and Management* 31 (2014): 73-82.
- Weerasinghe, I. M. S., C. J. Senavirathna, and H. H. Dedunu. "Factors Affecting to Job Satisfaction of Banking Employees in Sri Lanka Special Reference Public and Private Banks in Anuradhapura District." *Business and Management Horizons ISSN* (2017): 2326-0297.
- Weidenfeller, Nancy K. "Breaking through the Glass Wall: The Experience of Being a Woman Enterprise Leader." *Human Resource Development International* 15, no. 3 (2012): 365-374.
- William, F. WHYTE. "Money and Motivation." (1955).
- Woolley, Anita Williams, Christopher F. Chabris, Alex Pentland, Nada Hashmi, and Thomas W. Malone. "Evidence for a Collective Intelligence Factor in the Performance of Human Groups." *Science* 330, no. 6004 (2010): 686-688.
- Yang, Fang. "Work, Motivation and Personal Characteristics: An In-Depth Study of Six Organizations in Ningbo." *Chinese Management Studies* 5 (3) (2011): 272-297.
- Yu, Bonnie Bei, and Carolyn P. Egri. "Human Resource Management Practices and Affective Organizational Commitment: A Comparison of Chinese Employees in a State-owned Enterprise and a Joint Venture." *Asia Pacific Journal of Human Resource* 43, no. 3 (2005): 332-360.
- Zakaria, Zaherawati, Nazni Noordin, M. Z. H. Sawal, Z. Zakaria, M. F. M. Noor, and P. Maras. "Reward Practice in Private Sector: Employees Perception." *Interdisciplinary Journal of Contemporary Research in Business* 2, no. 12 (2011): 112-120.

Report

- Bangladesh Bank Report, *Equal Gender Status*, BB Report June-January 2019, 27 September 2019
- Bangladesh Bank (BB) Official, "Many new banks are not recruiting women employees following Bangladesh Bank's order. That's why, the ratio of women bankers is not increasing", *The Asian Age*, 26 April 2017.
- BB Official, *The Asian Age*, 26 April 2017.

- Chalmers, W. Ellison. "INTERNATIONAL LABOR ORGANIZATION." *Monthly Labor Review* 43, no. 2 (1936): 316-327.
- Financial Express (FE) Report, "Workforce Reduction during Covid-19: Information for Employers, *The Financial Express Report*, March 30, 2020.
- FE Report. "High Occupational Stress Grips Most Bank Employees." *The Financial Express Report*, December 6, 2019.
- FE Report. "Workforce Reduction during Covid-19: Information for Employers." *The Financial Express Report* (March 30, 2020).
- Gender Policy 3rd Edition, RDRS *Bangladesh*, September 2014: 8-11.
- Global Gender Gap, World Economic Forums (WEFs), 2020.
- Hegewisch, Ariane, Claudia Williams, and Vanessa Harbin. *The Gender Wage Gap by Occupation*. Institute for Women's Policy Research, 2012.
- ILO Conventions, *The Reduction of Hours of Work (Public Works) Convention*, 1936 (No. 51), and the *Reduction of Hours of Work (Textiles) Convention*, 1937 (No. 61)
- ILO. "Top Five Countries with Highest and Lowest of Women in Managerial Positions" www.weforum.org, 2015.
- ILO. *World Employment and Social Outlook 2015: The Changing Nature of Jobs*. International Labour Office, 2015.
- IWPR. "The Gender Wage Gap by Occupation", *Institute for Women's Policy Research*, 2019
- Khuda, Barkat-e. "Economic Growth in Bangladesh and the Role of Banking Sector." *Financial Express*, (January 11, 2019).
- Mahfuj Ahmed, "Jobs in Banking Sector in 2017: BIBM Study on HRM of Banks", Workshop, *New Age*, Dhaka, 25 May 2018.
- Mehedi, F, and R.H. Sumon. "Women in the Banking Sector Fall Far Behind Men." *Observer*, 26 April 2017.
- Mehedi, F, and R.H. Sumon. "Women in the Banking Sector Fall Far Behind Men." *Observer*, 26 April 2017. www.dailiasianage.com/news/58319/women-in-banking-sector-fall-far-behind-men.

The Bangladesh Report: “Report of Survey Findings and Qualitative Study Results from a Factory in Chittagong,” *Levi Straus & Co., Workers’ Well-being Study* (December, 2013): 1-37. <http://levistrauss.com/wp-content/uploads/2014/01/Workers-Well-Being-Study-Bangladesh-.pdf>. (accessed on 11.08.2017).

The Constitution, “There Shall be Equality of Opportunity for All Citizens in Respect of Employment or Office in the Service of the Republic”, *The Constitution of the People’s Republic of Bangladesh*, Act No. of 1972: Article 29 (1).

Uddin, Mahmud Zia. “Stress in Banking Job: Causes, Effects and Management.” *The Daily Observer* (15 July 2020).

Uddin, Mahmud Zia. “Stress in Banking Job: Causes, Effects and Management.” *The Daily Observer* (15 July 2020).

UN Women Gender Equality Glossary; <https://trainingcentre.unwomen.org/mod/glossary/view.php?=-36>.

Wahhab, M. Abdul. “Civil Service Recruitment Policy in Bangladesh; A Critical Analysis.” In *Paper submitted for NAPSIPAG International Conference, held on*, pp. 11-13. 2009.

WB Report, *Bangladesh-Domestic Credit Provided by Banking Sector (% of GDP)*, Trading Economics, 2018, 2016.

Women and Men in Bangladesh: Facts and Figures 2018; *BBS*, 2019, SIDA: 59

[www.https://dailyasianage.com/news/58319/women-in-banking-sector-fall-far-behind-men](https://dailyasianage.com/news/58319/women-in-banking-sector-fall-far-behind-men).

Workshop or Conference

ILO Conventions, *The Reduction of Hours of Work (Public Works) Convention*, 1936 (No. 51), and the *Reduction of Hours of Work (Textiles) Convention*, 1937 (No. 61)

Islam, T. “*Occupational Stress and Job Performance Employees of Banks: Bangladesh Perspectives*.” Key Note, BIBM, Seminar (December 4, 2019) Dhaka.

Kakkos, Nikolas and Panagiotis Trivellas. “Investigating the Link Between Motivation, Work Stress and Job Performance: Evidence from the Banking Industry.” In *8th International Conference on Enterprise Systems, Accounting and Logistics* Thassos, Greece, 10-12 July 2011

- M.M. Haque, and M.T. Azim, "Affective commitment and its antecedents: An empirical study in the context of Bangladesh", Paper presented at the 7th International Conference on Ethics and Quality of Work-life for Sustainable Development, 2008, Bangkok, Thailand.
- M.Z. Islam & S. Siengthai, "Quality of Work Life and Organizational Performance: Empirical Evidence from Dhak Export Processing Zone", Proceedings of ILO Conference on Regulating for Decent Work: Geneva: International Labor Office, 2009.
- Shabnaz, S., S. Tasthekur and S. Sumon. "Relationship of Individual Factors and HRM Practices on Employee Retention in Private Banking Sector of Bangladesh." *Eighth International Conference on Advances in Economics, Management and Social Study-EMS*. <https://doi.org/10.15224/978-1-63248-145-7-17>.

Thesis/ Dissertation

- Adu-Gyamfi, Franklin. "Prediction of Loan Default Using Logistic Regression: A Case Study of Ahafo Ano Premier Rural Bank." PhD diss. Kwame Nkrumah University of Science and Technology, Kumasi., 2017.
- Allahem, Maymonah Saleh. "The Impact of Monetary and Non-Monetary Rewards on Job Satisfaction: A Case Study of Saudi Bank in Qassim." Master's Thesis (2019), www.eimj.org, Corpus ID: 210697694
- Begum, Zinnat Ara. "Impact of Motivation on the Performance of Women Workers in Garment Industry in Bangladesh." *PhD Dissertation*, IBS, University of Rajshahi, June 2009.
- C. Eshum, C & FK Duah, "Rewards as a Motivation Tool for Employee Performance." MBA Thesis (2014);
- Chowdhury, Nohd. Mozammel Hossain. "Effect of Human Resource Management on the Performance of Private Sector Commercial Banks in Bangladesh: A Study on National Bank Limited." *PhD Dissertation*, IBS, University of Rajshahi, 2007.
- Khurram, Nazir. "Employee Motivation, Job satisfaction & Productivity of Employees at Boots 2012 (WestField Stratford City)" Master *Thesis in Business Administration*, Cardif Metropolitan University, May 2013.
- Mogire, Makambi Reuben. "Impact of Motivation on Employee Performance in Kenya, A Case of Prisons Service in Trans-Nzoia County."

- Patwari, Hossain, Shahadat, Mohammad, “Impact of Human Resource Management on the Performance of United Commercial Bank Limited: A Case Study”. *PhD Dissertation*, IBS, University of Rajshahi, June 2016.
- Riordan James Edward. “A Study of the Satisfaction and Motivation of High School Coaches.” *PhD Dissertation*, School of Education, Loyole University of Chicago, January 1989.
- Sivakumar, P. Perumal. “The Relationship of Rewards to Employee’s Performance in the e-banking Environment among Local Banks in Kuala Lumpur.” PhD diss., Universiti Utara Malaysia, 2017.
- Wahiduzzman, Md.. “Job Satisfaction and Professional Commitment: A Study on Bangladesh Civil Service Education Cadre”. *PhD Dissertation*. IBS, University of Rajshahi, 2016.

Appendices

Annexure I: Levene's Test for Equality of Variances (Output Table 1 to Table 5)

Output Table 1: Logistic supports (Male and Female)										
		Levene's Test for Equality of Variances		t-test for Equality of Means						
		F	Sig.	t	df	Sig. (2-tailed)	Mean Difference (MD)	SE Diff.	95% Confidence Interval of the Difference	
									Lower	Upper
Job related logistic support equally distributed	Equal variances assumed	.005	.944	.408	398	.683	.0194	.047	-.074	.113
	Equal variances not assumed			.432	97.8	.667	.019	.044	-.070	.109

Output Table 2 : Advancement (Male and Female)										
		Levene's Test for Equality of Variances		t-test for Equality of Means						
		F	Sig.	t	df	Sig. (2-tailed)	Mean Difference (MD)	SE Diff.	95% Confidence Interval of the Difference	
									Lower	Upper
Barrier to women advancement in the banking job	Equal variances assumed	1.513	.219	-.824	398	.411	-.068	.082	-.230	.094
	Equal variances not assumed			-.847	95.1	.399	-.067	.080	-.227	.092

Output Table 3: Recruitment and selection (R & S) (Male and Female)										
		Levene's Test for Equality of Variances		t-test for Equality of Means						
		F	Sig.	t	df	Sig. (2-tailed)	Mean Difference (MD)	SE Diff.	95% Confidence Interval of the Difference	
									Lower	Upper
No discrimination in the R & S	Equal variances assumed	2.836	.093	.199	398	.842	.013	.067	-.118	.145
	Equal variances not assumed			.225	105.4	.823	.013	.060	-.104	.131

Output Table 4: Delegation of authority (DoA) (Male and Female)										
		Levene's Test for Equality of Variances		t-test for Equality of Means						
		F	Sig.	t	df	Sig. (2-tailed)	Mean Difference (MD)	SE Diff.	95% Confidence Interval of the Difference	
									Lower	Upper
No discrimination in the DoA	Equal variances assumed	5.23	.023	-.969	398	.333	-.080	.082	-.241	.082
	Equal variances not assumed			-1.102	106.7	.273	-.080	.072	-.222	.064

Output Table 5: Vital post (Male and Female)

		Levene's Test for Equality of Variances		t-test for Equality of Means						
		F	Sig.	t	df	Sig. (2-tailed)	Mean Difference (MD)	SE Diff.	95% Confidence Interval of the Difference	
									Lower	Upper
Problem to assign women employee in a vital post	Equal variances assumed	2.607	.107	-1.98	398	.048	-.184	.093	-.360	-.001
	Equal variances not assumed			-2.06	96.1	.042	-.184	.089	-.361	-.007

Annexure II: Levene's Test for Equality of Variances (Output Table Section 1 to 5)

Independent Samples Test: Public and Private Bank

		Levene's Test for Equality of Variances		t-test for Equality of Means						
		F	Sig.	t	df	Sig. (2-tailed)	MD	SE Diff.	95% Confidence Interval of the Difference	
									Lower	Upper
1. Logistic support equally distributed	Equal variances assumed	8.209	.004	1.99	398	.047	.088	.044	.001	.174
	Equal variances not assumed			1.9	112.9	.064	.088	.047	-.005	.180
2. Barrier to women advancement in the bank	Equal variances assumed	27.76	.000	4.13	398	.000	.309	.077	.162	.457
	Equal variances not assumed			3.46	101.7	.001	.309	.089	.132	.487
3. No discrimination in the R & S	Equal variances assumed	.698	.404	7.47	398	.000	.434	.058	.320	.549
	Equal variances not assumed			7.52	122.6	.000	.434	.058	.320	.549
4. No discrimination in the DoA	Equal variances assumed	18.12	.000	5.7	398	.000	.416	.073	.272	.560
	Equal variances not assumed			4.75	101.8	.000	.415	.088	.242	.589
5. Problem to assign women employee in a vital post	Equal variances assumed	.065	.800	8.7	398	.000	.688	.079	.532	.843
	Equal variances not assumed			7.9	110.2	.000	.688	.087	.516	.859

Annexure III: Measurement for SEM on PA

CFA: Developing Structural Equation Modeling (SEM) for Later Construction

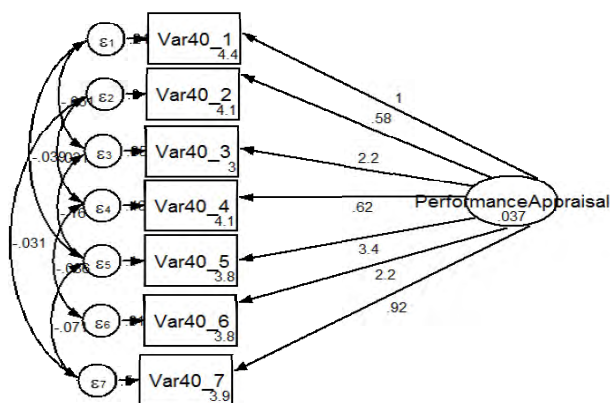

Figure 8.8 (a) shows the coefficient paths and estimation as well as mean values (from variable 40.1 to 40.7) of each variable. Here, PA is regarded as a latent factor ($\beta=0.037$) of the SEM structure.

Figure 8.8 (a) : SEM: Coefficient Path Analysis: PA Practices

CFA/SEM: PA Practices

Particulars (Measurement)	Coef.	S.E	z	P>z	95% Conf. Interval	
Performance Appraisal (Latent variable)						
Var40_1(PA_MBO)	<-					
	1	(constrained)				
_cons	4.37	0.03	167.35	0.000	4.316	4.419
Var40_2 (Fair_rewarding)	<-					
	0.58	0.24	2.4	0.016	0.108	1.059
_cons	4.13	0.03	148.42	0.000	4.078	4.187
Var40_3 (<i>Timely_promotion</i>)	<-					
	2.24	0.59	3.81	0.000	1.087	3.389
_cons	2.96	0.05	64.56	0.000	2.865	3.045
Var40_4 (Promo_seniority)	<-					
	0.62	0.28	2.21	0.027	0.070	1.163
_cons	4.06	0.04	117.42	0.000	3.995	4.130
Var40_5 (<i>Promo_performnce</i>)	<-					
	3.35	0.72	4.65	0.000	1.941	4.765
_cons	3.81	0.04	106	0.000	3.735	3.875
Var40_6 (<i>Eva_productivity</i>)	<-					
	2.23	0.76	2.92	0.004	0.732	3.723
_cons	3.84	0.04	108.97	0.000	3.768	3.907
Var40_7 (Punish-low output)	<-					
	0.92	0.33	2.79	0.005	0.274	1.566
_cons	3.88	0.04	106.61	0.000	3.811	3.954
Var (Performance Appraisal)	0.04	0.02			0.0141	0.096
var(e.Var40_1)	0.24	0.02			0.195	0.284
var(e.Var40_2)	0.3	0.02			0.258	0.343
var(e.Var40_3)	0.65	0.08			0.518	0.826
var(e.Var40_4)	0.47	0.03			0.404	0.535
var(e.Var40_5)	0.10	0.11			0.012	0.897
var(e.Var40_6)	0.31	0.05			0.225	0.438
var(e.Var40_7)	0.50	0.04			0.431	0.579
cov(e.Var40_3,e.Var40_1)	-0.07	0.03	-1.84	0.065	-0.125	0.004
cov(e.Var40_5,e.Var40_1)	-0.04	0.04	-0.99	0.324	-0.117	0.039
cov(e.Var40_4,e.Var40_2)	0.03	0.02	1.59	0.112	-0.007	0.069
cov(e.Var40_7,e.Var40_2)	-0.03	0.02	-1.49	0.136	-0.073	0.010
cov(e.Var40_5,e.Var40_3)	-0.16	0.08	-2.06	0.040	-0.320	-0.008
cov(e.Var40_6,e.Var40_4)	-0.04	0.02	-1.59	0.113	-0.081	0.009
cov(e.Var40_7,e.Var40_5)	-0.07	0.04	-1.81	0.071	-0.148	0.006
Log likelihood = -2773.2322; LR test: independent vs. saturated: chi2(21) = 280.15; Prob>chi2 = 0.0000						

Annexure IV: Measurement for SEM on Management Practices

Structural Equation Modeling for Management Practices

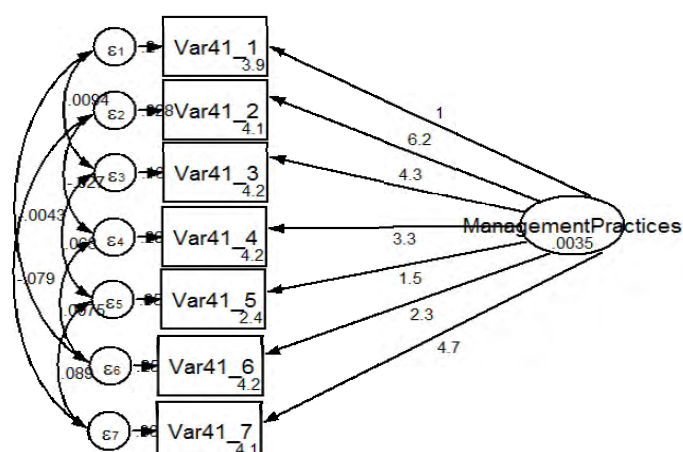

Figure 8.10 (a) depicts the SEM of the seven factors related to HRM which is regarded as the latent factor of the construction (from variable 40.1 to 40.7) of each variable. Here, it is being showing the coefficient values of the latent factor ($\beta=0.0035$).

Figure 8.10 (a): SEM/CFA: HRM Practices in banks

SEM: Management practices in the banks

Particulars (Measurement)	Coef.	Std. Err.	z	p>z	95% Conf. Interval	
Management practices (Latent factor)						
Var41_1 (SHRM)	<-					
	1	(constrained)				
_cons	3.883	0.023	172.06	0.000	3.838	3.927
Var41_2 (Fair_R & S)	<-					
	6.155	2.632	2.34	0.019	0.996	11.314
_cons	4.0925	0.012	205.05	0.000	4.053	4.132
Var41_3 (Job_description)	<-					
	4.322	1.683	2.57	0.010	1.024	7.621
_cons	4.15	0.022	189.09	0.000	4.107	4.193
Var41_4 (Eva_aca_qua)	<-					
	3.284	1.543	2.13	0.033	0.260	6.309
_cons	4.17	0.028	147.25	0.000	4.114	4.226
Var41_5 (Association)	<-					
	1.486	0.940	1.58	0.114	-0.356	3.328
_cons	2.375	0.040	58.69	0.000	2.296	2.454
Var41_6 (Equality)	<-					
	2.299	1.058	2.17	0.030	0.225	4.372
_cons	4.238	0.026	162.78	0.000	4.186	4.289
Var41_7 (Retention)	<-					
	4.750	2.279	2.08	0.037	0.283	9.216
_cons	4.145	0.032	129.58	0.000	4.082	4.208
Var (Mgt_Practices;LF)	0.003	0.003			0.001	0.017
var(e.Var41_1)	0.200	0.014			0.174	0.230
var(e.Var41_2)	0.028	0.028			0.004	0.197
var(e.Var41_3)	0.128	0.016			0.100	0.162
var(e.Var41_4)	0.283	0.024			0.240	0.335
var(e.Var41_5)	0.647	0.046			0.562	0.745
var(e.Var41_6)	0.253	0.019			0.219	0.292
var(e.Var41_7)	0.331	0.037			0.266	0.412
cov(e.Var41_3,e.Var41_1)	0.009	0.009	1.1	0.271	-0.007	0.026
cov(e.Var41_6,e.Var41_1)	-0.004	0.011	-0.38	0.703	-0.026	0.018
cov(e.Var41_4,e.Var41_2)	-0.027	0.019	-1.44	0.149	-0.064	0.010

cov(e.Var41_7,e.Var41_2)	-0.079	0.026	-3.04	0.002	-0.130	-0.028
cov(e.Var41_5,e.Var41_3)	0.063	0.017	3.8	0.000	0.031	0.096
cov(e.Var41_6,e.Var41_4)	0.008	0.016	0.47	0.641	-0.024	0.039
cov(e.Var41_7,e.Var41_5)	0.089	0.028	3.22	0.001	0.035	0.144
Log likelihood = -2077.924, LR test: independent vs. saturated: $\chi^2(21) = 341.16$ Prob> $\chi(21) = 0.000$						

Annexure V: Extracted Latent Factors from Measurement Table of SEM

Latent Factor	Effective Factor	Explored Effective Factors
Demographic	Age ($\beta=0.663$)	Work experience is related
	Present Designation ($\beta=0.571$)	Present pay is related
	First Joining Status ($\beta=0.551$)	Initial pay is closely related
	Bank Types ($\beta=0.1.67$)	Significantly effective
	Gender ($\beta=17.113$)	Highly effective
	Banking Diploma ($\beta=-2.18$)	Significantly less effective
Glass Ceiling ($\beta=0.750$)	Designation ($\beta=1.191$)	Significantly effective
	Nature of Bank ($\beta=-5.36$)	Significantly effective
Satisfaction ($\beta=0.08$)	Promotion & Transfer ($\beta=2.23$)	Effective and related
JCM ($\beta=0.021$)	Autonomy ($\beta=3.74$)	Most effective
	Designation ($\beta=4.74$)	Most effective
Hygiene ($\beta=0.124$)	Participation ($\beta=1.68$)	Highly effective
Motivational ($\beta=0.10$)	Promotion and Growth ($\beta=2.43$)	Strongly effective
Financial Benefits ($\beta=0.113$)	Profit Sharing ($\beta=1.579$)	Highly effective
Other Monetary Benefits ($\beta=0.106$)	Stopped Increment ($\beta=1.162$)	Most effective
Fringe Benefits	Job Security ($\beta=3.81$)	Strongly effective
Training ($\beta=0.01$)	Job Rotation ($\beta=3.8$)	Direct impact
Retention ($\beta=0.16$)	Increase Retention ($\beta=0.8$)	
Work environment ($\beta=0.16$)	Adequate Ventilation ($\beta=1.1$)	Effective
HRD Environment ($\beta=0.014$)	Succession Plan ($\beta=3.272$)	Highly effective
HRD Mechanisms	Risk and Fair Rewarding ($\beta=3.33$), Role Analysis ($\beta=1.47$)	Most effective
HRD Climate ($\beta=0.074$)	Collaboration ($\beta=1.03$)	Effective
PA ($\beta=0.037$)	Productivity Evaluation ($\beta=2.23$)	Highly effective
Management Practices ($\beta=0.003$)	Fair Recruitment and Selection ($\beta=6.16$)	Highly significant and effective
Employee Outcomes ($\beta=0.03$)	Committed Performance ($\beta=2.35$)	Highly effective
Organizational Outcomes ($\beta=0.15$)	Less Turnover Cost ($\beta=1.16$)	Effective

Annexure VI: Questionnaire

**Institute of Bangladesh Studies (IBS)
University of Rajshahi, Bangladesh**

Questionnaire for data collection

(Data will be used only for research purpose and ensured not to be disclosed or used for any other purposes)
Questionnaire for PhD research program on “**Employee Motivation and Human Resource Development in the Banking Sector of Bangladesh: Theories and Practices**”

PART-A: Primary Information

1. Name:
2. Sex: 1. Male 2. Female
3. Age:
4. Marital status: 1. Married 2. Unmarried
5. Religion: 1. Islam 2. Hindu 3. Others
6. Designation/ Post:
7. Type of the Bank: 1. Public 2. Private
8. Name & Location of Bank:
9. Edu. Qualification:

1. Bachelor	2. Master	3. Sub:	4. B. Diploma	5. Others
-------------	-----------	---------	---------------	-----------

PART-B: Motivation

10. How many years are you involved with this Bank?

Year	Months
------	--------
11. What is the present gross amount of your monthly salary? ---
12. What was the initial salary in this Bank?

1. Basic:	2. Gross:
-----------	-----------
13. What are the allowances included in your present gross salary?

1. Basic salary	2. House rent	3. TA	4. Lunch	5. Medical	6. Education	7. Others
-----------------	---------------	-------	----------	------------	--------------	-----------
14. Is there any increment on salary?

1. Yes	2. No
--------	-------
15. If yes, when?

1. Randomly	2. Yearly	3. On performance	4. Others
-------------	-----------	-------------------	-----------
16. What is the percentage of increment?
17. Do you think that the present salary structure of this bank is sufficient?

1. Yes	2. No	3. Unknown
--------	-------	------------
18. How many festival bonuses you do have generally in a year? ---
19. How many incentives did you get in the last year? ---
20. Normal working hours in a day?

1. <8hrs	2. >8hrs	3. 9hrs	4. 10hrs or more
----------	----------	---------	------------------
21. Do you feel stress in doing your job?

1. Yes	2. No	3. Somewhat stressed
--------	-------	----------------------
22. Is there any impact of Banking Diploma for promotion?

1. Yes	2. No
--------	-------
23. How about you're working procedure in transactions?

1. Fully manual	2. Manual	3. Partially manual	4. Online	5. Fully online
-----------------	-----------	---------------------	-----------	-----------------
24. What about your satisfaction level with the present salary?

1. Strongly Dissatisfied	2. Dissatisfied	3. Moderately satisfied	4. Satisfied	5. Strongly satisfied
--------------------------	-----------------	-------------------------	--------------	-----------------------

25. What is your opinion in the recruitment and selection?

1.Strongly Dissatisfied	2. Dissatisfied	3.Moderately satisfied	4. Satisfied	5.Strongly satisfied
-------------------------	-----------------	------------------------	--------------	----------------------

26. How much do you satisfy regarding the financial benefits?

1.Strongly Dissatisfied	2. Dissatisfied	3.Moderately satisfied	4. Satisfied	5.Strongly satisfied
-------------------------	-----------------	------------------------	--------------	----------------------

27. How much do you satisfy in the promotion and transfer policy?

1.Strongly Dissatisfied	2. Dissatisfied	3.Moderately satisfied	4. Satisfied	5.Strongly satisfied
-------------------------	-----------------	------------------------	--------------	----------------------

1. What about the level of satisfaction regarding leave policy in your bank?

1.Strongly Dissatisfied	2. Dissatisfied	3.Moderately satisfied	4. Satisfied	5.Strongly satisfied
-------------------------	-----------------	------------------------	--------------	----------------------

29. Does the bank offer career and development paths for which you are motivated?

1.Strongly Dissatisfied	2. Dissatisfied	3.Moderately satisfied	4. Satisfied	5.Strongly satisfied
-------------------------	-----------------	------------------------	--------------	----------------------

30. Please tick (√) the following (any one of the boxes on right side for each particular).

1. Never 2. Sometimes (ST) 3. Often (O) 4. Very Often (VO) 5. Always (AL)

SL	Particulars	NV	ST	O	VO	AL
30.1	Salary meets your basic needs (food, residence, clothing)	1	2	3	4	5
30.2	Job security	1	2	3	4	5
30.3	There is a good relationship among employees/ colleagues	1	2	3	4	5
30.4	Manager/Party recognizes your good performance	1	2	3	4	5
30.5	Your opinion is considered for decision making	1	2	3	4	5
30.6	Your job is interesting, prestigious, status, power and egoistic	1	2	3	4	5
30.7	Promotion for higher level is available in your bank	1	2	3	4	5
30.8	Reward is equitable	1	2	3	4	5
30.9	Your job gives you a chance of advancement taking challenging performance	1	2	3	4	5

Job Characteristics Model (JCM) Variables

31. Please tick (√) the following (any one of the boxes on right side for each particular).

1. Strongly Disagree (SD) 2. Disagree (D) 3. Neutral (N) 4. Agree (A) 5. Strongly Agree (SA)

SL	Particulars	SD	D	N	A	SA
31.1	Skill variety for same position is shown in the bank	1	2	3	4	5
31.2	Task identity due to job performance is found in the bank	1	2	3	4	5
31.3	Task significances due to do the job perfectly	1	2	3	4	5
31.4	Autonomy of the job responsibility is available	1	2	3	4	5
31.5	Job feedback from immediate authority is done	1	2	3	4	5

PART-C: Financial Benefits

32. Please tick (√) the following (any one of the boxes on right side for each particular).

1. Not at all (NA) 2. Some extent (ST) 3. Moderately extent (ME) 4. Extent (E) 5. Highly extent (HE)

SL	Particulars	NA	SE	ME	E	HE
32.1	Handsome salary influences motivation	1	2	3	4	5
32.2	Profit sharing can motivate the employees	1	2	3	4	5
32.3	Bonus has positive impact on motivation	1	2	3	4	5
32.4	Loan facilities give higher out	1	2	3	4	5
32.5	Insurance facilities create employee satisfaction	1	2	3	4	5
32.6	Transportation facilities increase satisfaction	1	2	3	4	5
Negative Financial Benefits						
32.7	Salary deduction decreases satisfaction	1	2	3	4	5
32.8	Stopped/ Postponed increment creates dissatisfaction	1	2	3	4	5
32.9	Stopped profit sharing increases dissatisfaction	1	2	3	4	5

PART-D: Fringe Benefits (Job Security and Leave Benefits)

33. Please tick (√) the following (any one of the boxes on right side for each particular).

1. Never 2. Sometimes (ST) 3. Often (O) 4. Very Often (VO) 5. Always (AL)

SL	Job Security	NV	ST	O	VO	AL
33.1	GPF (General Provident Fund)	1	2	3	4	5
33.2	CPF (Contributory Provident Fund)	1	2	3	4	5
33.3	Medical benefits	1	2	3	4	5
33.4	Accidental death benefits	1	2	3	4	5
33.5	Child allowances	1	2	3	4	5
33.6	Family benefits after retirement	1	2	3	4	5
Leave Benefits						
33.7	Maternity leave	1	2	3	4	5
33.8	Paternity leave	1	2	3	4	5
33.9	Medical leave	1	2	3	4	5
33.10	Study leave for higher education and development	1	2	3	4	5
33.11	Recreation leave with allowances	1	2	3	4	5
33.12	Mandatory leave (yearly)	1	2	3	4	5
33.13	Sabbatical leave (periodic leave)	1	2	3	4	5
33.14	Occasional leave : national, international, religious, sudden	1	2	3	4	5

PART-E: Working Environment/Ergonomics/Physical Variables/ QWL

34. Please tick (√) the following (any one of the boxes on right side for each particular).

1. Not at all true (NT) 2. A little true (LT) 3. Somewhat true (ST) 4. True (T) 5. Very much true (VT)

SL	Particulars	NT	LT	ST	T	VT
34.1	Workplace is congenial to health	1	2	3	4	5
34.2	Adequate space for movement, lighting and ventilation	1	2	3	4	5
34.3	Official equipment is updated/ sophisticated	1	2	3	4	5
34.4	Exist fire extinguisher is available in the bank branch	1	2	3	4	5
34.5	Child care unit	1	2	3	4	5
34.6	Female employees do not face sexual harassment	1	2	3	4	5
34.7	Internal environment affects the employee retention	1	2	3	4	5
34.8	Working environment affects the quality of working life	1	2	3	4	5

PART-F: Training and Employee Retention

35. Please tick (√) the following (any one of the boxes on right side for each particular).

1. Not at all true (NT) 2. A little true (LT) 3. Somewhat true (ST) 4. True (T) 5. Very much true (VT)

SL	Particulars	NT	LT	ST	T	VT
35.1	Presence of well-designed training policy in the bank	1	2	3	4	5
35.2	Top management tries to hunt future talent and utilize their potentialities through giving necessary training	1	2	3	4	5
35.3	Newly recruited employees are given induction training	1	2	3	4	5
35.4	Senior managers supervise and prepare their immediate juniors for taking future responsibilities	1	2	3	4	5
35.5	Employees training feedback is positive on performance	1	2	3	4	5
35.6	Job-rotation in the bank enhances employee development	1	2	3	4	5
35.7	Senior delegates authority and responsibility to juniors	1	2	3	4	5
Employee Retention (Long-term Employment)						
35.8	Training increases employees' commitment leading to low turnover and continuing job	1	2	3	4	5
35.9	Employee training provided by the bank increases retention	1	2	3	4	5
35.10	There is a sustainable training (creating action plans, HR cycle, reinforce learning, regular assessment etc.)	1	2	3	4	5

PART-G: HRD Environment

36. Please tick (√) the following (any one of the boxes on right side for each particular).

1. Strongly Disagree (SD) 2. Disagree (D) 3. Neutral (N) 4. Agree (A) 5. Strongly Agree (SA)

SL	Particulars	SD	D	N	A	SA
36.1	Top managers sense to ensure employees enjoy their work	1	2	3	4	5
36.2	Top management trusts that human resources are the most valuable asset for the bank	1	2	3	4	5
36.3	Managers observe HRD as their responsibility to develop subordinates within the bank	1	2	3	4	5
36.4	HRP within the bank make easy employee development	1	2	3	4	5
36.5	Succession plan is made for developing the employees	1	2	3	4	5
36.6	The managers believe that employee behavior can be changed and developed at any stage of their career	1	2	3	4	5
36.7	The culture is supportive to any employee interested in developing by acquiring new knowledge and skills.	1	2	3	4	5
36.8	HRD opportunities assist to satisfy the employees	1	2	3	4	5
36.9	Glass Ceiling: Female employees face obstacles to receive T&D opportunities in case of promotion/ EEO	1	2	3	4	5

PART-H: HRD Mechanisms or Sub-Systems or Instruments (Contributing indirectly to increase employee productivity)

37. Please tick (√) the following (any one of the boxes on right side for each particular).

1. Strongly Disagree (SD) 2. Disagree (D) 3. Neutral (N) 4. Agree (A) 5. Strongly Agree (SA)

SL	Particulars	SD	D	N	A	SA
37.1	There is a HRD Department in the bank as an unit	1	2	3	4	5
37.2	There is a mechanism of performance appraisal	1	2	3	4	5
37.3	Review discussions, communication and feedback, counseling and rewarding culture for better performance	1	2	3	4	5
37.4	Manager analyses the roles of the employees.	1	2	3	4	5
37.5	Training facility making future talent development	1	2	3	4	5
37.6	OD Exercise and changing culture	1	2	3	4	5

PART-I: HRD Processes & HRD Climate Variables with OCTAPACE (Eight) Culture

38. Please tick (√) the following (any one of the boxes on right side for each particular).`

1. Strongly Disagree (SD) 2. Disagree (D) 3. Neutral (N) 4. Agree (A) 5. Strongly Agree (SA)

SL	Particulars	SD	D	N	A	SA
38.1	Role clarity and clarification of norms and standards	1	2	3	4	5
38.2	Awareness of competencies required for job performance	1	2	3	4	5
38.3	Risk taking and fair rewarding culture	1	2	3	4	5
38.4	Investment on HRD	1	2	3	4	5
38.5	History and past culture of employees made impartially	1	2	3	4	5
OCTAPACE/Eight Culture						
38.6	Openness personality for various curiosity	1	2	3	4	5
38.7	Confrontation (bringing employee face to face for role efficiency, satisfaction, and attitude towards work)	1	2	3	4	5
38.8	Trust among colleagues through better communication	1	2	3	4	5
38.9	Autonomy	1	2	3	4	5
38.10	Proactive orientation is given by the bank	1	2	3	4	5
38.11	Authenticity and accountability in security with fact	1	2	3	4	5
38.12	Collaboration or work together with others (cooperation)	1	2	3	4	5
38.13	Experimentation for new projects and things	1	2	3	4	5

PART-J: HRD Outcomes Variables (Develop Employee and Organizational Effectiveness)

39. Please tick (√) the following (any one of the boxes on right side for each particular).

1. Strongly Disagree (SD) 2. Disagree (D) 3. Neutral (N) 4. Agree (A) 5. Strongly Agree (SA)

SL.	Employee Outcomes	SD	D	N	A	SA
39.1	More competent and work innovative employees	1	2	3	4	5
39.2	Better manpower development rates	1	2	3	4	5
39.3	High quality work commitment and performance	1	2	3	4	5
39.4	Problem solving skills leading to employee productivity	1	2	3	4	5
39.5	Better utilization of human resources	1	2	3	4	5
39.6	Higher job satisfaction and work motivation	1	2	3	4	5
Organizational Outcomes						
39.7	Generation of internal resources	1	2	3	4	5
39.8	Better organizational health and safety	1	2	3	4	5
39.9	Greater teamwork	1	2	3	4	5
39.10	Higher productivity	1	2	3	4	5
39.11	Growth and diversification	1	2	3	4	5
39.12	Less turnover, no loss time and cost reduction	1	2	3	4	5
39.13	Higher profits	1	2	3	4	5
39.14	Better image	1	2	3	4	5

PART- K: Performance Appraisal (PA)

40. Please tick (√) the following (any one of the boxes on right side for each particular).

1. Never (NV) 2. Sometimes (ST) 3. Often (O) 4. Very often (VO) 5. Always (AL)

SL.	Particulars	NV	ST	O	VO	AL
40.1	PA report is made based on management by objective(MBO)	1	2	3	4	5
40.2	There are mechanisms to reward any good work done or any contribution made by employees fairly	1	2	3	4	5
40.3	Employees are being promoted on time	1	2	3	4	5
40.4	Employees are being promoted based on seniority	1	2	3	4	5
40.5	Employees are promoted based on performance	1	2	3	4	5
40.6	Higher productivity is evaluated by the authority	1	2	3	4	5
40.7	Lower output of employees giving demotion/ transfer	1	2	3	4	5

PART-L: Management Practices

41. Please tick (√) the following (any one of the boxes on right side for each particular).

1. Strongly Disagree (SD) 2. Disagree (D) 3. Neutral (N) 4. Agree (A) 5. Strongly Agree (SA)

SL.	Particulars	SD	D	N	A	SA
41.1	Strategic Human Resource Planning (SHRP) practices	1	2	3	4	5
41.2	Fair recruitment and promotion systems	1	2	3	4	5
41.3	Job description and job specification	1	2	3	4	5
41.4	Academic qualification and job experience are valued	1	2	3	4	5
41.5	Involvement with Trade Union/ Association is allowed	1	2	3	4	5
41.6	Exist equality and equity among the employees	1	2	3	4	5
41.7	Employee retention policies (long-termed employment)	1	2	3	4	5

PART-M: Glass Ceiling Practices

SL.	Particulars	Yes=1			No=0	
42.1	Are the male and female equally treated?	Yes=1			No=0	
42.2	Do you think female's performance decreases due to family liabilities or burdens?	Yes=1			No=0	
42.3	Do you notice that there is any pay discrimination in case of gender?	Yes=1			No=0	
42.4	Job related logistic supports are equally distributed	SD	D	N	A	SA
42.5	Barrier to women advancement in the banking job	1	2	3	4	5
42.6	No discrimination in recruitment and selection	1	2	3	4	5
42.7	Discrimination in delegation of authority	1	2	3	4	5
42.8	Problem to assign women in the vital post	1	2	3	4	5

Thank you very much for your kind cooperation

Annexure VII: Published Articles from this Dissertation

ISSN 2522-9400

European Modern Studies Journal
available at journal-ems.com

Vol 4 No 5

Exploration of Effective Factors of the Employee Satisfaction and Motivation in the Banking Sector: A Study on Northern Region BangladeshMohammad Azizur Rahman¹¹PhD Fellow, IBS, RU, and ¹Associate Professor of Management Studies, Begum Rokeya University, Raugpur, Bangladesh, E-mail:azizru07@gmail.com

Abstract. The main aim of the present study was to extract the most effective factor of satisfaction employees in the service of banking sector. Employees either motivated or demotivated in the workplace depends on the association of job satisfaction factors such as pay, fair recruitment and selection, entertaining financial benefits, promotion, leave and career development opportunities. The study used Exploratory Factor Analysis (EFA) and one factor Structural Equation Modeling (SEM) for data explanation. Observed that KMO value was 0.834 and extracted 'promotion and transfer policy' as the loaded factor covering 51.50% (Eigenvalues 3.088) of the total variance explained. In the SEM satisfaction was supposed as the latent factor with beta coefficient value is 0.079 indicating relationship with employee motivation. The existing employees were highly satisfied with the recruitment and selection (highest mean value 4.015) systems of the banking organization. Researcher observed that employees were highly satisfied with present pay, staffing, financial benefits and career development and they were moderately satisfied with the promotion and transfer and leave policy. Finally, researcher found a strong effective factor of the latent variable influencing the promotion and transfer policy ($\beta=2.229$, i.e., >1) as the correlation of satisfaction and motivation of existing employees working in the bank.

Key words: Satisfaction, motivation, benefits, career and development path

Introduction and research context

According to the thought (Malik, 2011) of job satisfaction is very much intangible and multifarious and even speaks out of various concepts to be inexpressible and mythological. The fundamental principles essentialities of job satisfaction and motivation are closely related to each other, and to adoptive an operative and creative workstation the two concepts should not be separated (supported by Mowday et al., 1982; Mathieu and Zajac, 1990; Chen and Francesco, 2003; Tziner et al., 2008). Job satisfaction is the degree of content of an individual's feelings regarding his job done. This feeling must be considered the perception on satisfaction. It is a positive emotional state resulting from the evaluation of one's job experience (Robbinson & Judge, 2013). A high level of satisfaction represents positive attitudes of a job done. Satisfaction is a function of the counterpart between the rewards offered by working condition and employees' priorities for those rewards. Satisfaction is an emotional response resulting in big behavioral actions towards working environment; whereas, motivation is a behavioral action that may return with specific emotional response (Love & Edward, 2005). Hence, it can say differently as job satisfaction is an approach gathered from objects; whereas, motivation is a behavior headed for recognized objects. Job involvement means interrelation to job satisfaction (Diefendorff, 2002) determines the degree to which people detect psychologically with their jobs and deliberate their perceived performance level of importance to self-worth (Blau & Boal 1987). High job satisfaction indicates a strong correlation between an employee's expectations of the rewards obtained from doing a job. Employees those who are satisfied with their job could be more cooperative and motivated. And those who are dissatisfied would be persuaded to produce lose quality output, call for strike, absenteeism, and grievance or even switch the organization as

well. Job Satisfaction and OCB (Podsakoff et al, 2000) appear reasonable to adopt job satisfaction should be the main determinant of an employee's organizational citizenship behavior (OCB). Highly pleased employees would seem more prospective to talk confidently about their organization, help others, and go elsewhere the normal expectations in their job, maybe cause they would like to share their positive familiarities. Depending on this philosophy, indication suggests job satisfaction is moderately correlated with OCBs; people who are more satisfied with their jobs are more probable to involve in OCBs (Hoffman et al, 2007). Questions may be raised, why? Fairness insights help explains the relationship (Blader & Tyler, 2009). Those who feel their co-workers support them are more likely to engage in helpful behaviors, whereas those who have antagonistic relationships with coworkers are less likely to do so (Chiaburu & Harrison, 2008). It also shows that the more satisfaction the more output leading them to involve in more OCBs (Ilies et al, 2009). Lastly, different shows that when the existing employees are in respectable mode, they are more likely to absorb with environment where the OCBs practices (Ilies, Scott & Judge, 2006). Motivation is a collaborative process influencing the inner needs or drives that energize, channel and maintain behavior (Griffin, 2008). Over the many years huge number of research conducted on motivation and job satisfaction. Noticeable researchers evaluate the Herzberg's Two-Factor Theory as the preeminent the general study inclinations on the title concerning the range of job satisfaction theories that include F W Taylor's Scientific Management, Hawthorn Studies, and Maslow's Need Hierarchy Model (Herzberg, Mauser & Snyderman, 1959). In Pittsburg and Pennsylvania explored the indicators responsible for satisfaction and dissatisfaction by taking interview from the workers (Herzberg et el, 1987 and 2003). According to earlier studies concerning motivation and job satisfaction, it is perceptible that motivation and satisfaction are closely related. Study signified on extrinsic motivators (hygiene) that there is a strong association with job satisfaction in the context of military foodservice operations. Similarly, the research displayed a more positive relationship between intrinsic motivators and job satisfaction. It was observed in the other study that extrinsic factors are more significant than intrinsic motivational factors in the hospital management (Likert, 1961; Mc GcGregor, 1960). The studies found in the different context of the researchers that the more satisfaction lies on intrinsic nonmonetary affect the nature of the job, good social relationships with supervisors, promotion, professional development and participation in strategic decision making both for public and private organization (Kim, 2002; Ellickson, 2002; Wright & Davis, 2003; Borzaga & Tortia, 2006). A negative perception of existing employees affects the organizational performance reducing sales volume and ultimately influences the holistic management. It is possible to occupy the competitive advantage with maintaining strong satisfaction level of existing employees (Schneider & Bowen, 1993). Zlate (2007) clearly indicated about the interaction between motivation and satisfaction. He explained motivation as indication the status of satisfaction or dissatisfaction. These two terms perform a double capacity, the cause and effect of which means that motivation leads to satisfaction and vice-versa. The banks' employees are the most valuable HR contributing to the financial performances of the nation with a view to gearing up the economic condition. It is the toughest job to determine the employee's satisfaction. Many of the employees may be satisfied with the financial benefits and many others be satisfied with non-financial opportunities they enjoy. This is why, it is very much critical situation and responsible for the authority concern to motivate the existing employees in the banking organization. Motivation helps employees to content their jobs resulting from maximum output. Substantial responsiveness has been specified to the measurement of job satisfaction. Job Diagnostic Inventory (JDI), the measurement of job satisfaction was developed since 1969. JDI tool includes the work itself, pay, supervision, and opportunities for upgradation (Smith, Kendall & Hulin, 1969). On the basis of Two-Factor theory of

motivation as stated by Herzberg researchers used the Monnesota Satisfaction Questionnaire (MSQ) for determining job satisfaction. There are two forms of MSQ instrument of measuring satisfaction. The long-form of MSQ was applied by Walsh (1980) to consider the satisfaction of for house hall service employees. Short-form MSQ was used by DecMicco and Olsen (1987) to find out how job satisfaction exaggerated retirement meaning in older personnel. Researchers applied the Job Satisfaction Survey (JSS), the nature of job, supervision, co-workers, and promotion for evaluating satisfaction of institutional foodservice supervisors (Gilmore & Vyskocil-Czajkowski, 1992). The single significant difference was found in the division of rewards into pay, benefits and contingent rewards on JSS. By applying JSS scale point researchers examined job satisfaction of the hospital employees both in managerial and non-managerial posts. The most significant findings of the study found that satisfaction with the nature of work done had the strongest correlation with whole satisfaction.

A study examines how motivation is related to job satisfaction (Singh & Vivek, 2011). In determining the relationship between motivation and satisfaction, a structured questionnaire has been used. The findings of the study demonstrate a positive relationship between motivation and satisfaction whereas motivation is induced due to age and length of the service. Moe importantly compensation package plays vital role for job satisfaction but self-actualization is least important for job satisfaction. Job satisfaction stimulates productivity and thereby enhances organizational performance (Aziri, 2011). Study one proposed that job satisfaction has mediating impact of job security on organizational commitment whereas study two recommends that are relationship between job security and withdrawal cognitions are mediated by job satisfaction and commitment (Jeanette, 1997). Another study analyzes the relationship between work motivation and job satisfaction in the banking sector in Pakistan (Nadia & Shagufta, 2011). The study findings illustrate that there is a positive association between work motivation and satisfaction and a noticeable gender differences on the work motivation and job satisfaction variables. A study conducted on employee motivation revealed that except for fringe benefits and social status along with other motivational factors are significantly difference between public and private banking employees they are entertained (Qayyum et al, 2011). The benefits of public bank are more than the private bank due to availability of job security, flexible work environment, balanced and family life and having family benefits after retirement. In contrast, individual development, high salary packages, chances of getting advancement, seniority based promotion, opportunity to contribute society were carefully considered more to private bank than public bank employees. Another study aimed to assess the level of satisfaction and largely socio-economic satisfaction of women bank employees in Bangladesh and focused relatively on the substantial factors of job satisfaction (Islam, 2003). It showed the overall relationship among employees in the bank. The study findings concludes that attitudinal factors towards job satisfaction are suggestively association with the completely satisfaction of the women bank employees in Bangladesh. Study (Hoque & Jahan, 1996) conducted on the employees' job satisfaction and motivation of the commercial bank in Bangladesh and showed that motivation had significant effect on job performance. The study found that a significant different between financial and non-financial incentives. The researchers observed that non-financial incentives such as appreciation by immediate manager and colleagues in the workplace were more significant than financial incentives namely high salary, bonuses, allowances and other financial benefits. Luthans (2007) showed the variation of promotion affecting job satisfaction in the work and its nature. Author mentioned the main cause of varying promotion and its formalities required to form a variety of accompanying rewards. Individual growth and advancement depend on the promotion on time that affects personal satisfaction and social esteem. An employee who recognizes that promotion is fairly given

among employees is probable to gather satisfaction as well (Witt & Nye, 1992). Haque (2011) investigated the factors determining employee motivation on the commercial banks of Bangladesh. The main focus of the study was to identify the overall motivation level of the bank officials in Bangladesh and attempted to explore effective factors related to overall satisfaction of bank officials.

Scope of the Study

The main concentration of the present study is satisfaction and motivation of the employees in the service of the banking industries of Bangladesh. The study strived to outline the present environment regarding motivation and satisfaction in the bank. The detected factors of motivation leading to satisfaction would be worthy to the authority concern or HR professionals of the respective banking organization and well known how to mitigate the low level satisfaction. The findings of the study will be applicable for the policy makers to launch new opportunities and take strategic decisions in this regard. It will be more supportive to improve performance, efficiency and productivity of the existing employees and give best service to the respective banking industry. Finally, banking sector will enhance scale of operations. It can be concluded that there will create a platform for further study and continue at the same level of performance as well. The main purpose of the study is to explore the motivational indicators leading to job satisfaction in the banking sector of Bangladesh.

Research Questions

1. How much level of satisfaction exists among employees related to motivation?
2. How does job satisfaction exist with compare to both public and private bank?
3. What is the most effective indicator influencing employee satisfaction and motivation?

Objectives of the Study

The main purpose of the study was to show the correlation between job satisfaction and motivation of the employees in the banking sector of Bangladesh. The following specific objectives are set:

1. to show the present status of job satisfaction among employees of the sampled banks.
2. to detect the most effective indicators of employees' motivation leading to job satisfaction in the banking sector of Bangladesh and suggest to mitigate dissatisfaction.

Methods

Total number of branches (Bangladesh Bank, 2018) was 359 (N) in the study enclosed three districts: Rangpur, Dinajpur and Nilphamari, the required number of sample branches (n_0) has been selected using simple random sampling (SRS) and random number table without replacement. It covers $n_0/N=96/359*100=26.75\%$ branches of the study area. Selecting 4 employees from each branch the total number of participants is $(96*4) = 384$. In addition, 4 (four) employees from divisional offices of SBL, JBL, ABL and RAKUB in Rangpur of the public banks are selected so that the sampled number of branches is rounding up 400. The ratio of branches and participants between public and private bank is 80:20 and 320:80 respectively. The primary data were collected from employees of the ten banks holding different designation through Likert's five scale structured questionnaire and explored the obtained data with IBM SPSS 22.0 version and for SEM used Stata version 13. Secondary information collected from different journals, articles, books and dailies. Primary data were collected from the branches of the bank during March-June 2019.

Results and Discussion

Table 1. Demographic composition of the respondents 2019

		Percent			Percent
Gender	Male	83.5%	Field of Education	Science	31.8%
	Female	16.5%		Hum(.5)+ Busi (18.3)	68.3%
Age	<30 years	04.0%	Banking Diploma	Nil	62.3%
	31-40 years	55.5%		Part-1	21.3%
	41-50 years	13.8%		Part-2	16.5%
	Above 50 years	26.8%		1-5 yrs	11.3%
Religion	Islam	89.0%	Experience	6-10 yrs	45.5%
	Hindu	11.0%		11-15 yrs	08.0%
Bank	Public	80.0%		16-20 yrs	04.0%
	Private	20.0%		20+ years	31.3%
Edu.Qualification	Bachelor	17.0%	Source: Field Survey on Bank Branches		
	Master	83.0%			

Primary Data Analysis

Employees' perception regarding satisfaction and motivation in the banking sector and observations are discussed below.

Table 2. Satisfaction level with present salary

Perception	Freq.	%	Remarks
Dissatisfied	1	0.3	Researcher (Table 2) observed that 71.3% (majority) of the employees felt satisfaction on their salary. About 27% of the respondents moderately satisfied with their present pay.
Moderately satisfied	106	26.5	
Satisfied	285	71.3	
Strongly satisfied	8	2.0	
Total	400	100.0	

Table 3. Satisfaction in recruitment and selection

Perception	Freq.	%	Remarks
Moderately satisfied	20	5.0	It was perceived (Table 3) that 88.5% of the participants pleased with recruitment and selection systems.
Satisfied	354	88.5	
Strongly satisfied	26	6.5	
Total	400	100.0	

Table 4. Satisfaction on financial benefits

Perception	Freq.	%	Remarks
Dissatisfied	2	0.5	It was observed (Table 4) that 69.8% of the participants satisfied with financial benefits they enjoyed. About 29% employees were judiciously satisfied regarding the financial benefits entertained.
Moderately satisfied	115	28.8	
Satisfied	279	69.8	
Strongly satisfied	4	1.0	
Total	400	100.0	

Table 5. Satisfaction on promotion and transfer policy

Perception	Freq.	%	Remarks
Strongly dissatisfied	1	0.3	It was perceived from Table 5 that majority (44% and 40.3%) of the employees of the banking sector moderately pleased and generally satisfied
Dissatisfied	57	14.3	
Moderately satisfied	176	44.0	

Satisfied	161	40.3	with the existing promotion and transfer policy.
Strongly satisfied	5	1.3	
Total	400	100.0	

Table 6. Satisfaction on leave policy

Perception	Freq.	%	Remarks
Dissatisfied	2	0.5	From the Table 6 the study found that 54.3% and 44% of the participants moderately and normally satisfied with the leave policy existence in the banking industry in Bangladesh. Leave policy of the banking sector is strictly maintained.
Moderately satisfied	217	54.3	
Satisfied	176	44.0	
Strongly satisfied	5	1.3	
Total	400	100.0	

Table 7. Motivation on career and development paths

Perception	Freq.	%	Remarks
Dissatisfied	5	1.3	It was observed (Table 7) that majority (55.8% normally and 39.5% moderately satisfied) of the employees in the banking sector of Bangladesh pleased on career and development paths they enjoyed.
Moderately satisfied	158	39.5	
Satisfied	223	55.8	
Strongly satisfied	14	3.5	
Total	400	100.0	

Table 8. Scores of high and low motivation and job satisfaction (>median=200; .5)

Variables	High	Moderate	Low	Remarks on scenario
Present pay	293 (73.3)	106 (26.5%)	1 (0.3)	Bank employees highly satisfied regarding pay, R&S and financial benefits was perceived.
R & S	380 (95%)	20 (5%)	0 (0%)	
Financial benefits	281 (70.8%)	115 (28.8%)	2 (0.5%)	
Promotion & Transfer	166 (41.3%)	176* (44%)	58 (14.6%)	***Moderate level satisfaction among employees on promotion and leave policy was observed.
Leave policy	181 (45.3%)	217** (54.3%)	2 (0.5%)	
Career development	237 (59.3%)	158 (39.5%)	5 (1.3%)	High level satisfaction on career and development

Source: Primary data, March-June 2019; developed by researcher

Table 9. Correlation of satisfaction between public and private bank (crosstabs)

Employee perception on Satisfaction	Type of Bank		Test statistic p value and hypothesized results
	Public N=320	Private N=80	
Satisfaction on present salary/pay			
Dissatisfied	0 (0%)	1 (1.25%)	Observed that p=0.045. Alternative hypothesis (H _a) accepted. An association was existed.
Moderately	82 (25%)	24 (30%)	
Satisfied	234 (73.13%)	51 (63.75%)	
Strongly satisfied	4 (1.25%)	4 (5%)	
Satisfaction on recruitment & selection (R & S)			
Moderately	13 (9.38%)	7 (8.75%)	Since p=0.02. Relationship of satisfaction between R & S and
Satisfied	282 (77.66%)	72 (90%)	

Strongly satisfied	25 (7.81%)	1 (1.25%)	type of bank sustained.
Satisfaction on financial benefits respective banking organizations			
Dissatisfied	1 (0.31%)	1 (1.25%)	Since p =0.39; H _a not supported. Association exists between financial benefits and bank type.
Moderately	87 (27.19%)	28 (35%)	
Satisfied	229 (71.56%)	50 (62.50%)	
Strongly satisfied	3 (0.94%)	1 (1.25%)	
Satisfaction on promotion and transfer policy of the sampled banks			
Strongly Dissatis.	1 (0.31%)	0 (0%)	Got p value 0.05. H _a failed to reject. There is positive relationship in case of satisfaction between promotion policy and type of bank.
Dissatisfied	52 (16.25%)	5 (6.25%)	
Moderately	131 (40.94%)	45 (56.25%)	
Satisfied	132 (41.25%)	29 (36.25%)	
Strongly satisfied	4 (1.25%)	1(1.25%)	
Satisfaction on leave policy of the sampled banks			
Dissatisfied	2 (0.63%)	0 (0%)	Since p=0.79 H _a not accepted. There is no relationship in case of satisfaction between leave policy and type of bank.
Moderately	175 (54.69%)	42 (52.50%)	
Satisfied	139 (43.44%)	37 (46.25%)	
Strongly satisfied	4 (1.25%)	1(1.25%)	
Motivation regarding banking career & development (C&D) paths			
Dissatisfied	5 (1.56%)	0 (0%)	Got p=0.24; No positive relationship regarding otivation between C&D and bank type.
Moderately	122 (38.13%)	36 (45%)	
Satisfied	183 (57.19%)	40 (50%)	
Strongly satisfied	10 (3.13%)	4 (5%)	

Table 10. Status of satisfaction and motivation between public and private bank

Satisfaction on	Public Bank		Private Bank		Levene's Test for Equality of Means				Status
	Mean	SD	Mean	SD	MD	F	Sig.	Sig. diff.	
Present pay	3.76	0.46	3.73	0.57	0.03	7.86	0.61	Pub>Pri	Slightly differences
R & S*	4.04	0.34	3.92	0.31	0.12	0.09	0.01	Pub>Pri	
Finan_ benefits	3.73	0.47	3.64	0.53	0.09	7.52	0.12	Pub>Pri	
PromoTransfer**	3.27	0.75	3.33	0.61	-0.06	6.26	0.01	Pri> Pub	
Leave policy	3.45	0.53	3.49	0.53	-0.04	0.01	0.91	Pri> Pub	
Career_develop**	3.62	0.58	3.60	0.59	0.02	0.36	0.80	Pub>Pri	
Overall_satis***	3.65	0.52	3.62	0.52	0.03	3.68	0.41	Not sig.	

Infer: MD = Mean Difference; SD = Standard Deviation; 95% Conf. Interval of the Difference; Sig. (2-tailed). Compiled by researcher.

From Table 10 the study observed that there was a slightly difference of satisfaction and motivation level among the employees in both banks. Overall, mean value of job satisfaction of public bank* is more than the private bank was noticed (MD is 0.03 and constant in SD 0.52). Recruitment and selection (R&S) and promotion and leave policy were statistically significant since p value <0.05.

Table 11. Exploratory Factor Analysis: Satisfaction and motivation of existing opportunities: KMO and Bartlett's Test of Sphericity (Primary data)

Descriptive Statistics: Satisfaction and motivation	Mean	SD	Test result
Present salary (Present_salary)	3.750	0.483	KMO=0.834 χ ² =758.033 df.=15
Recruitment and selection (R&S)	4.015	0.339	
Financial benefits (Fin_benefits)	3.713	0.485	

Promotion and transfer policy (Promo_trans)	3.280	0.727	Sig.=0.000 N=400 Cron_Alpha .81
Leave policy (leave policy)	3.460	0.533	
Career and development paths (Career_deve)	3.615	0.577	

The Table 11 depicts that the sampling adequacy is explained by applying KMO. The KMO value is 0.834 which is fit and suitable for EFA with Principal Component Analysis (PCA) method. In addition, Bartlett's Test of Sphericity is used to determine data for normal multivariate distribution. The output is significant at $p < 0.05$, so it can meet the proposition of normal multivariate analysis and distribution. The mean values of the above factor are > 3.00 meaning that level of satisfaction are reasonably true in the sampled banks. It was observed that the employees are highly satisfied with recruitment and selection policy (MV is 4.015).

Table 12. Total Variance Explained: Satisfaction and motivation

Communalities: Satisfaction and motivation among bank employees			Total Variance Explained				Remarks on loadings
		Initial (1.00) Eigenvalues		Extraction Sums of Squared Loadings			
Components	Initial	Extraction	Total	% of Variance	Total (>)		% of Variance
1. Promo_trans	1.000	0.658	3.088	51.459	3.088	51.459	Loaded
2. Career_deve	1.000	0.480	0.928	15.463	-	-	51.50%
3. Leave policy	1.000	0.398~0.40	0.735	12.245	-	-	-
4. Fin_benefits*	1.000	0.335<0.40	0.475	7.909	-	-	-
5. Present salary**	1.000	0.300<0.40	0.438	7.306	-	-	-
6. R&S***	1.000	0.089<0.40	0.337	5.618	-	-	-

*****&*** Extraction < 0.40. Total variance explained and loaded covering (1) ~51.50%**
Compiled by author by using EFA with Principal Component Analysis (PCA)

Table 12 shows that extraction values of three components are more than 40% the communality values from 1 to 3 components are > 0.40 out of six factors. There is only one factor with Eigenvalues (satisfaction on promotion was **3.089**) more than **1.00**. That means, this component was highly loaded and covered **~51.50%** of the total variance explained as Eigenvalues for employee satisfaction. Therefore, employees were not satisfied strongly with the promotion and transfer policy in the sampled banks. Moreover, career development, leave policy and financial benefits should rethink by the policy maker of the sampled banking organization. Employees are highly satisfied with the recruitment and selection policy was observed.

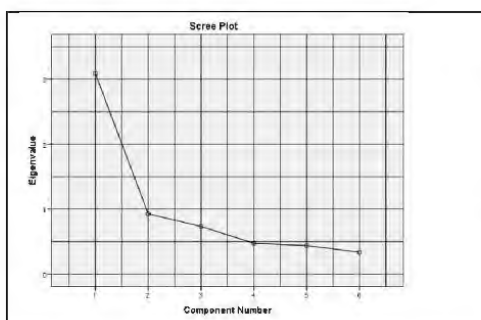

Figure 1 displays the scree of eigenvalues and depicting two factors are creating elbow shape and maximum percentage variance is explained in the graph. The top three communalities have been extracted i.e., promotion, career development and leave policy are the most significant for ensuring maximum satisfaction among the employees.

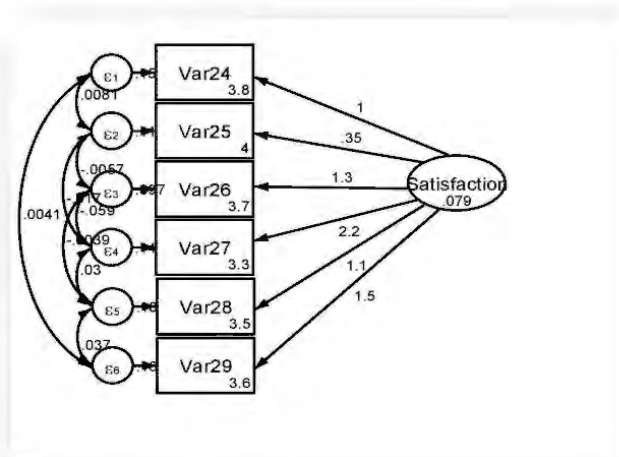

Figure 2. SEM: Employee satisfaction and motivation in the hanking sector of Bangladesh

Table 13. SEM: (Employee satisfaction) Number of obs = 400; Estimation method = ml; Log likelihood = -1413.7181; LR test of model vs. saturated: chi2(15) = 13.09, Prob > chi2 = 0.0003

Particulars (Measurement)	Coef.	Std. Err.	z	p>z	95% Conf. Interval	
Employee satisfaction in the sampled banking organization						
Var24 (Present_salary)	<-					
	1	(constrained)				
_cons	3.75	0.024	155.54	0.000	3.703	3.797
Var25 (R&S)	<-					
	0.35	0.104	3.37	0.001	0.147	0.556
_cons	4.015	0.017	237.09	0.000	3.982	4.048
Var26 (Fin_benefits)	<-					
	1.33	0.365	3.63	0.000	0.610	2.043
_cons	3.713	0.024	153.22	0.000	3.665	3.759
Var27 (Promo_transfer)	<-					
	2.229	0.612	3.64	0.000	1.030	3.428
_cons	3.28	0.036	90.40	0.000	3.209	3.351
Var28 (Leave policy)	<-					
	1.12	0.299	3.73	0.000	0.530	1.705
_cons	3.46	0.027	130.19	0.000	3.408	3.512
Var29 (Career_deve)	<-					
	1.49	0.133	11.18	0.000	1.230	1.753
_cons	3.62	0.029	125.52	0.000	3.558	3.671
var(e.Var24)	0.154	0.023			0.114	0.208
var(e.Var25)	0.105	0.008			0.090	0.122
var(e.Var26)	0.097	0.038			0.045	0.209
var(e.Var27)	0.136	0.104			0.031	0.608
var(e.Var28)	0.184	0.029			0.135	0.252
var(e.Var29)	0.157	0.047			0.088	0.281

<i>var (Emplo_satisfaction)</i>	0.079	0.024			0.043	0.144
cov(e.Var24,e.Var25)	0.008	0.008	1.02	0.308	-0.007	0.024
cov(e.Var24,e.Var29)	0.004	0.031	0.14	0.892	-0.056	0.064
cov(e.Var25,e.Var26)	-0.006	0.010	-0.55	0.580	-0.026	0.014
cov(e.Var25,e.Var27)	-0.017	0.015	-1.15	0.250	-0.047	0.012
cov(e.Var26,e.Var27)	-0.059	0.061	-0.97	0.334	-0.179	0.061
cov(e.Var26,e.Var28)	-0.004	0.029	-0.13	0.895	-0.062	0.055
cov(e.Var27,e.Var28)	0.030	0.050	0.60	0.546	-0.068	0.128
cov(e.Var28,e.Var29)	0.037	0.015	2.45	0.014	0.007	0.066

The above Table 13 shows information on how the SEM is specified by listing the observed variables with coefficient values of latent factor *Employee satisfaction* ($\beta=0.079$) are satisfaction on salary ($\beta=1$ constrained), recruitment and selection ($\beta=0.35,<1$), financial benefits ($\beta=1.33$ i.e., >1), promotion and transfer policy ($\beta=2.229,>1$), HR leave policy ($\beta=1.12, >1$), and career and development path ($\beta=1.49,>1$). The Stata is estimating the model that projected with the intended sample. In the main part of the output, the columns are the same as those presented for regression model. The rows present the standardized factor loadings, intercepts, and measurement error variances. The most important information in the remainder of this part of the output is the standardized factor loadings listed in the Coef. Column and the corresponding p-values listed in the P>|z| column. The p-values for all of the factor loadings are below the typical cut-off of .05, leading to the rejection of the null hypotheses that the factor loadings are equal to 0; hence, the factor loadings are statistically significant. Their degrees need to be interpreted to assess their applicability significance.

We get identical factor loadings because the variance for *Employee satisfaction* was set to 1 to scale the latent variable and for model identification. The standardized factor loading for the promotion and transfer policy variable and coefficient value is 2.229 which is >1 , meaning that standard deviation increases in *satisfaction* leads to a 2.229. HR promotion and transfer is the most effective factor in the SEM for employee satisfaction. The coefficient values of other factors that near to 1 or >1 leading the model effective. The remaining of the said HR promotion and transfer less effective factor to the model since beta coefficient is $0.35 <1$. The model chi-square value, $\chi^2(15) = 13.09$, Prob > chi2 = 0.0003, is highly statistically significant (p value <0.05) indicating the model reproduces the observed covariance among all factors very well. The null hypothesis is that the model fits perfectly. The p-value of 0.000 is less than .05, the typical cut-off for the test, which means that the null hypothesis is rejected and the model turns well. The overall model fits extremely well meaning that the latent variable specified as *employee satisfaction* strongly supplementary to the all factors applied to measure it. The output also provides with the chi-square value of 13.09, with the degree of freedom 15, and the significance of the chi-square test (i.e. $p <0.001$). The equation may Employee Motivation: Employee satisfaction = α (constrained: present salary) + β_1 (Satisfaction on recruitment and selection) + β_2 (Financial benefits) + β_3 (Promotion and transfer) + β_4 (Leave policy) + β_5 (Career and development path) + e. Therefore, Employee Motivation = f (Employee satisfaction).

Table 14. Structural path analysis: There is correlation between satisfaction and employee motivation in the sampled banks (developed from Table 13)

Hypothesized Structural Path	p value	Coeff	Relationship	Remarks
Motivation← Satisfaction	0.000	0.079	Hal; sustained	Highly related
Log likelihood = -1413.7181; LR test of model vs. saturated: $\chi^2(15) = 13.09$, Prob > chi2 = 0.0003. Std. Error = 0.024; 95% Conf. Interval between 0.043 and 0.144.				

Result of Hypothesis

Therefore, there is a strong association between employee satisfaction and motivation in the sampled banks. The alternative hypothesis is continued since p value is <0.05 .

Concluding Remarks

It can be concluded that employee promotion and transfer policy highly affect employee satisfaction and motivation. The bank authority or HR professional may consider the overall fringe benefits whereas study leave, more occasional leave and other leave policies. Since banking operations is now a challenging issue this is why HR department or strategic unit of HRD can develop the nature of the job as well as enrichment for avoiding affective reactions from the existing employees. On the other hand, bank employees should consider the situation of the challenges to sustain in the competitive arena. The adoptive policies of the job responsibilities should be developed for satisfaction and motivation.

Acknowledgement

The author is indebted to honorable Professor Dr. Md. Omar Faruk Sarker (PhD Supervisor of the author), Marketing Department, & Dr. Md. Kamruzzaman (PhD Co-Supervisor of the author), Associate Professor, IBS, University of Rajshahi.

References

- Aziri, B. (2011). Job Satisfaction: A Literature Review. *Management Research and Practice*, 3(4), 77-86.
- Bangladesh Bank, Rangpur Office, February 2018.
- Blader, S.L., & Tyler, T.R. (2009). Testing and Extending the Group Engagement Model: Linkages Between Social Identity, Procedural Justice, Economic Outcomes, and Extra role Behavior. *Journal of Applied Psychology*, 94(2), 445-464.
- Blau, G.j., & Boal, K.R. (1987). Conceptualizing how Job Involvement and Organizational Commitment Affect Turnover and Absenteeism. *Academy of Management Review*, 290.
- Borzaga, C., & Tortia, E. (2006). Worker motivations, job satisfaction, and loyalty in public and non-profit social services. *Nonprofit and Voluntary Sector Quarterly*, 35, 225-248. <http://dx.doi.org/10.1177/0899764006287207>.
- Chen, Z.X., & Francesco, C. (2003). The relationship between the three components of commitment and employee performance in China. *Journal of Vocational Behavior*, 62(3), 490-510.
- Chiaburu, D.S., & Harrison, D.A. (2008). Do Peers Make the Place? Conceptual Synthesis and Meta-Analysis of Coworker Effect on Perceptions, Attitudes, OCBs, and Performance. *Journal of Applied Psychology*, 93(5), 1082-1103.
- Davy, J. A., Kinicki, A. J., & Scheck, C. L. (1997). A test of job security's direct and mediated effects on withdrawal cognitions. *Journal of Organizational Behavior: The International Journal of Industrial, Occupational and Organizational Psychology and Behavior*, 18(4), 323-349.
- DeMicco, F., & Olsen, M. (1987). The relationship of job attitudes to retirement intention of older foodservice employees. *Hospitality Education and Research Journal*, 11(2), 275-286.
- Ellickson, M., & Logsdon, K. (2001). Determinants of job satisfaction of municipal government employees. *State and Local Government Review*, 33(3), 173-184. <http://dx.doi.org/10.1177/0160323X0103300302>.
- Gilmore, S.A., & Vyskocil-Czajkowski, T.I. (1992). Job satisfaction of selected institutional foodservice supervisors. *Journal of Foodservice Systems*, 7(1), 29.

- Griffin, R.W. (2008). *Management*. 9th ed. (pp. 666-670). Massachusetts: Houghton Mifflin.
- Haque, M.M. (2011). Determining Motivation Level of Bank Employees: A Study on Selected Commercial Banks in Bangladesh. *Bank Parikrama*, Vol. XXXVI, 89-106.
- Herzberg, F. (1987). One more time: How do you motivate employees? *Harvard Business Review*, 65(5), 109-120.
- Herzberg, F. (2003). One more time: How do you motivate employees? *Harvard Business Review*, 81(1), 86-97.
- Herzberg, F., Mausner, B., & Snyderman, B.B. (1959). *The Motivation to Work*. New York, NY: Wiley.
- Hoffman, B., J., Blair, C., A., Maeriac, J., P., & Woehr, D., J. (2007). Expanding the Criterion Domain? A Quantitative Review of the OCB Literature. *Journal of Applied Psychology*, 92(2), 555-566.
- Hoque, E., & Sarwar, J. (1996). Work motivation and Job Performance of Employees of Commercial Banks. *Journal of Business Administration*, 22(1 & 2).
- Ilies, R., Fulmer, I.S., Spitzmuller, M., & Johnson, M.D. (2009). Personality and Citizenship Behavior: The Mediating Role of Job Satisfaction. *Journal of Applied Psychology*, 94, 945-959.
- Ilies, R., Scott, B.A., & Judge, T.A. (2006). The Interactive Effects of Personal Traits and Experienced States on Intraindividual Patterns of Citizenship Behavior. *Academy of Management Journal*, 49, 561-575.
- Kim, S. (2002). Participative management and job satisfaction: Lessons for management leadership. *Public Administration Review*, 62, 231-241. <http://dx.doi.org/10.1111/0033-3352.00173>.
- Kim, S. (2004). Factors affection state government information technology employee turnover intentions. *American Review of Public Administration*, 35, 137-156. <http://dx.doi.org/10.1177/0275074004273150>.
- Likert, R. (1961). *New Pattern of Management*. International Students' Edition. Tokyo: McGraw-Hill.
- Love, P.E.D., & Edwards, D.J. (2005). Taking the pulse of UK construction project managers' health: Influence of job demands, job control and social support on psychological wellbeing. *Engineering, Construction and Architectural Management*, 12(1), 88-101.
- Luthans, F. (2007). *Organizational Behavior*. 12th ed. (pp. 143-163). Singapore: Irwin/McGraw-Hill.
- Malik, N. (2011). Study on job satisfaction factors of faculty members at university of Balochistan. *International Journal of Academic Research*, 3(1), Part I.
- Mathieu, J., & Zajac, D. (1990). A review and meta-analysis of the antecedents, correlates and consequences of organizational commitment. *Psychological Bulletin*, 108(2), 171-94. <http://dx.doi.org/10.1037/0033-2909.108.2.171>.
- McGregor, D. (1960). *The Human Side of Enterprize*. New York: McGraw-Hill.
- Mowday, R., Porter, L., & Steers, R. (1982). *Employee-Orientation Linkages: The Psychology of Commitment, Absenteeism and Turnover*. New York: Academic Press.
- Nadia, A., & Shagufta, R. (2011). The Relationship between Work Motivation and Job Satisfaction. *Pakistan Journal of Business Review*, 13(2).
- Podsakoff, P., MacKenzie, S.B., Paine, B., & Bachrach, D.G. (2000). Organizational Citizenship Behaviors: A Critical Review of the Theoretical and Empirical Literature and Suggestions for Future Research. *Journal of Management*, 26(3), 513-563.
- Qayyum, A., Sukirna, & Mahmood, A. (2011). A Preliminary Investigation of Employee Motivation in Pakistan's Banking Sector. *Research and Practice in Human Resource Management* (pp. 38-52). Singapore.

- Robbins, S.P., & Judge, T.A. (2013). *Organizational Behavior*. 15th ed. Pearson Education Inc., Prentice Hall.
- Schneider, B., & Bowen, D. (1993). The service organization: Human resources management is crucial. *Organizational Dynamics*, 21(4), 39-43.
- Singh, S.K. & Tiwari Vivek (2011). Relationship between Motivation and Job Satisfaction of the White Collar Employees: A Case Study. *Management Insight*, VII(2), 31-39.
- Smith, j., Kendall, L., & Hulin, C. (1969). *The measurement of satisfaction in work and retirement*. Chicago: Rand McNally.
- Tziner, A., Manor, R.W., Vardl, N., & Brodman, A. (2008). The personality dispositional approach to job satisfaction and organizational commitment. *Psychological Reports*, 103, 435-42.
- Walsh, T. E. (1980). Job satisfaction assessment of residence hall foodservice personnel at three selected state universities. *National Association of College and University Foodservice Journal*, 8, 9-16.
- Witt, L.A. & Nye, L.G. (1992). Gender and the Relationship between Perceived fairness of pay or Promotion and Job Satisfaction. *Journal of Applied Psychology*, 77(6), 910-917.
- Wright, B. E., & Davis, B. S. (2003). Job satisfaction in the public sector: The role of the work environment. *American Review of Public Administration*, 33, 70-90. <http://dx.doi.org/10.1177/0275074002250254>.
- Zlate, M. (2007). *Tratat de Pshologie organizational-manageriala* (Vol. II, pp. 387-389). Iasi: Editura Polirom.



GLOBAL JOURNAL OF MANAGEMENT AND BUSINESS RESEARCH: A
ADMINISTRATION AND MANAGEMENT
Volume 20 Issue 13 Version 1.0 Year 2020
Type: Double Blind Peer Reviewed International Research Journal
Publisher: Global Journals
Online ISSN: 2249-4588 & Print ISSN: 0975-5853

Exploring Effective Factors in the Demographic and Motivation Issues of the Banking Sector of Bangladesh

By Mohammad Azizur Rahman

Begum Rokeya University

Abstract- The paper attempted to explore the most effective factors of demographic outlined affecting employees' motivation. With a view to empirical analysis data were collected from 400 bank employees. In the demographic issues gender, age, experience, pay, type and name of the bank, present and prior designations etc. were considered. For inferential statistics there were five regression models with ANOVA and coefficients models developed in the study. The dependent variables were namely work experience, present basic and gross salary, and initial basic and gross salary and 94%, 77%, 68%, 48% and 35% respectively explained by other independent predictors. The study found that work experience was strongly affected by age. On the other hand, present pay (basic and gross) was highly subjective by present designation and initial basic and gross salaries were prejudiced by initial or first joining designation of the employees. The study was also observed on findings that age, present and first joining designations modify employees' motivation in the banking sector of Bangladesh (showed in Table 18).

Keywords: age, gender, work experience, initial salary, gross salary, motivation.

GJMBR-A Classification: JEL Code: M12



Strictly as per the compliance and regulations of:



© 2020, Mohammad Azizur Rahman. This is a research/review paper, distributed under the terms of the Creative Commons Attribution-Noncommercial 3.0 Unported License <http://creativecommons.org/licenses/by-nc/3.0/>), permitting all non-commercial use, distribution, and reproduction in any medium, provided the original work is properly cited.

Exploring Effective Factors in the Demographic and Motivation Issues of the Banking Sector of Bangladesh

Mohammad Azizur Rahman

Abstract- The paper attempted to explore the most effective factors of demographic outlined affecting employees' motivation. With a view to empirical analysis data were collected from 400 bank employees. In the demographic issues gender, age, experience, pay, type and name of the bank, present and prior designations etc. were considered. For inferential statistics there were five regression models with ANOVA and coefficients models developed in the study. The dependent variables were namely work experience, present basic and gross salary, and initial basic and gross salary and 94%, 77%, 68%, 48% and 35% respectively explained by other independent predictors. The study found that work experience was strongly affected by age. On the other hand, present pay (basic and gross) was highly subjective by present designation and initial basic and gross salaries were prejudiced by initial or first joining designation of the employees. The study was also observed on findings that age, present and first joining designations modify employees' motivation in the banking sector of Bangladesh (showed in Table 18).

Keywords: age, gender, work experience, initial salary, gross salary, motivation.

1. INTRODUCTION AND REVIEW CONTEXT

Human Resource Management (HRM) is regarded as the significant department for talent management. The talented employees compulsorily considered as assets in the organization which can be effective through acquisition, development, motivation and maintenance integrated from all units of the bank. HRD selects the right kind of personnel for the committed posts. In addition to this, HRD maintains talent human resources for the bank by applying various motivational techniques and HRs considered as soft assets (www.ventureline.com). Since bank is a service industry, this is why, its sustainability and competitive opportunities depends on how HR Department utilize their potentialities and competencies. The need of talent employees is well recognized in all events of global financial crisis (2007-2008) that was mostly connected with ambitious and ineffectual investment decision by the banks (Islam et al, 2017). Bangladesh Bank (BB) and Ministry of Finance (MoF) emphasized to ensure better HRM in the banking sector of Bangladesh through circulars (BB & MoF, 2015). The

Author: PhD Student, IBS, RU & Associate Professor, Management Studies Begum Rokeya University, Rangpur, Bangladesh.
e-mail: azizur07@gmail.com

circulars are associated with rules and regulations, maintaining banking hours, salaries and incentives, leave and performance appraisal of female employees.

Motivation means inspiring people to work continuation. Motivated employees do have best quality of performance. Employees' motivation is affected by various factors. The total environment of the banking industry has become changed due to face the competitive sustainability. Basic pay, gross pay, designation, promotion, scoring of banking diploma for promotion, experiences, location or posting, types of bank etc. are the issues of demographic factors. Designation and gross pay are highly correlated for motivation.

Different emerging theories of motivation support that age, experience, pay, designation etc. affect the motivation. Work experience relates the holding position through up gradation in the organization. Maslow's need hierarchy theory proves the said issues of demographic (Maslow, 1954). On the other supportive part of the Two-Factor Model namely Hygiene and Motivating factors. Employees can enjoy these factors related to opportunities over a long-term service the organization (Herzberg, 1959, 1987). The Two Factor Theory states that human needs are ordered in a series of levels of the hierarchy accordance to importance which creates motivation. Alderfer's (1969) ERG theory chains Need-Hierarchy and Two-Factor Theory of motivation. Existence (E) chains the basic need and job security, relatedness (R) actually related to social needs and growth (G) is supportive with status and highest level achievement. If a higher order need constants or unfulfilled, an individual can degenerate to lower order needs which cause satisfy easily. Mc Clelland's Three Needs Model (1961) is also supportive to Needs Theory of Maslow whereas it can be seen that need for affiliation (social need), need for power related to ego/status and remaining one that is need for achievement connected to challenging achievement. An employer does have the ability to understand the needs so as to meet these needs having a better chance of involving and retaining talent employees. A survey conducted by Watson Wyatt Worldwide showed that 71% people deliberate money as the main reason to stay as followed by promotion prospect (33%) (Endress, 2007). Abraham Harold Maslow suggested a theory that

delineated five hierarchical needs which could also be functional to an organization and its employees' performance (Gordon, 1965). Without one of the lower ones the second need could be achieved or satisfied. Maslow's needs theory is static imperative and applicable in today's business organizations, for every organization that seek to obtain success and excellence reflects positively the organizational culture, HRM and the employee's productivity, to attain organizational excellence and create good environment, better and enjoyable work environment and achieve goal at the right time then a effort and application of the theory is supreme (Jerome, 2013). When an organization tries to know what drives personnel to work more, it is in a better position to influence them to perform well (Kovach, 1987). Again it clarifies that employees performance can be examined by three indicators namely ability, workplace environment, and motivation (Griffin, 1990). It is critical job for the managers in terms of motivating subordinates since it is noticed that there globally changes in demographic factors, as well as highly advanced technology (Wiley, 1997). This only emphasized the need to explore what motivates employees in order to get better performance. The author highlighted the most and less important factors of motivation in workplace from the earlier management. The most important factors in 1946 (appreciation), 1980

(interesting work), 1986 (interesting work) and 1992 (good wages) and less important factors were in 1946 (discipline), 1980 (discipline), 1986 (personal problems), and 1992 (personal problems). The study received the most striking findings that money and job security are the clear indicators of motivation. The effective pay program, a primary motivating factor is critical due to individuals and psychological possessions. It is does have immaterial value of the reward, but the increase in self-regard that public recognition accompanying with monetary compensation affords (Dawson and Dawson, 1990). In the past, huge numbers of research studies on employee motivation in the different perspectives already conducted. Very few of them were conducted relating to demographic composition with motivation. The present paper stressed to observe the influential factors of motivation with the sources variables of demographic issues among the employees in the sampled banks. The study also designed to explore the most effective factors in motivation.

Research questions: Does demographic composition affect employee motivation in the banking sector?

Objective of the study: The main objective of the study was to scan effective factors in demographic and motivating focuses among the employees of the banking sector in Bangladesh.

II. RESEARCH FRAMEWORK

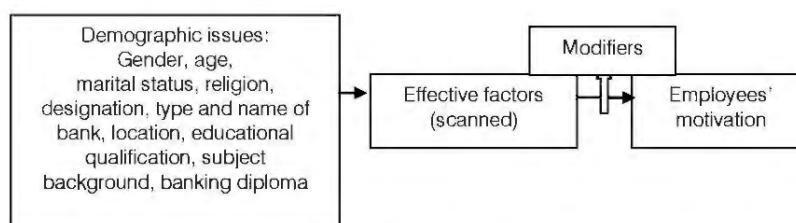

Hypotheses

Alternative hypotheses (H_{a1})

- H_{a1} Employee motivation is related to work experience in the sampled banks.
- H_{a2} There is a positive relationship between employee motivation and present basic salary
- H_{a3} Present gross salary affects employee motivation in the banking sector.
- H_{a4} Initial basic salary motivates employees positively.
- H_{a5} Initial gross salary motivates employee positively.

March-June 2019 from 400 employees (320 employees of four public and remaining 80 employees of six private banks operated in the Northern three districts of Rangpur Division Bangladesh through sample random sampling (SRS). Data have been analyzed by SPSS IBM Version 22.0. Secondary data were collected from different research articles, published and unpublished books, dailies and websites.

III. METHODOLOGY

The study has been designed based on empirical and quantitative materials. The employees who were in the service full time in the banks considered as participants. The primary data were collected during

IV. RESULTS AND DISCUSSION

Table 1: Demographic outline of the respondents (source: Field survey, up to June 2019)

Demographic issues		Percent	Mean	SD	CV
Sex	Male	83.5	1.165	0.372	31.93%
	Female	16.5			
Age group	<30-40 years	59.5	2.633	0.922	35%
	41-50 years	13.8			
	>50 years	26.8			
Marital status	Married	99.0	1.010	0.100	9.86%
	Single	1.0			
Religion	Islam	89.3	1.110	0.321	18.94%
	Hindu	10.75			
Type of bank	Public	80.0	1.200	0.401	33.38%
	Private	20.0			
Location (District)	Rangpur	41.5	1.743	0.712	40.88%
	Dinajpur	42.8			
	Nilphamari	15.8			
Educational Qualification	Bachelor	17	2.660	0.749	28.15%
	Master	83			
Discipline/ Group	Science	31.8	1.865	0.695	37.26%
	Humanities	50			
	Business	18.3			
Bank Diploma	Nil	62.3	0.543	0.761	140.34%
	Part-1	21.3			
	Part-2	16.5			
Job Experience (Year)	1-5	11.3	2.985	1.483	49.70%
	6-10 Years	45.5			
	11-15 Years	8.0			
	16-20 Years	4.0			
	20 Years (more)	31.3			
Present Designation/ Post	Entry Level Officer	77.4	5.505	1.319	23.96%
	Executive Level Officer	22.9			
Present Basic Pay (Tk.)	<10000- 300000/-	49.0	35512	14246	40.12%
	30000/- (more)	511.0			
Present Gross Pay (Tk.)	<20000-40000/-	19.0	60945	26809	44%
	>40000-60000/-	38.0			
	60000/- (more)	43.0			
First Joining Designation	Entry Level Officer	99.5	4.110	1.925	46.85%
	Executive Level Officer	0.5			
Initial Basic Pay (Tk.)	<10000-20000/-	96.6	35512	1424 6	40.12%
	>20000-30000/-	3.5			
Initial Gross Pay (Tk.)	<20000-40000/-	98.8	13401	16433	122.63%
	40000-60000/- (more)	1.2			

Regression Models (Table 2, 5, 8, 11, & 14)

Table 2: Regression: Model Summary^b

Model	R	R Square	Adjusted R Square	Std. Err. of Estimates	Change Statistics				
					R ² Change	F	df1	df2	Sig. F
1	0.971 ^a	0.942	0.940	2.741	0.94	483.94	13	386	0.000

a. Predictors: (Constant), Banking Diploma, Group/ Subject, Gender, Religion, Educational Qualification, Marital Status, Location (District), Type of Bank, Present Designation, First joining designation/post, Name of the Bank, Age, Location (Upazilla).
 b. Dependent Variable: Working experience (year).

Remarks: The fitted linear regression model for working experience (year) and other independent variables listed. The model is good fit for this dataset and the coefficient of multiple determinations R^2 is 0.942 (Table

2). Since the $R^2 \sim 0.94$ then the dependent variable *work experience* 94% explained by the independent variables/predictors.

Table 3: ANOVA^a

	Model	Sum of Squares	df	Mean Square	F	Sig.
1	Regression	47261.760	13	3635.520	483.944	0.000 ^b
	Residual	2899.737	386	7.512		
	Total	50161.498	399			

a. Dependent Variable: Working experience (year)
 b. Predictors: (Constant), Banking Diploma, Group/ Subject, Gender, Religion, Educational Qualification, Marital Status, Location (District), Type of Bank, Present Designation, First joining designation/post, Name of the Bank, Age, Location (Upazilla).

Hypothesis: The null hypothesis, $H_0: B_0 = B_1 = B_2 = \dots = B_{13} = 0$

The alternative hypothesis, $H_1: B_0 = B_1 = B_2 = \dots = B_{13} \neq 0$

Remarks: From the Table 3 ANOVA table the fitted regression model F-test statistic value is 483.944 and the significance value (p value) 0.000 which is less than 0.05 ($p \text{ value} < \alpha$). Then all the regression coefficients

were statistically highly significant at 5% level of significance. That is the null hypothesis is rejected and alternative hypothesis is accepted. Therefore, all the regression coefficients were not zero (0).

Table 4: Coefficients^a

Model	Unstandardized Coefficients		Standardized Coefficients	t	Sig.
	B	Std. Error	Beta		
(Constant: Experience)	-16.110 (B_0)	2.519		-6.395	0.000
Gender	0.664 (B_1)	0.402	0.022	1.652	0.099
Age	0.800 (B_2)	0.034	0.663	23.649	0.000
Marital status	0.697 (B_3)	1.417	0.006	0.492	0.623
Religion	-0.535 (B_4)	0.439	-0.015	-1.220	0.223
Present designation	1.294 (B_5)	0.181	0.152	7.150	0.000
First joining post	-1.663 (B_6)	0.147	-0.286	-11.334	0.000
Type of Bank	-0.567 (B_7)	0.636	-0.020	-0.891	0.374
Name of the Bank	-0.192 (B_8)	0.113	-0.039	-1.697	0.091
Location (District)	0.341 (B_9)	0.665	0.020	0.512	0.609
Location (Upazilla)	-0.055 (B_{10})	0.098	-0.023	-0.555	0.579
Educational qualif.	-0.860 (B_{11})	0.257	-0.057	-3.343	0.001
Group/ Subject	0.001 (B_{12})	0.206	0.000	0.005	0.996
Banking Diploma	0.013 (B_{13})	0.223	0.001	0.059	0.953

a. Dependent Variable: Working experience (year).

The fitted regression model can be defined as,

Workingexperience(year)

$$= -16.110 * (Constant) + 0.664 * Gender + 0.800 * Age + 0.697 * MaritalStatus - 0.535 * Religion + 1.294 * Presentdesignation - 1.663 * Firstjoiningdesignation - 0.567 * TypeofBank - 0.192 * NameoftheBank + 0.341 * Location(District) - 0.055 * Location(Upazilla) - 0.860 * Educationalqualification + 0.001 * GrouporSubject + 0.013 * BankingDiploma$$

Remarks: From the fitted (Table 4) the age, present designation, first joining designation, educational qualification were statistically significance at 5% level of significance. Therefore, employees' motivation is exaggerated by the control variable namely age, designation, and educational qualification. The subject

or major discipline does not directly affect motivation (β_{12}) = 0.001 and p value is 0.996. Among the significant independent predictors age (0.800) and present designation (1.294) were positive contribution on the dependent variable *working experience (year)*.

EXPLORING EFFECTIVE FACTORS IN THE DEMOGRAPHIC AND MOTIVATION ISSUES OF THE BANKING SECTOR OF BANGLADESH

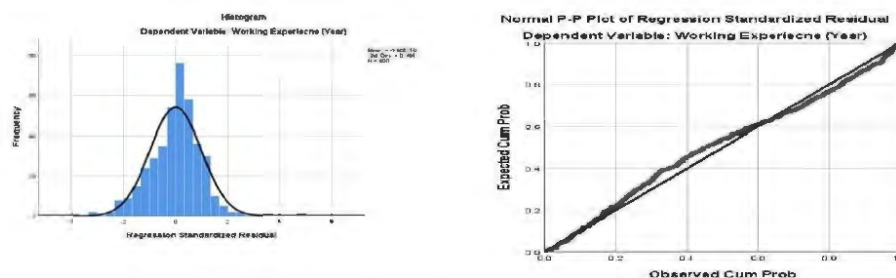

Figure 1 & 2: Histogram and P-P Plot of Regression Standardized Residual (Experience)

Remarks: The Figure 1 & 2 depict that the fitted histogram showed the bell shape curve and Q-Q (quantile-quantile) plot the fitted residual line passing through the origin. Therefore, the dependent variable *working experience (year)* is normally distributed and the linear regression model best fit for this dataset.

Table 5: Regression-Model Summary^b

Model	R	R ²	Adjusted R ²	Std. Err. of the Estimates	Change Statistics				
					R ²	F change	df1	df2	Sig. F
1	0.877 ^a	0.769	0.762	6987.86	0.769	99.1	13	386	0.000

a. Predictors: (Constant), Banking Diploma, Group/ Subject, Gender, Religion, Educational Qualification, Marital Status, Location (District), Type of Bank, Present Designation, First joining designation/post, Name of the Bank, Age, Location (Upazilla).
 a. Dependent Variable: Present Basic Salary.

Remarks: The above fitted linear regression model (Table 5) for *present basic salary* and other independent variables listed. The model is good fit for this dataset and the coefficient of multiple determinations R² is 0.769. Since the R² ~ 0.769 then the dependent variable *present basic salary* 76.9% or about 77% explained by the independent variables/predictors mentioned above.

Table 6: ANOVA^a

Model	Sum of Squares	df	Mean Square	F	Sig.	
1	Regression	62872948092.258	13	4836380622.481	99.045	0.000 ^b
	Residual	18848472031.68	386	48830238.424		
	Total	81721420123.94	399			

a. Dependent Variable: Present Basic Salary
 b. Predictors: (Constant), Banking Diploma, Group/ Subject, Gender, Religion, Educational Qualification, Marital Status, Location (District), Type of Bank, Present Designation, First joining designation/post, Name of the Bank, Age, Location (Upazilla).

Hypothesis: The null hypothesis, H₀: B₀ = B₁ = B₂ = = B₁₃ = 0
 The alternative hypothesis, H₁: B₀ = B₁ = B₂ = = B₁₃ ≠ 0

Remarks: From the (Table 6) ANOVA (Analysis of Variance) table the fitted regression model F-test statistic value is 99.045 and the significance value (p value) 0.000. Then all the regression coefficients were statistically strongly significant at 5% level of significance. That is alternative hypothesis is accepted. Therefore, all the regression coefficients were not zero (0).

Table 7: Coefficients^a

Model	Unstandardized Coefficients			Standardized Coefficients	t	Sig.
	B	Std. Error	Beta			
1	(Cons: Present basic pay)	-38670.051 (B ₀)	6422.814		-6.021	0.000
	Gender	554.461 (B ₁)	1024.262	0.014	0.541	0.589
	Age	709.891 (B ₂)	86.209	0.461	8.235	0.000

EXPLORING EFFECTIVE FACTORS IN THE DEMOGRAPHIC AND MOTIVATION ISSUES OF THE BANKING SECTOR OF BANGLADESH

Marital Status	-5124.611 (B ₉)	3613.823	-0.036	-1.418	0.157
Religion	1360.314 (B ₈)	1118.681	0.031	1.216	0.225
Present designation	6201.641 (B ₇)	461.322	0.571	13.443	0.000
First joining post	1902.867 (B ₆)	374.125	0.256	5.086	0.000
Type of Bank	1834.212 (B ₅)	1621.950	0.051	1.131	0.259
Name of the Bank	282.551 (B ₄)	289.017	0.045	0.978	0.329
Location (District)	-1672.287 (B ₃)	1695.606	-0.078	-0.986	0.325
Location (Upazilla)	74.986 (B ₁₀)	250.856	0.024	0.299	0.765
Educational qualifi.	1623.504 (B ₁₁)	656.077	0.085	2.475	0.014
Group/ Subject	-323.377 (B ₁₂)	525.967	-0.016	-0.615	0.539
Banking Diploma	878.569 (B ₁₃)	569.666	0.047	1.542	0.124

a. Dependent Variable: Present Basic Salary (B₀)

The fitted regression model can be defined as, Model:

Present Basic Salary =

$$-38670.051 * (Constant) + 554.461 * Gender + 709.891 * Age - 5124.611 * MaritalStatus + 1360.314 * Religion + 6201.641 * Presentdesignation + 1902.867 * Firstjoiningdesignation + 1834.212 * TypeofBank + 282.551 * NameoftheBank - 1672.287 * Location(District) + 74.986 * Location(Upazilla) + 1623.504 * Educationalqualification - 323.377 * GroupSubject + 878.569 * BankingDiploma$$

Remarks: From the fitted (Table 7) the age, present designation, first joins designation, educational qualification were statistically significance at 5% level of significance. Among the significant independent

predictors age (709.891), present designation (6201.641) and first joining designation/post (1902.867) were positive contribution to the dependent variable present basic salary.

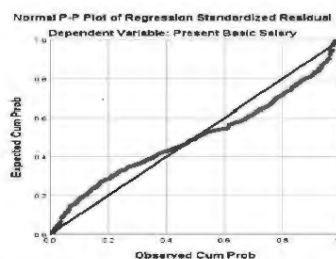
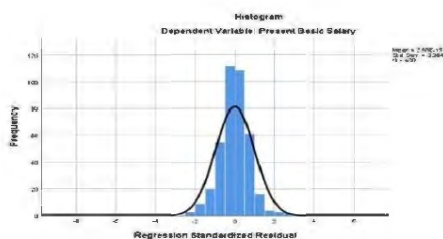

Figure 3 & 4: Histogram and P-P Plot of Regression Standardized Residual (Present basic salary)

Remarks: From the fitted histogram (Figure 3 & 4) showed the bell shape curve and Q-Q (quantile-quantile) plot the fitted residual line passing through the

origin. Therefore, the dependent variable Present Basic Salary is normally distributed and the linear regression model best fit for this dataset.

Table 8: Regression-Model Summary^b

Model	R	R ²	Adjusted R ²	Std. Err. of the Estimates	Change Statistics				
					R ²	F change	df1	df2	Sig. F
1	0.826 ^a	0.682	0.672	15365.25	0.682	63.742	13	386	0.000

a. Predictors: (Constant), Banking Diploma, Group/ Subject, Gender, Religion, Educational Qualification, Marital Status, Location (District), Type of Bank, Present Designation, First joining designation/post, Name of the Bank, Age, Location (Upazilla)

b. Dependent Variable: Present gross salary

Remarks: The fitted linear regression model (Table 8) for Present Gross Salary and other independent variables listed above. The model is good fit for this dataset and the coefficient of multiple determinations R² is 0.682.

Since the R² ~ 0.682 then the dependent variable present gross salary 68.2% explained by the independent variables/predictors.

Table 9: ANOVA^a

Model	Sum of Squares	df	Mean Square	F	Sig.	
1	Regression	195635872639.298	13	15048913279.950	63.742	0.000 ^b
	Residual	91131097360.703	386	236090925.805		
	Total	286766970000.000	399			

a. Dependent Variable: Present gross salary
 b. Predictors: (Constant), Banking Diploma, Group/ Subject, Gender, Religion, Educational Qualification, Marital Status, Location (District), Type of Bank, Present Designation, First joining designation/post, Name of the Bank, Age, Location (Upazilla)

Hypothesis: The null hypothesis, H0: B₀ = B₁ = B₂ = = B₁₃ = 0

The alternative hypothesis, H1: B₀ = B₁ = B₂ = = B₁₃ ≠ 0

Remarks: From the (Table 9) ANOVA (Analysis of Variance) table the fitted regression model F-test statistic value is 63.742 and the significance value (p value) 0.000. Then all the regression coefficients were statistically highly significant at 5% level of significance. That is, alternative hypothesis is accepted. Therefore, all the regression coefficients were not zero (0).

Table 10: Coefficients^a

Model		Unstandardized Coefficients		Standardized Coefficients	t	Sig.
		B	Std. Error	Beta		
1	(Constant: Present gross)	-76402.124	14122.791		-5.410	0.000
	Gender	1172.807	2252.196	0.016	0.521	0.603
	Age	1244.412	189.561	0.432	6.565	0.000
	Marital Status	-9286.091	7946.247	-0.035	-1.169	0.243
	Religion	1028.259	2459.809	0.012	0.418	0.676
	Present designation	10226.033	1014.378	0.503	10.081	0.000
	First joining design.	3129.422	822.645	0.225	3.804	0.000
	Type of Bank	15523.420	3566.423	0.232	4.353	0.000
	Name of the Bank	420.502	635.505	0.036	0.662	0.509
	Location (District)	-4565.112	3728.379	-0.113	-1.224	0.222
	Location (Upazilla)	326.900	551.594	0.057	0.593	0.554
	Educational qualification	2791.159	1442.615	0.078	1.935	0.054
	Group/ Subject	-282.423	1156.521	-0.007	-0.244	0.807
	Banking Diploma	1700.733	1252.610	0.048	1.358	0.175

a. Dependent Variable: Present gross salary

The fitted regression model can be defined as,

Present Gross Salary

$$= -76402.124 * (Constant) + 1172.807 * Gender + 1244.412 * Age - 9286.091 * MaritalStatus + 1028.259 * Religion + 10226.033 * PresentDesignation + 3129.422 * Firstjoiningdesignation + 15523.420 * TypeofBank + 420.502 * NameoftheBank - 4565.112 * Location(District) + 326.900 * Location(Upazilla) + 2791.159 * EducationalQualification - 282.423 * GrouporSubject + 1700.733 * BankingDiploma$$

Remarks: From the (Table 10) fitted the age, present designation, first joins designation, educational qualification were statistically significance at 5% level of significance. Among the significant independent predictors age (1244.412), present designation (10226.033), first joining designation/post (3129.422) and type of bank (15523.420) were positive contribution to the dependent variable Present Gross Salary. Therefore, there is a strong association among age, present designation, joining post and type of bank that affect employee satisfaction.

EXPLORING EFFECTIVE FACTORS IN THE DEMOGRAPHIC AND MOTIVATION ISSUES OF THE BANKING SECTOR OF BANGLADESH

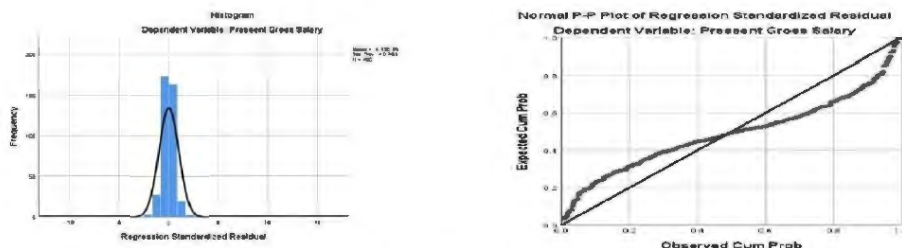

Figure 5 & 6: Histogram and P-P Plot of Regression Standardized Residual (Present gross salary)

Remarks: From the fitted histogram (Figure 5 & 6) origin. Therefore, the dependent variable *Present Gross Salary* is normally distributed and the linear regression model best fit for this dataset.

Table 11: Regression-Model Summary^b

Model	R	R ²	Adjusted R ²	Std. Err. of the Estimates	Change Statistics				
					R ²	F change	df1	df2	Sig. F
1	0.689 ^a	0.475	0.457	5713.00316	0.475	26.857	13	386	0.000
a. Predictors: (Constant), Banking Diploma, Group/ Subject, Gender, Religion, Educational Qualification, Marital Status, Location (District), Type of Bank, Present Designation, First joining designation/post, Name of the Bank, Age, Location (Upazilla).									
b. Dependent Variable: Initial basic salary									

Remarks: The fitted linear regression model (Table 11) for *Initial Basic Salary* and other independent variables listed above. The model is fit for this dataset and the coefficient of multiple determinations R² is 0.475. Since the R² ~ 0.475 then the dependent variable *initial basic salary* 47.5% explained by the independent estimators.

Table 12: ANOVA^a

Model	Sum of Squares	df	Mean Square	F	Sig.	
1	Regression	11395615319.173	13	876585793.783	26.857	0.000 ^b
	Residual	12598424380.577	386	32638405.131		
	Total	23994039699.750	399			

a. Dependent Variable: Initial basic salary
 b. Predictors: (Constant), Banking Diploma, Group/ Subject, Gender, Religion, Educational Qualification, Marital Status, Location (District), Type of Bank, Present Designation, First joining designation/post, Name of the Bank, Age, Location (Upazilla)

Hypothesis: The null hypothesis, H0: B₀ = B₁ = B₂ = = B₁₃ = 0

The alternative hypothesis, H1: B₀ = B₁ = B₂ = = B₁₃ ≠ 0

Remarks: From the ANOVA Table 12 the fitted regression model F-test statistic value is 26.857 and the level of significance. That is the null hypothesis is rejected and alternative hypothesis is accepted. Therefore, all the regression coefficients were not zero (0).

Table 13: Coefficients^a

Model	Unstandardized Coefficients		Standardized Coefficients	t	Sig.
	B	Std. Error	Beta		
1	(Constant: Initial Basic Pay)	6234.435	5244.365	1.189	0.235
	Gender	-350.697	838.100	-0.017	0.676
	Age	-121.912	71.022	-0.146	0.087
	Marital Status	1247.972	2977.753	0.016	0.675
	Religion	-21.884	918.839	-0.001	0.981

EXPLORING EFFECTIVE FACTORS IN THE DEMOGRAPHIC AND MOTIVATION ISSUES OF THE BANKING SECTOR OF BANGLADESH

Present Designation	-671.561	378.451	-0.114	-1.775	0.077
First joining designation/post	2220.853	308.118	0.551	7.208	0.000
Type of Bank	-1285.682	1402.737	-0.066	-0.917	0.360
Name of the Bank	1064.391	236.772	0.326	4.495	0.000
Location (District)	1761.002	1401.011	0.162	1.257	0.210
Location (Upazilla)	-280.441	206.022	-0.178	-1.361	0.174
Educational Qualification	-879.276	538.907	-0.085	-1.632	0.104
Group/ Subject	-306.230	431.933	-0.027	-0.709	0.479
Banking Diploma	-199.290	462.560	-0.020	-0.431	0.667

a. Dependent Variable: Initial basic salary

The fitted regression model can be defined as,

Initial basic salary

$$= 6234.435 * (Constant) - 350.679 * Gender - 121.912 * Age + 1247.972 * Marital Status - 21.884 * Religion - 671.561 * Present designation + 2220.583 * First joining designation - 1285.682 * Type of Bank + 1064.391 * Name of the Bank + 1761.002 * Location (District) - 280.441 * Location (Upazilla) - 879.276 * Educational qualification - 306.230 * Group or Subject - 199.290 * Banking Diploma$$

Comment: From the fitted coefficients (Table 13) the first name of the bank were statistically significance at 5% level of significance. Among the significant independent predictors first joining designation/post

(2220.853) and name of bank (1064.391) were positive contribution to the dependent variable Initial Basic Salary.

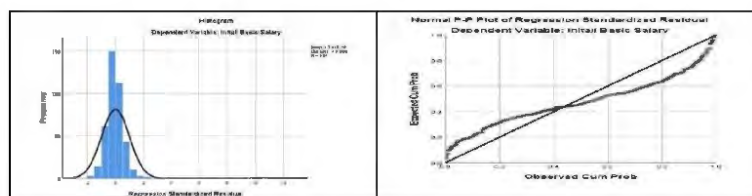

Figure 7 & 8: Histogram and P-P Plot of Regression Standardized Residual (Initial basic salary)

Remarks: From the Figure 7 & 8 depict that the fitted histogram showed the bell shape curve and Q-Q (quantile-quantile) plot the fitted residual line passing

through the origin. Therefore, the dependent variable initial basic salary is normally distributed and the linear regression model best fit for this dataset.

Table 14: Regression-Model Summary^b

Model	R	R ²	Adjusted R ²	Std. Err. of the Estimates	Change Statistics				
					R ²	F change	df1	df2	Sig. F
1	0.592 ^a	0.351	0.329	13459.34450	0.351	16.058	13	386	0.000

a. Predictors: (Constant), Banking Diploma, Group/ Subject, Gender, Religion, Educational Qualification, Marital Status, Location (District), Type of Bank, Present Designation, First joining designation/post, Name of the Bank, Age, Location (Upazilla)
b. Dependent Variable: Initial gross salary

Table 15: ANOVA^a

Model	Sum of Squares	df	Mean Square	F	Sig.	
1	Regression	37815785084.065	13	2908906544.928	16.058	0.000 ^b
	Residual	69925426394.726	386	181153954.390		
	Total	107741211478.791	399			

a. Dependent Variable: Initial gross salary
b. Predictors: (Constant), Banking Diploma, Group/ Subject, Gender, Religion, Educational Qualification, Marital Status, Location (District), Type of Bank, Present Designation, First joining designation/post, Name of the Bank, Age, Location (Upazilla)

Hypothesis: The null hypothesis, H0: B₀= B₁= B₂=.....= B₁₃=0
The alternative hypothesis, H1: B₀= B₁= B₂=.....= B₁₃≠0

Remarks: From the Table 15 (ANOVA) the fitted regression model F-test statistic value is 16.058 and the significance value (p value) 0.000. Then all the regression coefficients were statistically significant at 5% level of significance. That is the null hypothesis is rejected. Therefore, all the regression coefficients were not zero (0).

Table 16: Coefficients^a

Model	Unstandardized Coefficients		Standardized Coefficients	t	Sig.
	B	Std. Error	Beta		
(Constant: Initial Gross Pay)	181.712	12371.000		0.015	0.988
Gender	25.992	1972.834	0.001	0.013	0.989
Age	-90.130	166.047	-0.051	-0.543	0.588
Marital Status	5525.183	6960.595	0.033	0.794	0.428
Religion	-251.863	2154.695	-0.005	-0.117	0.907
Present designation	-1829.536	888.554	-0.147	-2.059	0.040
First joining designation	4425.217	720.604	0.519	6.141	0.000
Type of Bank	-1458.181	3124.043	-0.036	-0.467	0.641
Name of the Bank	2449.083	566.677	0.337	4.399	0.000
Location (District)	2369.895	3265.911	0.096	0.726	0.468
Location (Upazilla)	-360.575	483.174	-0.102	-0.746	0.456
Educational qualification	-1895.923	1263.673	-0.086	-1.500	0.134
Group/ Subject	164.586	1013.066	0.007	0.162	0.871
Banking Diploma	321.652	1097.236	0.015	0.293	0.770

a. Dependent Variable: Initial Gross Salary

From the coefficients Table 16 the study observed that *present designation*, *first joining and name of the bank* were statistically significance at 5% level of significance. Among the significant independent predictors first joining designation/post (4425.217) and name of bank (2449.083) were positively affected the dependent variable *Initial Basic Salary*.

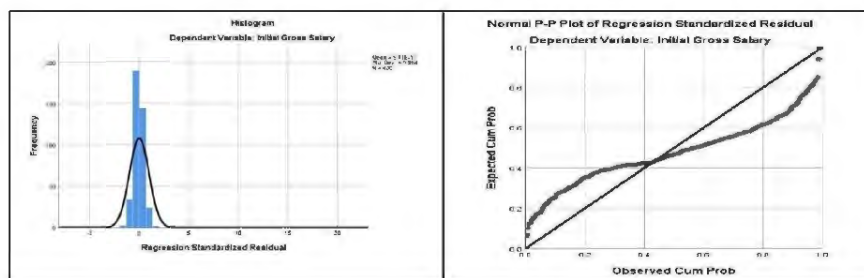

Figure 9 & 10: Histogram and P-P Plot of Regression Standardized Residual (Initial gross pay)

Remarks: From the fitted histogram (Figure 9 & 10) showed the bell shape curve and Q-Q (quantile-quantile) plot the fitted residual line passing through the origin. Therefore, the dependent variable *initial gross salary* is normally distributed and the linear regression model best fit for this dataset.

Table 17: Results of alternative hypotheses (H_a) from ANOVA Table 3,6,9,12, &16

H _a	Results	Remarks	Relationship/ effect on employee motivation
H _{a1}	p<0.05	Sustained	Employee motivation is related to work experience.
H _{a2}	p<0.05	Sustained	There is a relationship between motivation present basic pay.
H _{a3}	p<0.05	Sustained	Present gross salary affects employee motivation.
H _{a4}	p<0.05	Sustained	Initial gross salary motivates employee positively.
H _{a5}	p<0.05	Sustained	Initial basic salary motivates employees positively.

Therefore, employee motivations affected by all the factors of demographic issues in the banks were accordingly observed.

Overall it can be explained that employees are in the service of the banking sector influenced by the age, experience, present designation, joining post, type of bank, present and initial gross. There were strong relationships among these control or sources variables in the study. Gender did not affect the satisfaction of

the bank employees. Among these factors the most effective factors were age and present designation (standardized Beta coefficient value 0.663 and 0.571). On the other hand, banking diploma mostly affects the promotion in case of public bank.

Table 18: Overall findings from the Table 2&4, 5&7, 8&10, 11&13, 14&16, 17

Dependent variable	R ²	Standardized coefficient	Effective factors	Motivation
Work experience	94%	Age (β=0.663), present designation (β = 0.152)	Age	Therefore, motivation is highly associated and modified by demographic effective factors already explored in column 4.
Present basic pay	77%	Present designation (β=0.571), age (β=0.461), and first joining designation (β=0.256)	Present designation	
Present gross pay	68.2%	Present designation (β=0.503), age (β=0.432), type of bank (β=0.232)and first joining designation (β=0.225)	Present designation	
Initial basic pay	47.5%	First joining designation (β=0.551), and Name of the bank (β=0.326)	First joining designation	
Initial gross pay	35.1%	First joining designation (β=0.519), and Name of the bank (β=0.337)	First joining designation	

It is evident from the Table 18 work experience is 94% explained by variance whereas age is strongly associated with job experience. Present basic salary 77% is explained by total predictors and it is highly affected by present designation of the existing employees. Present gross salary 68.2% is varied by the estimators and it is mostly influenced by present position of an employee. Initial basic salary is 47.5% ~48% explained by variance and is prejudiced by first joining designation. Initial gross salary 35.1% is explained by total variance and it is strongly affected by employees' first joining designation. Therefore, employees' motivation of the banking sector of Bangladesh is highly associated with work experience, present and initial salaries which are mostly modified by age, present and initial designation. Finally, equation may be Employee Motivation = f (Age + Present designation + Initial designation).

V. CONCLUDING REMARKS

Motivation is a complex to determine its level. The study found from the empirical analysis based on demographic outlined that the most effective factors age, present designation, first joining designation were explored and strongly associated with employee motivation in the banking sector of Bangladesh. Sample area, job experience and pay were considered only which may confine the scope of the study. Lack of huge context of the research is another limitation in the paper. Further study should emphasize in a larger scale of employee perception concentrating on job security and money or pay intrinsically as well as extrinsically.

ACKNOWLEDGEMENT

The author of this article is grateful to the honorable Professor Dr. Md. Omar Faruk Sarker (PhD Supervisor of the author), Marketing Department, & Dr. Md. Kamruzzaman (PhD Co-Supervisor of the author), Associate Professor (Statistics), IBS, University of Rajshahi, Bangladesh.

REFERENCES RÉFÉRENCES REFERENCIAS

1. Alderfer, C., P. (1969). An empirical test of a new theory of human needs. *Organizational Behavior and Human Performance*, 4 (2): 142-75. doi: 10.1016/003 0-5073(69)90004-X.
2. BRPD Circular Letter No. 07, Dated 17 June 2015.
3. Dawson, K. M. and Dawson, S. N. (1991). The cure for employee malaise-motivation. *Clinical Laboratory Management Review*, Vol. 5 No. 4: 296-98, 300, 302.
4. Endress P. (2007). How to hire and retain top talent, *management corner*: 10-11.
5. Gordon, G. G (1965). The relationship of satisfiers and dissatisfiers to productivity, turnover and morale, *American Psychologist*, Vol. 20: 499-502.
6. Griffin, R. W. (1990), *Management*, 3rd ed., Houghton Mifflin Company, Dallas, TX: 437.
7. Herzberg, F. (1987). Workers' needs: the same around the world. *Industry Week*: 29-30 32.
8. Islam, M., T., Haque, M., M., Yesmin, R., Ismal, M., R., and Islam, M.,M. (2017). Human Resource of Banks. *Banking Review Series*, BIBM, Dhaka: 292.
9. Kovach, K., A. (1987). What motivates employees? Workers and supervisors give different answers. *Business Horizons*, Vol. 30(5): 58-65.

10. Maslow, A. H. (1954). *Motivation and Personality*: NY: Harper.
11. Mc Clelland, D. (1961). *The Achieving Society*, NY: The Free Press.
12. Nyameh Jerome, N. (2013). Application of the Maslow's hierarchy of need theory; impacts and implications on organizational culture, human resource and employee's performance. *International Journal of Business and Management Invention*, Vol. 2 (3): 39-45.
13. Wiley, C. (1997). What motivates employees according to over 40 years motivation surveys. *International Journal of Manpower*, Vol. 18, Issue 3:263-280; <http://dx.do.org/10-1108/01437729710169373>.
14. www.ventureline.com





Research Article

Investigating the Effect of Women's Position on Advancement in the Banking Sector of Bangladesh

Mohammad Azizur Rahman*, Mohammad Rafiul Azam Khan

Department of Management Studies, Begum Rokeya University, Rangpur, Bangladesh

Article Information

Received: 15 September 2020
 Revised version received: 13 October 2020
 Accepted: 16 October 2020
 Published: 29 October 2020

Cite this article as:

M.A. Rahman and M.R.A. Khan (2020) *Int. J. Soc. Sc. Manage.* 7(4): 191-197.
 DOI: 10.3126/ijssm.v7i4.32483

*Corresponding author

Mohammad Azizur Rahman,
 Associate Professor, Management Studies, Begum
 Rokeya University, Rangpur, Bangladesh
 Email: azizn07@gmail.com

Peer reviewed under authority of IJSSM
 © 2020 IJSSM, Permits unrestricted use under the
 CC-BY-NC license.

OPEN ACCESS

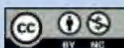

This is an open access article & it is licensed under a
 Creative Commons Attribution Non-Commercial 4.0
 International
 (<https://creativecommons.org/licenses/by-nc/4.0/>)

Keywords: Gender; equity; promotion; women position

Abstract

The paper aimed at investigating the existing status and the impact of giving promotion on women's position in the banking industry. The study was used purposive sampling on 250 employees serving the public, private and specialized banks. Normal frequency distribution as well as inferential statistics (χ^2 -test) was applied to analyze data. For examining the effect of the number of promotion received by employees on gender position they hold chi-square test statistic was used. The study reveals that there was 85% of male and 15% of female employees worked in the banking industry. It was observed that female employees worked 16.7% of state-owned commercial (SOBs), 13.5% of private commercial (PCBs), and 13.08% of specialized (SPBs) banks (shown in Table 5). Consequently, a few numbers of female employees were at the senior level. The entry level female employees were 25% of female observed. The study also found that there was a strong association between the women's position and the number of promotion they up gradated. The study has suggested for managerial as well as policy implications the study suggested for further study to treat equally sustaining in the competitive field of financial institutions.

Introduction and Research Perspectives

In the work place men and women do have a significant role to achieve the sated goals of the organizations. The role of women worldwide is experiencing a dramatic change. Equal employment opportunities conform by the organizations. It has been embargoed that women and men have equal prestige; enjoy the same human rights; play equally valued roles through their appointment in national,

economic, social and cultural development and enjoy the benefits of this equality (Gender Policy, 2014). United Nations (UN) declared that there should have the equal compensation for a job done women (UNDP 1993). In the Constitution of Bangladesh included in the Article Section 29 (1 & 2), and adopted the equal opportunities in respect to the public service organizations (Constitution, 1972). GO

Full text of this paper can be downloaded online at www.ijssm.org/ & <http://nepjol.info/index.php/IJSSM/issue/archive> 191

and NGO have been recruiting for a long from the launching their firms and equally treated. According to Global Gender Report (2010) 30% of women are holding the corporate positions. Attractive remunerative packages fascinated female in the corporate service. It has been observing that women are now involved in the service of the banking sector, telecom industries, airlines professionals, physician, journalism etc. Bangladesh is not an excluded. In the banking sector Bangladesh, many women are serving the public and private banks and reaching the top position. A study was conducted whether women employ in the managerial positions and presenting the women at senior managerial roles and suggested to include gender studies as discourses and practices (Anne and Kate, 2010). Another study, authors examined whether women employ gender capital in the management field and proposed the different ways in the presence of women in the senior managerial roles could shape contemporary management discourses and practices (Kamal and Amina, 2014). Another study (Afza and Newaz, 2008) examined the existence of glass ceiling in different industries and service sectors in Bangladesh. There are two questions raised regarding women: what are the formal and informal requirements for advancement women in the government services of Bangladesh? Do any of these requirements place women as disadvantage situation with respect to career advancement? The authors that women representation in civil service is in increasing trend but at the higher-level positions presence of women is far low, which is indicative of the existence of certain barriers to the advancement of women (Kabir *et al.*, 2016; Kabir, 2014). In corporate women's position is just like a pyramid. Here huge portion of women are recruited at the entry level but few of them to reach the top. For instance, the Bangladesh Bank data showed that only one bank has so far set up childcare unit but other banks are ignoring it. Besides, 25 banks had not arranged any transport facilities for female staffs and only 9 banks initiated arranging awareness training on gender issue (Uddin, 2013). It has been observed by the studies and reports that the employment rate in the banking sector of Bangladesh declined to 12.23% in 2018 from 13.73% in the earlier year 2018 (Mehedi and Sunon, 2017). The ratio of female executives reaching higher positions shows a negligible figure found by BIBM study (www.dailyasianage.com/April 2017). Central Bank of Bangladesh (BB) officials stated that the women employees have not been by the new launched banks in the country (BB Official, 2017). Studies were conducted based on different issues of women and their status, socio-economic scenario. The main aim of the present study is to investigate the women's position in the banking industry (public and private) of Bangladesh. The study purposively selected the Rangpur City as survey area.

Research Questions

1. What are the present positions of women in the public and private banks?
2. What are drawbacks of women occupying the managerial positions in the banking sector?

Objectives of the Study

The main goal of the study is to investigate the present position of the female employees in the banking sector. The specific objectives are set as:

- To highlight the present position of male and female employees in the study, and
- To justify the gender position with receiving number of promotions for advancement.

Data and Methods

The study has been conducted on the basis of primary and secondary sources. There are around 1190 employees are serving the different banks in the study area. Primary data are collected through Likert's Five Point Scale (Agree (A)=1, Strongly Agree (SA)= 2, Disagree (D)= 3, Strongly Disagree (SD)=4, and Neutral (N)= 5. A purposive sampling was used to gathering information from 185 male and 65 female employees (N=250) out of 65 branches of 41 different banks operating in Rangpur City. Questionnaire developed for examining the number in case of gender position in the respective banks. The χ^2 -test was used to test hypothesis. Secondary data are collected from the different journals, articles, publications, dailies, bank websites etc. to analysis the earlier literature. Survey was conducted in 2018 at Rangpur City, Bangladesh.

Hypothesis: H_0 : There is an effect of promotion on women's position in the banks.

Results and Discussion

It is evident that there is no bias for upgrading the male and female employees. The banking institutions are to follow the general qualifications, experiences, efficiency of the employees while taking promotional decision respective positions (Table 1). Female employees recognize that they have been treated equally regarding the gender bias. Banks consider female employees are the vital part as the corporate citizenship globally. Most of the male employees mean that they are treated equally without bias.

The Table 2 shows that total 557 employees work in the state-owned commercial banks whereas 464 (83.30%) of male and 85 (16.70%) of female as percentage. Elaborately 557 employees were in the service of 8 branches of Sonali Bank Limited, 4 branches of Janata Bank Limited, 5 branches of Agrani Bank Limited, 4 branches of Rupali Bank Limited, 1 branch of BASIC Bank Limited, and 1 branch of BDBL is operating in Rangpur City.

Table 1: Demographic Composition (N=250). Field Survey

Demographic profile	Male (%)	Female (%)	Observations on 1st column	
(1.a) Age group (year) Ratio: M=185; F=65	25-30	50 (27.03%)	It is being observed that male employees 185 (74%) are more than the female 65 (26%). The average age of male and female employees is 33.45 years and 32.92 years respectively which is more than the female employees (1.a).	
	31-35	59 (31.90%)		
	36-40	34 (18.38%)		
	40-45	12 (6.48%)		
	45- 50	10 (5.41%)		
	50-55	10 (5.41%)		
	55-60	10 (5.41%)		
Average age	Years	33.45	32.92	
(1.b) Edu. qualification	Bachelor	46 (24.87%)	Bachelor and master degree ratio are about .25:75, and .40:.60 (1.b).	
	Master	139 (75.13%)		39 (60%)
(1.c) Job experience (year)	1-5	89 (48.10%)	Serving with obtaining experience between 1- 5 years of the female employees is greater than the male but in remaining other cases it is exceptional that means greater than female employees (1.c).	
	6-10	44 (23.78%)		8 (12.31%)
	11-15	13 (7.02%)		6 (9.32%)
	16-20	8 (4.32%)		0
	21-25	8 (4.32%)		0
	26-30	10 (5.40%)		5 (7.70%)
	31-35	11 (5.95%)		6 (9.23%)
(1.d) Number of promotions received	Nil	93 (50.28%)	Both male and female employees received promotion with equal basis. That means it is being found that there is no difference between male and female employees regarding promotion and advancement (1.d).	
	One	38 (20.54%)		11 (16.92%)
	Two	22 (11.89%)		8 (12.31%)
	Three	25 (13.51%)		4 (6.15%)
	Four	3 (1.62%)		1 (1.54%)
	Five	2 (1.08%)		2 (3.08%)
	Six	2 (1.08%)		1 (1.54%)
(1.e) Obstacles to advancement (perception)	Agree	10 (5.41%)	Female employees are recruited at the first line level. Both of them are disagreed regarding static barrier to women at advancement (1.e).	
	SA	0		0
	Disagree	64 (34.59%)		21 (32.31%)
	SD	111 (60.0%)		40 (61.54%)
	Neutral	0		0

Source: Compiled from field survey 2018.

Table 2: Employee of different State -owned Commercial Banks (SOBs) in Rangpur City

Name of the bank (branch)	Male	Female	Total
1. Sonali Bank Limited, (8)	235 (80.48%)	57 (19.52%)	292
2. Janata Bank Limited, (4)	71 (85.54%)	12 (14.46%)	83
3. Agrani Bank Ltd., (5)	80 (85.10%)	14 (14.90%)	94
4. Rupali Bank Ltd., (4)	48 (87.27%)	6 (12.73%)	54
5. BASIC Bank (1)	19 (86.36%)	03 (13.64%)	22
6. BDBL, (1)	11 (91.67%)	1 (8.33%)	12
Total = SL ₁ - SL ₆ (23 branches)	464 (83.30%)	93 (16.70%)	557

Table 3 shows that 526 employees have been in the service of 31 private commercial banks including one co-operative bank limited at 34 branches whereas 455 (86.50%) of male and 71 (13.50%) of female.

From Table 4 it is being observed that total number employees are in the service of the specialized bank at the study area whereas 86.92% of male and 13.08% of female.

Table 5 confirmations that 41 different Banks at 65 branches of the respective Bank of which 80.48% male and 19.52% female employees are working in the state-owned commercial banks and its 23 branches, and 86.5% of male and 13.5% of female employees are in the service at private commercial banks and its 35 branches, and remaining 86.92% of male and 13.08% of female employees have been serving at 7 the specialized banks of the study area.

Table 3: Employees in Private Commercial Banks (PCBs) in Rangpur City (Total=526)

Banks (br.)	Male	Female	Banks	Male	Female
1. PBL (3)	30 (66.67%)	15 (33.33%)	17. AAIBL	7 (77.78%)	2 (22.22%)
2. UBL (2)	24 (80.71%)	4 (14.29%)	18. Premier	8 (80%)	2 (20%)
3. SIBL	13 (92.86%)	1 (7.14%)	19. SIBL	18 (94.74%)	1 (5.26%)
4. UCBL	11 (84.62%)	2 (15.38%)	20. ONE	10 (91.9%)	1 (8.1%)
5. NCC	11 (84.62%)	2 (15.38%)	21. Jamuna	15 (78.95%)	4 (21.05%)
6. MTBL	10 (91.91%)	1 (9.1%)	22.SBACBL	9 (100%)	0 (0.0%)
7. DBL	9 (90%)	1 (10%)	23. Southeast	12 (92.31%)	1 (7.69%)
8. PRIME	11 (91.67%)	1 (8.33%)	24. Trust	10 (100%)	0 (0%)
9. EXIM	12 (80%)	3 (20%)	25. BRAC	12 (80%)	3 (20%)
10. IFIC	9 (75%)	3 (25%)	26.AB Bank	9 (75%)	3 (25%)
11. IBBL (2)	87 (90.62%)	9 (9.38%)	27. The City	9 (81.82%)	2 (18.18%)
12. NBL	19 (95%)	1 (5%)	28. Standard	13 (100%)	0 (0%)
13. Bank Asia	7 (100%)	0 (0.0%)	29. DMC	20 (95.24%)	1 (4.76%)
14. NRBC	5 (83.33%)	1 (16.67%)	30. FSIBL	09 (90.91%)	2 (90.91%)
15. MBL	13 (92.86%)	1 (7.14%)	31. DBBL	14 (87.5%)	2 (12.5%)
16. Eastern	10 (90.91%)	1 (9.09%)	Total	455 (86.5%)	71 (13.5%)

Source: Field Survey 2018.

Table 4: Employees in Specialized Banks (SPBs), Rangpur City

Name of Bank	Male	Female	Total
1. RAKUB (4 branches)	45 (83.33%)	09 (16.67%)	54
2. Karmasangsthan Bank	06 (85.71%)	01 (14.29%)	07
3. Prabasi Kallan Bank	04 (80%)	01 (20%)	05
4. Grameen Bank	38 (92.68%)	03 (7.32%)	41
Total = (1+2+3+4)	93 (86.92%)	14 (13.08%)	107

Source: Field Survey 2018.

Table 5: Overall distribution of total employees of 3 categories banks in Rangpur City

Name of the Bank	Total	Male	Female	Female
SOBs (23 branches)	06	557 (46.8%)	464 (80.48%)	93 (19.52%)
PCBs (35 branches)	31	526 (44.2%)	455 (86.5%)	71 (13.50%)
SPBs (7 branches)	04	107 (8.99%)	93 (86.92%)	14 (13.08%)
Employees of 65 branches	41	1190 (100%)	1012 (85%)	178 (15%)

Source: Field Survey 2018.

Table 6 shows that female employees are less than the male employees serving the banking sector at the study field. Female employees are holding the 25% of female at entry level, which is the maximum number. Holding the position at upper levels by the female employees such as AAVP, AGM, DGM, GM etc. are not found due to fewer number with compared to the male employees.

Analysis of hypothesis

Due to some of the values in the Demographic Table 1 are less than 5 so all the values are multiplied by 5 for constructing the following Cross Table 7 to test the hypothesis. Chi- Square test applied to test dependency between gender of the employee and number of promotions received and gender of the participants

M.A. Rahman and M.R.A. Khan (2020) *Int. J. Soc. Sc. Manage. Vol. 7, Issue-4: 191-197*

H_0 : There is an effect of promotion on women's position in the banks.

It is found from Table 8 that χ^2 calculated value is 22.366. At 5% level of significance and 6 degree of freedom the χ^2 table value is 12.60 and the calculated value is 22.366. Here

the calculated value is more than the table value. Therefore, the null hypothesis is rejected and alternative hypothesis supported. Therefore, there is a highly relationship between gender position and number of getting promotion. It is confirmed that there is an impact of up gradation on gender position.

Table 6: Profile of holding positions of the 250 respondents (compiled from field survey)

Position (n=250; 185:65)	Male (M)	Female (F)	Executive Level
General Manager (GM)	1(0.54%)	-	Senior Executive level 0% of female 2.8% (M) & 0% (F)
Deputy General Manager (DGM)	1(0.54%)	-	
Assistant General Manager (AGM)	1(0.54%)	-	
Sr. Assistant Vice President (SAVP)	4 (2.16%)	-	
Senior Principal Officer (SPO)	15 (8.11%)	1(1.54%)	Executive
Principal Officer (PO)	8 (4.32%)	2 (3.08%)	9.2% (M) & 1.2% (F)
Management Trainee Officer (MTO)	5 (3.70%)	-	Entry Level Executive 62% (M) & 25% (F)
Senior Officer (SO)	63 (34.05%)	20 (30.70%)	
Probationary Officer (PO)	3 (1.62%)	-	
Officer	47 (25.41%)	10(15.38%)	
Junior Officer (JO)	37 (20.0%)	32 (49.23%)	

Source: Field Survey 2018.

Table 7: Cross Table containing data on the number of promotions* (developed from Table 1).

Number of promotions	Male	Female	Row (RT)	Measurement
Not given promotion	465	190	655	Level of significance 5%, Degree of freedom (df): (2-1) × (7-1) =6. Chi-Square Test (χ^2) = $\sum (O-E)^2/E$. Where, O= Observed Value, E=Expected Value = (Row Total × Column Total) / Grand Total (Table 7).
One time	190	55	245	
Two times	110	40	150	
Three times	125	20	145	
Four times	15	5	20	
Five times	10	10	20	
Six times	10	5	15	
Column Total (CT) & (RT)	925	325	1250	

Table 8: Calculation for χ^2 value (constructed from Table 7)

O	E	O-E	(O-E) ²	(O-E) ² /E
465	484.70	-19.70	388.09	0.8006
190	170.30	19.70	388.09	2.2788
190	181.30	8.70	75.69	0.4174
55	63.70	-8.70	75.69	1.1882
110	111	-1	1	0.0090
40	39	1	1	0.0256
125	107.30	17.70	313.29	2.9197
20	37.70	-17.70	313.29	8.3100
15	14.8	.20	0.04	0.0027
5	5.2	-.20	0.04	0.0076
10	14.8	-4.80	23.04	1.5567
10	5.2	4.80	23.04	4.4307
10	11.1	-1.10	1.21	0.1090
5	3.90	1.10	1.21	0.3102
$\Sigma (O-E)^2/E = 22.366$				

Conclusion

Presently it is shown that Bangladeshi women are career oriented. Bangladesh has given attention to progress the women empowerment. Lucrative salary packages, congenial working environment along with other opportunities are attracted women's attachment in the corporate service. Today they are now in the service of the banks, telecom industries, airlines professionals, physician, journalism etc. Definitely it is a desired achievement. While doing decisional and operational performances the banks are to consider the welfare of the organization itself and this is why banking organizations recruit the employees those who have ability to do or to show their efficiency and talent. In Bangladesh we could see that the banks are trying to ensure the equal importance as per the policy. Women are promoted as they can. It is done in every sector of the country. The study found that there is gender bias in the banks. It is enhanced to eliminate existing discrimination between men and women (NWD, 2011). Women are recruited and got promotion on due at the lower and middle levels but not at the top level. At the time of recruitment women candidates are few than the male candidates. If this number may be the same as the male candidates it could be overcome. Today women know better how they fight the challenges. In recent women represent themselves half of the world's workforce prospect comprises of 49.6% women. If it is then 26% of the contribution of income will be added in GDP by 2025. It is expected women participation in the job market has been increased since it was 4% in 1974 but it is observed that 35.6% in 2016 (<https://idlc.com/>). Now by keeping pace with the male employees, aside mental stigma and stereotype mentality, women are able to go forward with strong willingness and confidence. The study is done based on a limited location. The researcher thinks that this could be made on a large

scale through taking furthermore study contributing to take more initiatives.

Authors' Contribution

M A Rahman, corresponding author planned and analyzed the research article, M R Azam Khan developed the structure and review the context of the paper. Final version of the research paper has been recognized by authors.

Conflict of Interest

The author has declared that there is no engagement of interest with the existing article and its publication.

Acknowledgement

Authors are grateful to the employees of the respective bank branches operating in the Rangpur City of Bangladesh since they provided information with full cooperation and connection for the study. The authors also like to give special thanks to Mr. H R Basunia (MBA Student, Management Studies, BRUR) for his co-operation for collecting data.

References

- Afza RS and Newaz MK (2008) Factors Determining the Presence of Glass ceiling and Influencing Women Career Advancement in Bangladesh. *BRAC University Journal* 5(1): 85-92.
- Anne RS and Kate H (2010) Management, Women and Gender Capital. *Gender, Work & Organization, and special Issue: Women and Men in Management: Issues for 21st Century* 17: 547- 566.
- Article 29 (2), "No citizen shall, on grounds only of religion, race, caste, sex or place of birth, be ineligible for, or discriminated against in respect of, any employment or office in the service of the Republic".

M.A. Rahman and M.R.A. Khan (2020) Int. J. Soc. Sc. Manage. Vol. 7, Issue-4: 191-197

- BB Official (2017) "Many new banks are not recruiting women employees following Bangladesh Bank's order. That's why the ratio of women bankers is not increasing." *The Asian Age*, 26 April.
- Gender Policy (2014) 3rd Edition, *RDRS Bangladesh*, Sept. 2014: 8-11.
- Internship Report (2016, 2017) Department of Management Studies, BRUR. <https://idlc.com/mbr/article.php?id=203>.
- Kabir LS, Haque M. and Tawfique MMS (2016) Bashing the Glass Ceiling for the Women in Bangladesh Civil Service: An Overview. 2nd World Congress of Political Science, July 23-28, Istanbul, Turkey.
- Kabir SJ (2014) The Impact of Gender Differences on the Conflict Management Styles of Managers in Bangladesh: An Analysis. *Newcastle upon Tyne, UK: Caubridge Scholars Publishing*.
- Kamal RD and Amina S (2014) Gender Gap and Present State of Working Women in Corporate Arena: An Overview of Bangladesh Perspective. *Research on Humanities and Social Sciences*, 4(10): 82-88.
- Mehedi F and Sunon RH (2017) Women in the Banking Sector Fall Far Behind Men. *Observer*, 26 April.
- NWD (2011) Objectives of National Women Development Policy.
- The Constitution (1972) "There shall be equality of opportunity for all citizens in respect of employment or office in the service of the Republic". *The Constitution of the People's Republic of Bangladesh*, Act No. of 1972: Article 29 (1).
- Uddin Z (2013) Gender Discrimination Persist in Bank. *DC: New Age*, June 18.
- UNDP (1993) Report on Public administration sector study in Bangladesh. Dhaka: UNDP.