

University of Rajshahi

Rajshahi-6205

Bangladesh.

RUCL Institutional Repository

<http://rulrepository.ru.ac.bd>

Department of Crop Science and Technology

PhD Thesis

2021

Yield Gap Minimization In Mustard Through Agronomic Management Techniques

Biswas, Girish Chandra

University of Rajshahi, Rajshahi

<http://rulrepository.ru.ac.bd/handle/123456789/1089>

Copyright to the University of Rajshahi. All rights reserved. Downloaded from RUCL Institutional Repository.

YIELD GAP MINIMIZATION IN MUSTARD THROUGH AGRONOMIC MANAGEMENT TECHNIQUES



**THESIS SUBMITTED FOR THE DEGREE
OF
DOCTOR OF PHILOSOPHY
IN THE
DEPARTMENT OF CROP SCIENCE AND TECHNOLOGY
UNIVERSITY OF RAJSHAHI, RAJSHAHI, BANGLADESH**

BY

GIRISH CHANDRA BISWAS
B. Sc. Ag. (Hons.), MS (Plant Pathology)

JUNE, 2021

**DEPARTMENT OF CROP SCIENCE
AND TECHNOLOGY
UNIVERSITY OF RAJSHAHI
RAJSHAHI, BANGLADESH**

DECLARATION

The whole work was submitted as a thesis entitled **“Yield Gap Minimization In Mustard Through Agronomic Management Techniques”** to the Department of Crop Science and Technology, University of Rajshahi, Rajshahi, Bangladesh in partial fulfillment of the requirements for the degree of Doctor of Philosophy (Ph.D) and it was carried out under the supervision of Prof. Dr. Md. Mosleh Ud-Deen, Department of Crop Science and Technology, University of Rajshahi, Bangladesh and under the Co-Supervision of Professor Sanjoy Kumar Adhikary, Agrotechnology Discipline, University of Khulna, Khulna, Bangladesh, Former Vice Chancellor, Nohakhali Science & Technology University, Nohakhali, Bangladesh, Quality Assurance Specialist, Quality Assurance Unit (QAU), Higher Education Quality Enhancement Project (UGC), Ministry of Education, Government of the people’s Republic of Bangladesh.

I, hereby declare that this submission is my own work that to the best of my knowledge and belief, contains no material previously published or written by another person and have not been submitted else for any other degree.

JUNE, 2021

Girish Chandra Biswas

University of Rajshahi



PROFESSOR MD. MOSLEH UD-DEEN

B. Sc. Ag. (Hons.), MS (Crop Botany)
Ph. D. (R.U.), Postdoctoral Research (R.U.)

CERTIFICATE

I hereby certify that the thesis entitled “**Yield Gap Minimization In Mustard Through Agronomic Management Techniques**” has been submitted by **Mr. Girish Chandra Biswas** to the Department of Crop Science and Technology, University of Rajshahi, Rajshahi, Bangladesh for the degree of **Doctor of Philosophy (Ph. D)**.

It is also certified that i) Mr. Girish Chandra Biswas has fulfilled the required residential period, ii) the works embodied in this thesis were carried out by him under my supervision, iii) to the best of my knowledge the data are genuine and original and iv) Any part of the work has not been submitted for any other degree.

(Professor Md. Mosleh Ud-Deen)

Supervisor

Dept. of Crop Science & Technology

Faculty of Agriculture
University of Rajshahi,
Rajshahi-6205, Bangladesh
Telephone: (Off.) +88 0721 711165
Fax: +88 0721 750064
E-mail: uddeenm@yahoo.com

Residence:

“**JOJOK BARI**”, AMBAR, 8B, 335/3,
Dhorompur, Binodpur Bazar, Motihar,
Rajshahi-6026, Bangladesh
Telephone: +88 0721 750478 (Res.)
Mobile: +88 01743 555991, +88 01678517870.

DEDICATED

*TO DEPARTED SOUL OF MY
LATE BELOVED FATHER AND
MY LATE BELOVED MOTHER*

ACKNOWLEDGEMENT

The author deems it a proud privilege to express his deepest sense of thankfulness to the Almighty for his immense blessings upon him for successful completion of the Ph. D. research.

The author renders his gratitude and profound respect to Professor Dr. Md. Mosleh Ud-Deen, Department of Crop Science and Technology, University of Rajshahi; Former Chairman, Department of Crop Science and Technology, University of Rajshahi for his constant guidance, unbound encouragement and constructive suggestions during the course of the present study and critically going through the manuscript.

The author extends his heartiest gratitude to Professor Sanjoy Kumar Adhikary, Agrotechnology Discipline, University of Khulna, Khulna, Bangladesh, Former Vice Chancellor, Nohakhali Science & Technology University, Nohakhali, Bangladesh, Quality Assurance Specialist, Quality Assurance Unit (QAU), Higher Education Quality Enhancement Project (UGC), Ministry of Education, Government of the people's Republic of Bangladesh, for his kind cooperation and encouragement towards completing this research.

The author expresses his sincere thanks to the Chairman, Department of Crop Science and Technology, University of Rajshahi, Rajshahi for providing necessary facilities in conducting the research.

Author is very Much Grateful of the cheep scientific officer and all other scientist specially Simul Kumar Mondal, scientist of Regional Agricultural Research Station (RARS) Jashore Bangladesh for allowing to used land and others facilities for this research work.

Author expresses his Sincere thanks to the scientist Ferdousi Begum and others oil Seed Scientist of Bangladesh Agricultural Research Institute (BARI) for supplying seeds and necessary copies and documents and allowing the author to use their library.

Author also expresses his thanks to Dr. Moshiur Rahman professor of BAU (Bangladesh Agricultural University), Mymensingh for providing necessary documents and articles and for allowing the author to use their library.

Author also remember and express his thanks to scientists of BINA (Bangladesh Institute of Nuclear Agriculture), Mymenshingh for allowing the author to use their library and supplying necessary Documents. The authority of Bangladesh Scientific Documentation Center (BANSDOC) is cordially thanked for supplying various copies of necessary articles and for allowing the author to use their library.

Author is grateful to his late father and late mother whose did not see that the author now came end of his research work. This is great sorrow for the author.

The author also express his deep indebtedness to his brother, sister and all other friends specially Alok Ranjon Nag and other relatives for their blessings and inspiration all times.

Author also expresses his thanks to his son Sworna Surendra Ayon and daughter Rupa Surendra Arthy whose are inspired to done the research works.

It may sound superfluous if the author does not thank his wife Mrs. Manju Rani Roy who kept him away domestics worries.

June, 2021

The author.

CONTENTS

Particulars	Page No.
LIST OF TABLES	I
LIST OF FIGURES	IV
LIST OF PLATES	X
LIST OF APPENDICES	XI
LIST OF APPENDIX PLATES	XII
ABSTRACT	XIII
CHAPTER ONE: INTRODUCTION	1-6
CHAPTER TWO: REVIEW OF LITERATURE	7-55
2.1 Effect of variety on yield contributing characters and yield of mustard	7
2.1.1 Plant height	7
2.1.2 Number of branches plant ⁻¹	9
2.1.3 Number of pods plant ⁻¹	10
2.1.4 Pod length	10
2.1.5 Number of seeds pod ⁻¹	11
2.1.6 1000-seeds weight	12
2.1.7 Seed yield	12
2.2 Effect of sowing time on yield contributing characters and yield of mustard	14
2.2.1 Plant height	14
2.2.2 Number of branches plant ⁻¹	14
2.2.3 Number of pods plant ⁻¹	15
2.2.4 Pod length	19
2.2.5 Number of seeds pod ⁻¹	19

2.2.6	1000-seeds weight	21
2.2.7	Seed yield	22
2.2.8	Straw yield	24
2.2.9	Oil yield	25
2.3	Effect of planting technique on yield contributing characters and yield of mustard	31
2.3.1	Plant height	31
2.3.2	Number of branches plant ⁻¹	31
2.3.3	Number of pods plant ⁻¹	32
2.3.4	Pod length	33
2.3.5	1000-seeds weight	33
2.3.6	Seed yield	34
2.4	Effect of fertilizer on yield contributing characters and yield of mustard	34
2.5	Effect of seed rate on yield contributing characters and yield of mustard	40
2.5.1	Plant height	40
2.5.2	Number of branches plant ⁻¹	41
2.5.3	Number of pods plant ⁻¹	41
2.5.4	Pod length	42
2.5.5	Number of seeds pod ⁻¹	42
2.5.6	1000-seeds weight	42
2.5.7	Seed yield	43
2.6	Effect of plant density or spacing on yield contributing characters and yield of mustard	44
2.7	Effect of water management or irrigation on yield contributing characters and yield of mustard	45
2.8	Effect of variety on growth, yield gap and yield gap minimization of mustard	46

2.9 Effect of sowing time on growth, yield gap and yield gap minimization of mustard	50
CHAPTER THREE: MATERIALS AND METHODS	56-83
3.1 Materials	56
3.1.1 Plant materials used	56
3.2 Methods	60
Experiment 1. Effect of variety on the yield contributing characters and yield of mustard	60
3.2.1.1 Location of the experimental site	60
3.2.1.2 Characteristics of soil	62
3.2.1.3 Climate of the experimental site	62
3.2.1.4 Land preparation	63
3.2.1.5 Design and layout of the experiment	63
3.2.1.6 Experimental treatments	64
3.2.1.7 Manuring and fertilization	64
3.2.1.8 Sowing of seeds	64
3.2.1.9 Intercultural operations	66
3.2.1.9.1 Weeding, thinning and gap filling	66
3.2.1.9.2 Irrigation	66
3.2.1.9.3 Plant protection measure	67
3.2.1.10 Harvesting and processing	67
3.2.1.11 Sampling and data collection procedure	67
3.2.1.11.1 Plant height (cm)	68
3.2.1.11.2 Number of leaves plant ⁻¹	68
3.2.1.11.3 Number of branches plant ⁻¹	68
3.2.1.11.4 Days to flowering	68
3.2.1.11.5 Days to maturity	68
3.2.1.11.6 Pod length (cm)	68

3.2.1.11.7	Number of pods plant ⁻¹	69
3.2.1.11.8	Number of effective pods plant ⁻¹	69
3.2.1.11.9	Number of non-effective pods plant ⁻¹	69
3.2.1.11.10	Number of seeds pod ⁻¹	69
3.2.1.11.11	Number of effective seeds pod ⁻¹	69
3.2.1.11.12	Number of non-effective seeds pod ⁻¹	69
3.2.1.11.13	Number of seeds plant ⁻¹	70
3.2.1.11.14	1000-seeds weight (g)	70
3.2.1.11.15	Seed yield (kg ha ⁻¹)	70
3.2.1.11.16	Straw yield (kg ha ⁻¹)	70
3.2.1.11.17	Oil content (%)	70
3.2.1.11.18	Oil yield (kg ha ⁻¹)	70
3.2.1.12	Statistical analysis	71
Experiment 2. Effect of sowing time and variety on the yield contributing characters and yield of mustard at research field		71
3.2.2.1	Location of the experimental site	71
3.2.2.2	Characteristics of soil	72
3.2.2.3	Climate of the experimental site	72
3.2.2.4	Land preparation	72
3.2.2.5	Design and layout of the experiment	72
3.2.2.6	Experimental treatments	75
3.2.2.7	Manuring and fertilization	75
3.2.2.8	Sowing of seeds	75
3.2.2.9	Intercultural operations	76
3.2.2.9.1	Weeding, thinning and gap filling	76
3.2.2.9.2	Irrigation	76
3.2.2.9.3	Plant protection measure	77

3.2.2.10	Harvesting and processing	77
3.2.2.11	Sampling and data collection procedure	77
3.2.2.11.1	Plant height (cm)	77
3.2.2.11.2	Number of leaves plant ⁻¹	77
3.2.2.11.3	Number of branches plant ⁻¹	78
3.2.2.11.4	Days to flowering	78
3.2.2.11.5	Days to maturity	78
3.2.2.11.6	Pod length (cm)	78
3.2.2.11.7	Number of pods plant ⁻¹	78
3.2.2.11.8	Number of seeds pod ⁻¹	78
3.2.2.11.9	Number of seeds plant ⁻¹	79
3.2.2.11.10	1000- seeds weight (g)	79
3.2.2.11.11	Seed yield (kg ha ⁻¹)	79
3.2.2.11.12	Straw yield (kg ha ⁻¹)	79
3.2.2.11.13	Oil yield (kg ha ⁻¹)	79
3.2.2.12	Statistical analysis	79
Experiment 3. Effect of sowing time and variety on the yield contributing characters and yield of mustard at farmer's field		80
3.2.3.1	Location of the experimental site	80
3.2.3.2	Characteristics of soil	80
3.2.3.3	Climate of the experimental site	81
3.2.3.4	Land preparation	81
3.2.3.5	Design and layout of the experiment	81
3.2.3.6	Experimental treatments	81
3.2.3.7	Manuring and fertilization	81
3.2.3.8	Sowing of seeds	81
3.2.3.9	Intercultural operations	82

3.2.3.10 Harvesting and processing	82
3.2.3.11 Sampling and data collection procedure	82
3.2.3.12 Statistical analysis	82
3.3 Yield gap analysis and strategies for minimizing the gaps of mustard	83
CHAPTER FOUR : RESULTS AND DISCUSSION	84-187
4.1 Effect of variety on the yield contributing characters and yield of mustard	84
4.1.1 Plant height	84
4.1.2 Number of pods plant ⁻¹ and seeds pod ⁻¹	86
4.1.3 Yield contributing characters	88
4.1.4 Yield	89
4.2 Effect of sowing time and variety on the yield contributing characters and yield of mustard at research field.	92
4.2.1 Plant height (cm)	92
4.2.2 Number of leaves plant ⁻¹	97
4.2.3 Number of branches plant ⁻¹	101
4.2.4 Days to 50% flowering	105
4.2.5 Days to maturity	108
4.2.6 Pod length (cm)	111
4.2.7 Number of pods plant ⁻¹	114
4.2.8 Number of seeds pod ⁻¹	115
4.2.9 Number of seeds plant ⁻¹	121
4.2.10 1000-seeds weight (g)	124
4.2.11 Seed yield (kg ha ⁻¹)	127
4.2.12 Straw yield (kg ha ⁻¹)	130
4.2.13 Oil yield (kg ha ⁻¹)	131

4.3 Effect of sowing time and variety on the yield contributing characters and yield of mustard at farmer's field.	137
4.3.1 Plant height (cm)	137
4.3.2 Number of leaves plant ⁻¹	139
4.3.3 Number of branches plant ⁻¹	143
4.3.4 Days to 50% flowering	146
4.3.5 Days to maturity	152
4.3.6 Pod length (cm)	155
4.3.7 Number of pods plant ⁻¹	158
4.3.8 Number of seeds pod ⁻¹	161
4.3.9 Number of seeds plant ⁻¹	164
4.3.10 1000-seeds weight (g)	167
4.3.11 Seed yield (kg ha ⁻¹)	170
4.3.12 Straw yield (kg ha ⁻¹)	173
4.3.13 Oil yield (kg ha ⁻¹)	176
4.4 Yield gap analysis and strategies for minimizing the gaps of mustard.	179
4.4.1 Yield gap analysis	179
4.4.2 Factors causing yield gaps in mustard	183
4.4.3 Strategies for minimizing of yield gaps	185
CHAPTER FIVE: SUMMARY AND CONCLUSION	187-198
REFERENCES	199-218
APPENDICES	219-229

LIST OF TABLES

Table No.	Tittle	Page No.
Table 1.	Effect of variety on the growth of mustard at different days after sowing (DAS).	86
Table 2.	Effect of variety on number of pods plant ⁻¹ and seeds pod ⁻¹ of mustard.	87
Table 3.	Effect of variety on yield contributing characters of mustard.	90
Table 4.	Effect of variety on the yield of mustard.	91
Table 5.	Combined effect of sowing time and variety on plant height (cm) of mustard at different days after sowing in three growing seasons at research field.	95
Table 6.	Combined effect of sowing time and variety on number of leaves plant ⁻¹ of mustard at different days after sowing in three growing seasons at research field.	99
Table 7.	Combined effect of sowing time and variety on number of branches plant ⁻¹ of mustard at different days after sowing in three growing seasons at research field.	103
Table 8.	Combined effect of sowing time and variety on days to 50% flowering of mustard in three growing seasons at research field.	106
Table 9.	Combined effect of sowing time and variety on days to maturity of mustard in three growing seasons at research field.	109
Table 10.	Combined effect of sowing time and variety on pod length (cm) of mustard in three growing seasons at research field.	112
Table 11.	Combined effect of sowing time and variety on number of pods plant ⁻¹ of mustard in three growing seasons at research field.	116
Table 12.	Combined effect of sowing time and variety on no.	119

Table No.	Title	Page No.
	seeds pod ⁻¹ of mustard in three growing seasons at research field.	
Table 13.	Combined effect of sowing time and variety on no. of seeds plant ⁻¹ of mustard in three growing seasons at research field.	122
Table 14.	Combined effect of sowing time and variety on 1000-seeds weight (g) of mustard in three growing seasons at research field.	125
Table 15.	Combined effect of sowing time and variety on seed yield (kg ha ⁻¹) of mustard in three growing seasons at research field.	128
Table 16.	Combined effect of sowing time and variety on straw yield (kg ha ⁻¹) of mustard in three growing seasons at research field.	132
Table 17.	Combined effect of sowing time and variety on oil yield (kg ha ⁻¹) of mustard in three growing seasons at research field.	135
Table 18.	Combined effect of sowing time and variety on plant height (cm) of mustard at different days after sowing in three growing seasons at farmer's field.	140
Table 19.	Combined effect of sowing time and variety on the number of leaves plant ⁻¹ of mustard at different days after sowing in three growing seasons at farmer's field.	144
Table 20.	Combined effect of sowing time and variety on the number of branches plant ⁻¹ of mustard at different days after sowing in three growing seasons at farmer's field.	147
Table 21.	Combined effect of sowing time and variety on days to 50% flowering of mustard in three growing seasons at farmer's field.	150
Table 22.	Combined effect of sowing time and variety on days to maturity of mustard in three growing seasons at farmer's field.	153
Table 23.	Combined effect of sowing time and variety on pod	156

Table No.	Title	Page No.
	length (cm) of mustard in three growing seasons at farmer's field.	
Table 24.	Combined effect of sowing time and variety on no. of pods plant ⁻¹ of mustard in three growing seasons at farmer's field.	159
Table 25.	Combined effect of sowing time and variety on number of seeds pod ⁻¹ of mustard in three growing seasons at farmer's field.	162
Table 26.	Combined effect of sowing time and variety on no. of seeds plant ⁻¹ of mustard in three growing seasons at farmer's field.	165
Table 27.	Combined effect of sowing time and variety on 1000-seeds weight (g) of mustard in three growing seasons at farmer's field.	169
Table 28.	Combined effect of sowing time and variety on seed yield (kg ha ⁻¹) of mustard in three growing seasons at farmer's field.	171
Table 29.	Combined effect of sowing time and variety on straw yield (kg ha ⁻¹) of mustard in three growing seasons at farmer's field.	174
Table 30.	Combined effect of sowing time and variety on oil yield (kg ha ⁻¹) of mustard in three growing seasons at farmer's field.	177
Table 31.	Yield gap and yield gap percentage of mustard between research and farmer's field in the growing season of 2014-2015.	180
Table 32.	Yield gap and yield gap percentage of mustard between research and farmer's field in the growing season of 2015-2016.	181
Table 33.	Yield gap and yield gap percentage of mustard between research and farmer's field in the growing season of 2016-2017.	182
Table 34.	Comparison between demonstration package and existing farmers practice under mustard cultivation.	184

LIST OF FIGURES

Figure No.	Title	Page No.
Figure 1.	Field layout of the experiment 1.	65
Figure 2.	Field layout of the experiment 2 and 3.	74
Figure 3.	Effect of sowing time on plant height (cm) of mustard at different days after sowing in the growing seasons of 2014-2015, 2015-2016 and 2016-2017 in research field.	96
Figure 4.	Effect of variety on plant height (cm) of mustard at different days after sowing in the growing seasons of 2014-2015, 2015-2016 and 2016-2017 in research field.	96
Figure 5.	Effect of sowing time on number of leaves plant ⁻¹ of mustard at different days after sowing in the growing seasons of 2014-2015, 2015-2016 and 2016-2017 in research field.	100
Figure 6.	Effect of variety on number of leaves plant ⁻¹ of mustard at different days after sowing in the growing seasons of 2014-2015, 2015-2016 and 2016-2017 in research field.	100
Figure 7.	Effect of sowing time on the number of branches plant ⁻¹ of mustard at different days after sowing in the growing seasons of 2014-2015, 2015-2016 and 2016-2017 in research field.	104
Figure 8.	Effect of variety on the number of branches plant ⁻¹ of mustard at different days after sowing in the growing seasons of 2014-2015, 2015-2016 and 2016-2017 in research field.	104
Figure 9.	Effect of sowing time on days to 50% flowering of mustard in the growing seasons of 2014-2015, 2015-2016 and 2016-2017 in research field.	107
Figure 10.	Effect of variety on days to 50% flowering of mustard in the growing seasons of 2014-2015, 2015-2016 and 2016-2017 in research field.	107

Figure No.	Title	Page No.
Figure 11.	Effect of sowing time on days to maturity of mustard at different days after sowing in the growing seasons of 2014-2015, 2015-2016 and 2016-2017 in research field.	110
Figure 12.	Effect of variety on days to maturity of mustard in the growing seasons of 2014-2015, 2015-2016 and 2016-2017 in research field.	110
Figure 13.	Effect of sowing time on pod length (cm) of mustard in the growing seasons of 2014-2015, 2015-2016 and 2016-2017 in research field.	113
Figure 14.	Effect of variety on pod length (cm) of mustard in the growing seasons of 2014-2015, 2015-2016 and 2016-2017 in research field.	113
Figure 15.	Effect of sowing time on number of pods plant ⁻¹ of mustard in the growing seasons of 2014-2015, 2015-2016 and 2016-2017 in research field.	117
Figure 16.	Effect of variety on number of pods plant ⁻¹ of mustard in the growing seasons of 2014-2015, 2015-2016 and 2016-2017 in research field.	117
Figure 17.	Effect of sowing time on number of seeds pod ⁻¹ of mustard in the growing seasons of 2014-2015, 2015-2016 and 2016-2017 in research field.	120
Figure 18.	Effect of variety on number of seeds pod ⁻¹ of mustard in the growing seasons of 2014-2015, 2015-2016 and 2016-2017 in research field.	120
Figure 19.	Effect of sowing time on number of seeds plant ⁻¹ of mustard in the growing seasons of 2014-2015, 2015-2016 and 2016-2017 in research field.	123
Figure 20.	Effect of variety on number of seeds plant ⁻¹ of mustard in the growing seasons of 2014-2015, 2015-2016 and 2016-2017 in research field.	123
Figure 21.	Effect of sowing time on 1000-seeds weight (g) of mustard in the growing seasons of 2014-2015, 2015-2016 and 2016-2017 in research field.	126

Figure No.	Title	Page No.
Figure 22.	Effect of variety on 1000-seeds weight (g) of mustard in the growing seasons of 2014-2015, 2015-2016 and 2016-2017 in research field.	126
Figure 23.	Effect of sowing time on seed yield (kg ha ⁻¹) of mustard in the growing seasons of 2014-2015, 2015-2016 and 2016-2017 in research field.	129
Figure 24.	Effect of variety on seed yield (kg ha ⁻¹) of mustard in the growing seasons of 2014-2015, 2015-2016 and 2016-2017 in research field.	129
Figure 25.	Effect of sowing time on straw yield (kg ha ⁻¹) of mustard in the growing seasons of 2014-2015, 2015-2016 and 2016-2017 in research field.	133
Figure 26.	Effect of variety on straw yield (kg ha ⁻¹) of mustard in the growing seasons of 2014-2015, 2015-2016 and 2016-2017 in research field.	133
Figure 27.	Effect of sowing time on oil yield (kg ha ⁻¹) of mustard in the growing seasons of 2014-2015, 2015-2016 and 2016-2017 in research field.	136
Figure 28.	Effect of variety on oil yield (kg ha ⁻¹) of mustard in the growing seasons of 2014-2015, 2015-2016 and 2016-2017 in research field.	136
Figure 29.	Effect of sowing time on plant height (cm) of mustard at different days after sowing in the growing seasons of 2014-2015, 2015-2016 and 2016-2017 in farmer's field.	141
Figure 30.	Effect of variety on plant height (cm) of mustard at different days after sowing in the growing seasons of 2014-2015, 2015-2016 and 2016-2017 in farmer's field.	141
Figure 31.	Effect of sowing time on no. of leaves plant ⁻¹ of mustard at different days after sowing in the growing seasons of 2014-2015, 2015-2016 and 2016-2017 in farmer's field.	145

Figure No.	Title	Page No.
Figure 32.	Effect of variety on no. of leaves plant ⁻¹ of mustard at different days after sowing in the growing seasons of 2014-2015, 2015-2016 and 2016-2017 in farmer's field.	145
Figure 33.	Effect of sowing time on the number of branches plant ⁻¹ of mustard at different days after sowing in the growing seasons of 2014-2015, 2015-2016 and 2016-2017 in farmer's field.	148
Figure 34.	Effect of variety on the number of branches plant ⁻¹ of mustard at different days after sowing in the growing seasons of 2014-2015, 2015-2016 and 2016-2017 in farmer's field.	148
Figure 35.	Effect of sowing time on days to 50% flowering of mustard in the growing seasons of 2014-2015, 2015-2016 and 2016-2017 in farmer's field.	151
Figure 36.	Effect of variety on days to 50% flowering of mustard in the growing seasons of 2014-2015, 2015-2016 and 2016-2017 in farmer's field.	151
Figure 37.	Effect of sowing time on days to maturity of mustard in the growing seasons of 2014-2015, 2015-2016 and 2016-2017 in farmer's field.	154
Figure 38.	Effect of variety on maturity of mustard at different days after sowing in the growing seasons of 2014-2015, 2015-2016 and 2016-2017 in farmer's field.	154
Figure 39.	Effect of sowing time on pod length (cm) of mustard in the growing seasons of 2014-2015, 2015-2016 and 2016-2017 in farmer's field.	157
Figure 40.	Effect of variety on pod length (cm) of mustard in the growing seasons of 2014-2015, 2015-2016 and 2016-2017 in farmer's field.	157
Figure 41.	Effect of sowing time on no. of pods plant ⁻¹ of mustard in the growing seasons of 2014-2015, 2015-2016 and 2016-2017 in farmer's field.	160

Figure No.	Title	Page No.
Figure 42.	Effect of variety on number of pods plant ⁻¹ of mustard in the growing seasons of 2014-2015, 2015-2016 and 2016-2017 in farmer's field.	160
Figure 43.	Effect of sowing time on number of seeds pod ⁻¹ of mustard in the growing seasons of 2014-2015, 2015-2016 and 2016-2017 in farmer's field.	163
Figure 44.	Effect of variety on number of seeds pod ⁻¹ of mustard in the growing seasons of 2014-2015, 2015-2016 and 2016-2017 in farmer's field.	163
Figure 45.	Effect of sowing time on number of seeds plant ⁻¹ of mustard in the growing seasons of 2014-2015, 2015-2016 and 2016-2017 in farmer's field.	166
Figure 46.	Effect of variety on number of seeds plant ⁻¹ of mustard in the growing seasons of 2014-2015, 2015-2016 and 2016-2017 in farmer's field.	166
Figure 47.	Effect of sowing time on 1000-seeds weight (g) of mustard in the growing seasons of 2014-2015, 2015-2016 and 2016-2017 in farmer's field.	169
Figure 48.	Effect of variety on 1000-seeds weight (g) of mustard in the growing seasons of 2014-2015, 2015-2016 and 2016-2017 in farmer's field.	169
Figure 49.	Effect of sowing time on seed yield (kg ha ⁻¹) of mustard in the growing seasons of 2014-2015, 2015-2016 and 2016-2017 in farmer's field.	172
Figure 50.	Effect of variety on seed yield (kg ha ⁻¹) of mustard in the growing seasons of 2014-2015, 2015-2016 and 2016-2017 in farmer's field.	172
Figure 51.	Effect of sowing time on straw yield (kg ha ⁻¹) of mustard in the growing seasons of 2014-2015, 2015-2016 and 2016-2017 in farmer's field.	175
Figure 52.	Effect of variety on straw yield (kg ha ⁻¹) of mustard in the growing seasons of 2014-2015, 2015-2016 and 2016-2017 in farmer's field.	175

Figure No.	Title	Page No.
Figure 53.	Effect of sowing time on oil yield (kg ha ⁻¹) of mustard in the growing seasons of 2014-2015, 2015-2016 and 2016-2017 in farmer's field.	178
Figure 54.	Effect of variety on oil yield (kg ha ⁻¹) of mustard in the growing seasons of 2014-2015, 2015-2016 and 2016-2017 in farmer's field.	178

LIST OF PLATE

Plate No.	Title	Page No.
Plate 1.	Location map of the study area.	61

LIST OF APPENDICES

Appendix Table No.	Title	Page No.
Appendix Table 1.	Physical and chemical properties of soil of the experimental field.	220
Appendix Table 2.	Monthly average meteorological report of the study area during the growing season of 2013-2014.	221
Appendix Table 3.	Monthly average meteorological report of the study area during the growing season of 2014-2015.	222
Appendix Table 4.	Monthly average meteorological report of the study area during the growing season of 2015-2016.	223
Appendix Table 5.	Monthly average meteorological report of the study area during the growing season of 2016-2017.	224

LIST OF APPENDIX PLATE

Appendix Plate No.	Title	Page No.
Appendix Plate 1.	Researcher showing seeds in the experimental field and tagging the Indent Plants.	225
Appendix Plate 2.	Researcher with his supervisor and co-supervisor and farmer is weeding in the farmer's field.	226
Appendix Plate 3.	Researcher observed the plant growth in the research Field and researcher with his farmer in the farmer's field.	227
Appendix Plate 4.	Researcher with his Supervisor & Team Members of Rajshahi University, Researcher observed the harvesting time.	228
Appendix Plate 5.	Seeds with pods of different varieties of mustard used in this study.	229
Appendix Plate 6.	Seeds of different varieties of mustard used in this study.	230

ABSTRACT

To find out the yield gap, causes of yield gap and to minimize yield gap of mustard (*Brassica Sp.*) through agronomic management techniques, there were 03 (three) different experiments were conducted. From first experiment, 04 (four) most potential mustard varieties were selected for next experiments. The second and third experiment was conducted at research field and at farmer's field with four mustard varieties viz. BARI Sarisha 9, BARI Sarisha 11, BARI Sarisha 14, BARI Sarisha 15 and three different sowing times viz. 30th October, 10th November and 20th November in three different growing seasons. Then the yield gap analysis, the causes of yield gap and strategies for minimizing the yield gaps of mustard were find out.

In this study different treatments showed significant influence on yield contributing characters and yield of mustard in the growing seasons of 2014-15, 2015-16 and 2016-17 both at research and farmer's field.

In general BARI Sarisha 11 with 10th November sowing time gave the maximum plant height, no. of leaves plant⁻¹, no. of branches plant⁻¹, days to 50% flowering, days to maturity, pod length, no. of pods plant⁻¹, no. of seeds pod⁻¹, no. of seeds plant⁻¹, 1000-seeds weight and finally seed, straw and oil yield whereas the minimum values of above parameters were obtained from BARI Sarisha 9 with 20th November sowing time in all three growing seasons. Effect of different variety and sowing time on yield contributing characters and yield of mustard was noticeable. BARI Sarisha 11 produced the highest values and BARI Sarisha 9 gave the lowest values. On the other hand, values of all yield contributing characters were found to be decreased with increasing the date of sowing after 10th November. The highest yield gaps of mustard between research and farmers field were 395.00 kg ha⁻¹ with 17.99%, 480.00 kg ha⁻¹ with 21.05% and 471.00 kg ha⁻¹ with 20.60% from BARI Sarisha 11 with 10th November showing time in the growing seasons of 2014-15, 2015-16 and 2016-17.

Biological factors, socio-economic factors, climatic factors, institutional/Government policy related factors and technology transfer factors are considered for causing yield gaps of mustard.

For minimizing the yield gaps of mustard the following strategies should be taken: promotion of integrated crop management, to adopt modern agronomic management techniques, adequate input and credit supplies and research, extension and policy support.

CHAPTER ONE

INTRODUCTION

Introduction

Mustard (*Brassica sp.*) is one of the most important and widely grown oilseed crops of Bangladesh that belongs to the genus *Brassica* under the family Brassicaceae (previously known as Cruciferae) and has several cultivated species viz. *Brassica campestris*, *Brassica juncea*, *Brassica napus*, *Brassica nigra*, *Brassica rapa* etc. It is commonly known as “Sarisha” in Bangla and is being cultivated throughout Bangladesh during winter season (October to March). It is a cool season, thermo-sensitive as well as photosensitive crop (Ghosh and Chatterjee, 1988). The English word mustard derives from the Anglo-Norman mustarde and old French mostrate (modern French is moutrade). The first word is ultimately from Latin mustum, (“must”, young wine) the condiment was originally prepared by making the Mustard seeds into a paste with must.

It is extensively grown traditionally as a pure crop as well as intercrop or mixed crop in marginal and sub-marginal soils in the eastern, northern and north western district of Bangladesh. Among the oilseed crops grown in Bangladesh, mustard holds the first position in terms of area and production as of 2,94,737 ha and 1,94,000 tons, respectively (BBS, 2013).

Mustard oil has six percent saturated fat, which is lower than any other vegetable oil. It is also composed of 58% monosaturated fat, a desirable trait to consumers. Mustard Oil Cake is a safe protein source in animal feeds having 32-38% protein (Myers, 1995). In Bangladesh context, it is popular edible oil in rural area and is considered important for improving

the taste of a number of food items. It also serves as an important raw material for industrial use such as in soap, paints, varnishes, hair oils, lubricants, textile auxiliaries and pharmaceuticals etc. The oil is also used by villagers for hair dressing and massage of the bodies before bath. Oil cakes (contains near about 40% protein) are used as animal feeds and manures. Plant parts are also used as fuel. Mustard oils have several medicinal uses. In Ayurveda medicine, it is believed that mustard oil boiled with few cloves of garlic can be used to cure some forms of influenza (Khaleque, 1989). It has an excellent export potential crop.

Mustard seeds contain 40-45% oil and 20-25% protein. About 13.2% of the annual world edible oil supply comes from this crop (FAO, 2007). Mustard is not only a rich source of energy (about 9 kcal g⁻¹), but also rich in fat soluble vitamins like A, D, E and K. Bangladesh is running a short of 60-75% of the demand of edible oil (Rahman, 2002). The country has to import more or less 1.9 million tons of edible oil. In 2007-08, around BDT 1, 35,328 million was spent for the import of 1.92 million tons of edible oil. Among the edible oil crop cultivation in 2008-09, rapeseed and mustard occupy more than 65.91% and sesame occupies 9.23% of the total oilseed area being the largest and the second largest oilseed crop respectively (Akbar, 2011).

The average per hectare yield of mustard in this country is alarmingly very poor compared to that of advanced countries like Algeria, Germany, France, UK, Poland and Canada producing 6667 kg ha⁻¹, 5070 kg ha⁻¹, 3264 kg ha⁻¹, 3076 kg ha⁻¹ respectively (FAO, 2011). Annual requirement of edible oil is about 5 lakh metric tons. Yield and its formation process depend on genetic, environmental and agronomic factors as well as the interaction between them (Sidlauskas and Bernotas, 2003). Therefore,

there is a scope to increase the yield level of mustard by using HYV seed and by adopting proper management practices such as date of seedling, seed rate, irrigation, fertilizer application and other cultural operations. Optimum seed rate plays an important role in producing higher yield.

Sowing time and fertilizer management are the two most important reasons to improve the yield of mustard in Bangladesh. (Rahman *et al.*, 1988; Mondal and Islam, 1993 and Mondal *et al.*, 1999). The seed yield and maturity of mustard plants are greatly influenced by environmental conditions regardless of proper sowing times. Different sowing dates effect on variable environmental conditions within the same location for growth & development of crop and yield stability (Pandey *et al.*, 1981). So, environmental factors greatly affect plant growth and yield. That is why; sowing date is an important determinant of crop yield. It depends on the onset of significant rainfall, temperature and humidity of a region. Decreasing crop yield in delayed sowing date has been reported by many workers (Degenhardt and Kondra, 1981). Determining suitable planting date plays an important role in conformation of plant growth stages with desirable environmental conditions which results in maximum yield.

Studies have shown that low and high temperatures during flowering stage are the main factors decreasing grain crops through inoculating pollens (Sharief and Kheshta, 2002). Cultivation of mustard with poor fertilizer management is the major causes for poor yield of mustard in the country (Alam and Rahman, 2006). High yield potential of a variety is the prerequisite for increasing the production of a crop. In the recent years, Bangladesh Agricultural Research Institute (BARI) has developed a number of high yielding varieties of mustard with yield potential up to

2.5 t ha⁻¹. The present national average yield of mustard is only 0.79 t ha⁻¹ (Anon, 2006).

Edible oil plays a key role as a source of high energy component of food in human nutrition. Vegetable fats obtained from plant sources are safe for consumption for its cholesterol free nature. Bangladesh is facing chronic shortage for edible oil for several decades. Annually, about 0.17 million tons of edible oil is produced in the country, meeting around 30% of our demand. Farmers mostly grow the traditional variety (degenerated) of Tori 7 as Maghi sarisha from long past for its shorter duration (70-80 days) characteristics with average yield of 750 kg ha⁻¹.

The causes for the lower yield are due to low yield potential of the varieties grown from farmers own sources, susceptible to disease and insufficient precipitation when the crops are grown under rain-fed conditions with traditional crop management practices. Mendham *et al.* (1990) mentioned that planting too early also reduces seed yield as because of excessive growth altering before inflorescence initiation and flowering due to longer duration of vegetative phases. Plant produces more number of branches bearing excessive pods resulting in both inter and intra pod and seed combinations within plants and a high rate of seed abortion occurs. Critical plant sizes at inflorescence initiation were however reported by Scott *et al.* (1973), below or above a level of which seed yield of these crops are affected. The main target of this research work is to discuss the causes contributing to yield gaps in crops, suggest strategies to minimize the gaps to increase yield and finally make recommendations mainly to the government/policy makers to develop guidelines or action plans to address the problem.

The concept of yield gaps in crops originated from different constraint studies carried out by International Rice Research Institute (IRRI) during the seventies. The yield gap comprises at least two components. The first component- yield gap I is the difference between experiment/research station yield and the potential farm yield. This component is not exploitable. The second component of yield gap II is the difference between the potential farm yield and the actual average farm yield (Alam, 2006). The yield gap II is the exploitable and can be minimized by deploying research and extension approaches and government interventions, especially institutional issues. In Bangladesh, despite of the technologies developed by different National Agricultural Research System (NARS) institutes and extension agencies to disseminate the technologies, yield gaps exist in different crops of Bangladesh, such as rice, wheat, potato, oilseeds and pulses, etc. that may range from 19% to about 64% of the potential yield (Alam, 2006; OFRD, 2003-2004 & 2008-2009; Roy, 1997; Matin *et al.*, 1996).

It is always a matter of concern for the research managers and development administrators to ensure that the real potential of any crop variety is harvested at the farmer's field. In reality, however, a gap always prevails between what is projected as the potential yield of any variety at research station and what is obtained on organized farm trials and further what is harvested by the farmers themselves. Technically, this is referred as yield gap of different types. The yield gap is defined as the difference between the maximum attainable yield and the farm level yield.

Mendham and Scott (1975) reported that plant from letter sowings more rapidly fulfill the low temperature needs to initiate earlier inflorescence

and flowering. But early initiation restricts leaf production resulting in small plant, fewer pod bearing branches and finally low dry meter yield.

Kiresur *et al.* (2001) analyzed profitability and sustainability of improved oilseeds production technologies for eight annual oilseeds crops. This study also estimated the yield gaps and indicated that there are significant productivity gaps in all the crops. The experiences emanating from those works were the reasons of genesis of this study. Bridging the oilseeds gap aims not only to increase oilseeds production but also it helps to improve the efficiency of land and labour use, reduce production cost and increase food security.

Considering the above facts the present investigation is undertaken to fulfill the following objectives:

1. To find out the effect of varieties on the growth and yield of mustard.
2. To find out the effect of different sowing time on the growth and yield of mustard in the research and farmers field.
3. To identify the yield gap of mustard between research level and farmers level practices.
4. To minimize the yield gap of mustard through agronomic management techniques.
5. To apply the improved production technologies in the farmer's fields for replacing the traditional methods to minimize yield gap.
6. To ensure farmers participations for adaption of modern varieties and improved production technologies to assured increase yield in farmer's field.

CHAPTER TWO

REVIEW OF LITERATURE

Mustard (*Brassica sp.*) is one of the most important and widely grown oilseed crops of Bangladesh and of the world which contributes to a large extent in the national economy. The effects of different agronomic management practices (variety, sowing time, planting technique, fertilizer management, seed rate, spacing/plant density, water management, etc.) on different crop plants have been investigated by different workers in different times. But the research works done on this crop for minimization of yield gap with respect to agronomic management practices not so adequate and thus, a little information regarding this subject matter on mustard have been compiled here. Some of the available and relevant literature pertaining of yield gap minimization in mustard through agronomic management techniques have been reviewed and presented in this chapter.

2.1 Effect of variety on yield contributing characters and yield of mustard

2.1.1 Plant height

An experiment was conducted at the Regional Agricultural Research Station (RARS), Jashore (AEZ11, High Ganges River Floodplain) during 2003-2006 to evaluate the response of different varieties of mustard to boron application. Boron application was made at 0 and 1 kg ha⁻¹. The varieties chosen from *B. campestris* were BARI Sarisha 6, BARI Sarisha 9 and BARI Sarisha 12. The *B. napus* varieties were BARI Sarisha 7, BARI Sarisha 8 and BARI Sarisha 13. Varieties BARI Sarisha 10 and

BARI Sarisha 11 were from the *B. juncea* group. The seed yield was positively and significantly correlated with the yield contributing characters viz. pods plant⁻¹, seeds pod⁻¹, and 1000-seeds weight, but not with plant height and pod length (Hossain *et al.*, 2012).

Laxminarayana and Pooranchand (2000) conducted an experiment during the rabi seasons at Madhira to determine the most suitable mustard (*Brassica juncea*) cultivar and found no significant variations in plant height among the cultivars.

Ahmed *et al.* (1999) stated that the tallest plant (102.56 cm) was recorded in the variety Daulat. No significant difference was observed in plant height of Dhali and Nap-8509.

Zakaria and Jahan (1997) observed that Dhali gave the tallest plant height (142.5 cm) which was similar with Sonali (139.5) and Japrai (138.6cm). The shortest plant height was observed in Tori 7 (90.97 cm) which was significantly shorter than other varieties.

Hussain *et al.* (1996) observed the highest plant height in Narendra (175cm) which was identical with AGA-95-21 (166cm) and Hyola-51 (165cm). The shortest variety was Tori 7.

Mondal *et al.* (1992) found that variety had significant effect on plant height. They found that the highest plant height (134.4) in the variety J-5004, which was identical with SS-75 and significantly taller than JS-72 and Tori 7.

2.1. 2 Number of branches plant⁻¹

The yield contributing characters such as number of primary, secondary and tertiary branches are important determinant of the seed yield of rapeseed and mustard. Varieties among *Brassica* species showed a marked variation in the arrangement of the branches and their number per plant.

BARI (2000) found that under poor management the number of branch plant⁻¹ was higher (4.2) in the variety SS-75 and lower (2.1) in the variety BARI Sarisha 8. Under medium management, best performance was Dhali (5.5) and worst performance was BARI Sarisha 8. Under higher management, highest was in Dhali (5.9) and lowest was in (3.0) Nap-248.

Zakaria and Jahan (1997) found that the local varieties Tori and Rased produced the highest number of primary branches plant⁻¹ (4.07) which were at par with BLN 900. The minimum number of primary branches plant⁻¹ of 2-90 was found in Jatarai which was identical to those found in Hhole-410 and BARI Sarisha 8 varieties.

Hossain *et al.* (1996) state that the varieties were statistically different with respect to number of primary branches plant⁻¹. The maximum number of primary branches was recorded in the Hyola-401 (5.0) and the minimum number was recorded in Semu-249/84. Khaleque (1989) observed 3.9 and 3.1 branches plant⁻¹ in TS-72 and Sonali Sarisha, respectively.

Mondal and Islam (1993) reported that variety had significant effect on plant height. They found the highest plant height (134.4 cm) on the variety J-5004, which was identical with SS-75 and was significantly taller than JS-72 and Tori 7.

Ali and Rahman (1986) found significant variation in plant height of different varieties of rapeseed and mustard.

2.1.3 Number of pods plant⁻¹

Pooran *et al.* (2000) found the highest number of pods plant⁻¹ (180) in GM-1. Jahan and Zakaria (1997) reported that in case of number of pods plant⁻¹, the highest number was recorded in BLN-900 (130.9) which was identical to Dhali (126.3). Tori 7 had the lowest (46.3) number of pods plant⁻¹.

Hossain *et al.* (1996) observed the highest number of pods plant⁻¹ (187.3) in BLN-900 and the lowest (150.4) in Semu 249/84.

Mondal *et al.* (1992) stated that maximum number of pods plant⁻¹ (136) was found in the variety J-5004, which was identical with the variety Tori 7. The lowest number of pods plant⁻¹ (45.9) was found in the variety SS-75.

2.1.4 Pod length

Hossain *et al.* (1996) observed the longest pod (8.07 cm) in BLN-900 and the shortest (4.83 cm) in Hyola-401.

BARI (1992) conducted an experiment during rabi season at Joydebpur, Jashore, Ishurdi and Rajshahi. Five dates of planting (1 October, 16 October, 1 November, 16 November and 1 December) and two genotypes of rapeseed were used. Significant variation due to different dates of sowing was found in respect of pod length and other traits. Pod length showed decreasing tendency with delay in sowing. Highest length (6.8cm) was found from 15 October sowing and lowest (5.8cm) in December sowing.

The shortest pod length (4.62 cm) was found in the hybrid Semu-249/84 which was identical to those of Semu-DNK 89/218, AGH-7 and Tori 7. The longest pod (8.07 cm) was found in BLN-900 and Hyola-401 (Jahan and Zakaria, 1997). Highest pod length was found from Daulat and lowest in Dhali.

2.1.5 Number of seeds pod⁻¹

Hossain *et al.* (2012) found that the number of seeds pod⁻¹ also varied significantly among the varieties due to B application. The average number of seeds pod⁻¹ ranged from 12.00 to 20.67 and 13.22 to 27.44 in the B untreated and treated plots, respectively. The maximum average number of seeds pod⁻¹ (27.44) was recorded in B treated BARI Sarisha 8.

Laxminarayana and Pooranchand (2000) found no significant variations in seeds pod⁻¹ among the cultivars. Das *et al.* (1998) reported that MM - 7 (Mutant) produced the highest number of seeds pod⁻¹ (29.2) followed by MM - 20 (Mutant) (28.0) and BINA Sarisha 4 (27.8) at Dinajpur.

Among the entries Dhali produced the highest number of seeds pod⁻¹ (26.13) which was at par with Sonali (23.5) and Jatorai (22.8) (Jahan and Zakaria, 1997). The lowest number of seeds pod⁻¹ (18.0) was found in Tori 7 which was at par with that in Sampad (20.0), Hyole 401 (20.3), BARI Sarisha 7 (20.5), AGA-95-21 (20.7) and BARI Sarisha 8 (21.6).

Hossain *et al.* (1996) stated that there were significant differences among the varieties with respect to number of seeds pod⁻¹. The maximum number of seeds pod⁻¹ was produce in the hybrid BLN-900 (29.5) and the minimum number was recorded in Tori 7 as well as in Semu-249/84.

Mondal *et al.* (1992) found that the highest number of seeds pod⁻¹ (27.6) in SS-75 which was significantly different from all other varieties. The lowest number of seeds pod⁻¹ (13.8) was found in J-5004.

2.1.6 1000-seeds weight

Mondal and Wahab (2001) observed that thousand seeds weight ranged 2.50- 2.65g in improved Tori 7 (*B. campestris*) and 1.5-7.8 g in Rai (*B. juncea*). BARI (2001) concluded that there was significant variation in 1000-seeds weight of mustard found in different varieties and highest weight of 1000-seeds was found in jamalpur-1 variety and lowest in BARI Sarisha 10.

Karim *et al.* (2000) stated that varieties showed significant influence in weight of thousand seeds. They found higher weight of 1000-seeds in J-3023 (3.43g), J-3018 (3.42g) and J-4008 (3.50g).

Hussain *et al.* (1998) observed significant variation in case of 1000-seeds weight as influenced by different varieties. They found Hyda-401 had the highest 1000-seeds weight (3.4g) and the lowest 1000-seeds weight was recorded in Tori 7 (2.1g). Jahan and Zakaria (1997) found variation in 1000-seeds weight and the highest weight was in the variety BCN-900 (3.37g) and the lowest in Tori 7 (2.27g).

2.1.7 Seed yield

Rahman (2002) stated that yield variation existed among varieties and the highest seed yield was observed in BARI Sarisha 7, BARI Sarisha 8 and BARI Sarisha 11(2.00-2.50 t ha⁻¹) and the lowest yield in variety Tori 7 (0.95-1.10 t ha⁻¹). BARI (2001) showed that seed yield and other yield contributing characters significantly varied among the varieties.

Pooran *et al.* (2000) studied 6 cultivars of mustard and observed that among the mustard cultivars, GM-1 gave the highest seed yield (1050 kg ha⁻¹), followed by Kranti and Pusa Bold (790 and 760 kg ha⁻¹), respectively and Varuna and Sita produced comparable yields (680 and 610 kg ha⁻¹) respectively.

Jahan and Zakaria (1997) stated that yield variation is present in different varieties. They found highest yield in the exotic variety BLN-400 (2013 kg ha⁻¹) and the lowest seed yield was in AGA-95-21 (819 kg ha⁻¹).

Bukhtiar *et al.* (1992) showed that *Brassica carinata* yielded best (1578 kg ha⁻¹) followed by RL18 (1092 kg ha⁻¹) and DGL (828 kg ha⁻¹). The poorest yield (683 kg ha⁻¹) was given by Taranira (*Eruca sativa*). Zaman *et al.* (1991) showed that seed yields of rapeseed and mustard are different in case of different varieties. Chakraborty *et al.* (1991) stated that seed yields are different from species to species.

Mendham *et al.* (1990) observed that seed yield was variable due to varietal difference in species of *B. napus*. Similar findings were obtained by Chay and Thurling (1989), Sharaan and Gowad (1986).

Chaudhury *et al.* (1988) in an experiment on irrigation with four cultivars of *B. juncea* obtained the highest yield from cv. RH-7513 without irrigation and from cv. Varuna with irrigation. Jain *et al.* (1989) observed yield variations in different varieties of *B. juncea*. Mondal *et al.* (1992) found that variety J-5004 produced the highest seed yield ha⁻¹ (1.47t) among four varieties.

2.2 Effect of sowing time on yield contributing characters and yield of mustard

2.2.1 Plant height

Plant height is a varietal character of rapeseed but it may be affected by environmental conditions and cultural operations. Date of seeding has a direct effect on plant height.

Sharma *et al.* (2006) conducted an experiment during Rabi season of 2005-2006 to study the effect of sowing of mustard (*Brassica juncea*). Results showed that plant height was maximum in the crop sown on 22 and 29 October compared to early and late sowing of 6 October and 12 November, respectively.

Singh (2001) observed that crops sown on the second and third week of October were superior in terms of plant height than sowing on the fourth week of October and first week of November. Islam *et al.* (1994) observed a significant lower plant height was observed in crops sown on 2 December, which resulted in 24% shorter plants compared to that of sowing on 2 December.

BARI (1992) reported that sowing date had no influence on plant height. A number of authors also reported that the seeding mustered on 22 October produced the highest plant height (Kandil, 1983; Ansari *et al.*, 1990).

2.2.2 Number of branches plant⁻¹

Sharma *et al.* (2006) conducted an experiment to study the effect of sowing on growth and yield of mustard (*Brassica juncea*). Results showed that branches plant⁻¹ were maximum in the crop sown on 22 and

29 October compared to early and late sowing of 6 October and 12 November, respectively.

Singh *et al.* (2001) reported that crops sown on the second and third week of October gave higher number of branches plant⁻¹ than sowing on the fourth week of October and first week of November. Pooran *et al.* (2000) found that delaying sowing after 8 October resulted in significant reductions in number of branches plant⁻¹.

Islam *et al.* (1994) also observed that delayed sowing significantly reduced branches plant⁻¹ except that the differences were similar between sowings of 04 and 18 November over the varieties. The maximum (4.55) number of branches produced on 20 October and minimum (3.31) on 2 December.

The number of branches plant⁻¹ has a very low direct effect on seed yield but it has a direct positive effect via pods plant⁻¹ (Rahman *et al.*, 1993). Bukhtiar *et al.* (1992) found that early sown crops produced more primary branches than late sown crops on end October and mid-November.

2.2.3 Number of pods plant⁻¹

Raquibullah *et al.* (2006) reported that date of sowing significantly influenced the number of pods plant⁻¹. Sharma *et al.* (2006) found that pods plant⁻¹ were maximum in the crop sown on 22 and 29 October compared to early and late sowing of 6 October and 12 November respectively.

A field experiment was conducted by Panda *et al.* (2004) at Indian Agricultural Research Institute, New Delhi and emphasized that delayed sowing beyond 16th October reduced number of siliqua per plant. In

Bawat (Haryana), Anil Kumar *et al.* (2004) conducted a field experiment and quoted that number of siliqua per plant recorded higher when crop sown on 21st October compared to 7th and 14th October.

Kumar *et al.* (2004) observed that maximum pods plant⁻¹ were recorded when the crop was planted on 21 October. Shivani and Sanjeev (2002) emphasized that crop sown on 25th September and 5th October recorded higher number of siliqua per plant compared to 15th October, 25th October and 4th November sowing. In Titabar (Assam), Kurmi (2002) conducted a field experiment and quoted that number of siliqua per plant recorded higher with 17th November sowing (104) as compared to 14th December sowing.

Angrej Singh *et al.* (2002) observed that number of siliqua per plant was higher in 10 and 30 October sowing compared to 20th November and 10th December sowing. Number of siliqua per plant recorded higher in 14th October sowing compared to 29th October, 13th November and 28 November sowing (Singh and Singh, 2002). In Jodhpur, Raj Singh *et al.* (2001) reported that the number of siliqua per plant recorded significantly higher under October third week sowing (209) as compared to November first week sowing (173).

Pooran *et al.* (2000) observed that delaying sowing resulted in significant reductions in number of pods plant⁻¹. A field experiment was conducted by Zekatte (1999) at the Perloja Research Station, Lithuania on sandy loam soil and reported that early spring sown crop produced more siliqua per plant (63.7 – 66.0).

Buttar and Aulakh (1999) reported that number of siliqua per plant recorded highest in early sowing (25th October). Buttar and Aulakh (1999) observed that pods plant⁻¹ were higher in 25 October (1st date)

sowing. This was due to the fact that under earlier sown crop, the temperature and other climatological parameters played a major role for growth and yield attributes. Berea (1999) found delay in sowing decreased pod number.

Brar *et al.* (1998) stated that early sown crop produced higher number of pods plant⁻¹ compared to late sowing. Sowing at 30 October and 15 November were at par with each other but further delay in sowing caused significant reduction in number of pods plant⁻¹.

In Dhaka (Bangladesh), Thakur and Singh (1998) reported that number of siliqua per plant recorded higher with 5th October sowing (268.6) compared to 19th November sowing (172.9).

Shahidullah *et al.* (1997) reported that the number of siliqua per plant decreased with delay in sowing from 27th October to 6th or 16th November.

At Rajendranagar (Hyderabad), Surekha and Reddy (1996) conducted a field experiment and observed that the number of siliqua per plant recorded higher with 5th October sowing as compared to 5th and 20th November sowing.

Choudhary and Thakuria (1994) observed that number of siliqua per plant recorded significantly higher under 15th November sowing (224) compared to 5th December sowing (50 to 81). At Kanpur, Yadav *et al.* (1994a) reported that crop sown on 5 October recorded significantly higher number of siliqua per plant (454) compared to 25 October sowing (264).

Chandrakar and Urkurkar (1993) reported that the number of siliqua per plant recorded higher with 23rd November sowing (146) compared to 14th December sowing (74). Mondal and Islam (1993) found that the highest

number of pods plant⁻¹ was in the plants of 1 November sowing and the lowest number of pods plant⁻¹ was in the plant⁻¹ of 1 December sowing.

Mondal *et al.* (1992) stated that the number of pods plant⁻¹ decreased in late planting. Maximum number of pods plant⁻¹ was found in the plants of second planting on 16 October. The lowest number of pods plant⁻¹ was in the plants of last planting.

In Udaipur, Rajendra Kumar and Shaktawat (1992) reported that mustard sown on 22nd September recorded higher number of siliqua per plant (169.0) as compared to 8th September sown (151.7).

Kurmi and Kalita (1992) reported that number of siliqua per plant recorded higher with 17th November sowing (192.1) compared to 2nd December sowing (150.4).

In Raipur (Madhra Pradesh), Ghosh and Chatterjee (1988) also reported that fifteen days to one month delay in sowing produced 24 to 57% reduced pods m⁻². According to Saran and Giri (1987) number of pods plant⁻¹ decreased gradually from early (15 October) to later (25 October; 5 November and 15 November) sowings.

In Nainital, Vasi *et al.* (1986) conducted a field experiment and quoted that number of siliqua per plant recorded higher with 27th September sowing (244.4) as compared to 18th October sowing (168.1). Decreased number of pods m⁻² was also reported by some scientists (Scott *et al.* 1973; Mendham and Scott, 1975 and Mendham *et al.* 1981).

2.2.4 Pod length

In New Delhi, Panda *et al.* (2004) conducted a field experiment and suggested that delayed sowing beyond 16th October reduced the length of siliqua. Singh and Singh (2002) reported that length of siliqua recorded higher when crop sown on 14th October as compared to 29th October, 13th November and 28th November sown crop.

Hossain *et al.* (1996) found significant variation in pod length due to sowing time. BARI (1992) conducted an experiment during Rabi season at Joydebpur, Jessore, Ishordi and Rajshahi. Five dates of planting (1 October, 16 October, 1 November, 16 November and 1 December) and two genotypes of rapeseed were used. Significant variation due to different dates of sowing was found in respect of pod length and other traits. Pod length showed decreasing tendency with delay in sowing. Highest length (6.8cm) was found from 15 October sowing and lowest (5.8cm) in December sowing.

2.2.5 Number of seeds pod⁻¹

Raquibullah *et al.* (2006) reported that date of sowing significantly influenced number of seeds pod⁻¹. In Titabar (Assam), Kurmi (2002) conducted a field experiment and reported that the number of seeds per siliqua recorded higher in 17th November sowing (17) compared to 14th December sowing (14). Raj Singh *et al.* (2002) quoted that crop sown on 5th October recorded higher number of seeds per siliqua (13) compared to 5th November sowing (11).

Shivani *et al.* (2002) reported that sowing on 25th September and 5th October recorded significantly higher number of seeds per siliqua as compared to 15th October, 25th October and 4th November sowing.

In Jodhpur, Raj Singh *et al.* (2001) reported the number of seeds per siliqua were higher with October third week sowing (13.62) compared to November first week sowing (11.78). Laxminarayana and pooranchand (2000) found that seeds pod⁻¹ decreased gradually with delay in sowing.

A field experiment was conducted by Zekatte (1999) at the Perloja Research Station, Lithuania on sandy loam soil and observed that early spring sown crop produced higher seeds per siliqua (4.5).

Thakur and Singh (1998) reported that number of seeds per siliqua recorded higher with 5th October sowing (17.5) compared to 19 November sowing (13.9). In Dhaka (Bangladesh), Shahidullah *et al.* (1997) conducted an experiment and observed that with delay in sowing from 27th October to 6th or 16th November decreased the number of seeds per siliqua.

Surekha and Reddy (1996) conducted a field experiment at Rajendranagar (Hyderabad) and suggested that sowing mustard on 5th October resulted in higher number of seeds per siliqua as compared to 5th and 20th November sowing.

The crop sown on 5th October recorded significantly higher number of seeds per siliqua (14.9) as compared to 25th October sowing (13.0) (Yadav *et al.*, 1994b).

Lutman and Duxon (1987) gave another opinion that later planting increased seeds pod⁻¹.

Majumder and Sandhu (1964) found more seeds pod⁻¹ in October sowing. There are, however, some opinions that sowing date has no significant effect on number of seeds pod⁻¹ (Degehardt and Kondra, 1981; Kandil, 1983; Brar *et al.*, 1998).

2.2.6 1000-seeds weight

Panda *et al.* (2004) observed that delay in sowing beyond 16th October reduced 1000- seeds weight. In Hissar, Raj Singh *et al.* (2002) conducted a field trial and reported that crop sown on 5th October recorded higher 1000-seeds weight (5.7 g) as compared to 5th November sown crop (4.4 g). In Ludhiana, Angrej Singh *et al.* (2002) conducted a field trial and revealed that 1000-seeds weight recorded higher in 10th and 30th October sowing as compared to 20th November and 10th December sowing.

Shivani *et al.* (2002) suggested that 1000-seeds weight (g) recorded higher under 25th September and 5th October sowing as compared to 15 October, 25th October and 4th November sowing.

In Jodhpur, Raj Singh *et al.* (2001) observed that crop sown on October third week recorded higher 1000-seeds weight (4.51 g) as compared to November first week sowing (3.77 g).

Brar *et al.* (1998) stated that there was no significant effect of dates of sowing on 1000-seeds weight. Thakur and Singh (1998) quoted that 1000-seeds weight recorded higher with 5th October sowing (3.78 g) as compared to 19th November sowing (3.33 g).

In Rajendranagar (Andhra Pradesh), Surekha and Reddy (1996) conducted a field experiment and reported that 1000-seeds weight recorded higher with 5th October sowing as compared to 5th and 20th November sowing. Chandrakar and Urkurkar (1993) reported that 1000-seeds weight recorded higher in 23rd November sowing (7.15 g) as compared to 14th December sowing (6.13 g). Kurmi and Kalita (1992) suggested that 1000-seeds weight recorded higher in 17th November sowing (3.42 g) as compared to 2nd December sowing (2.74 g).

These findings corroborate the report of Tomer and Mishra (1991). Ghosh and Chatterjee (1988) reported that one month later planting produced 32% reduction in seed weight. Saran and Giri (1987) observed that sowing in 25 October gave 11% higher 1000-seeds weight than that of 15 November sowing.

In Nainital, Vasi *et al.* (1986) conducted a field experiment and observed that 1000-seeds weight recorded higher under 27th September sowing (2.54 g) as compared to 18th October sowing (1.97 g).

2.2.7 Seed yield

Time of sowing is very much important for cultivation of mustard variety. It has a direct effect on seed yield. In general, early plantings of mustard give higher seed yield than late sowing. The Optimum sowing time of individual genotype differs from place to place depending on environment and edaphic conditions.

Awasthi *et al.* (2007) conducted an experiment during the winter (Rabi) season of 2001-02 and 2003-04 at Kanpur, Uttar Pradesh, to evaluate the effect of sowing dates (15 and 30 October). Sowing of variety 'Vaibhav' on 15 October achieved higher seed yield and net monetary return compared to sowing on 30 October. Kumar and Sharma (2006) found that delay in sowing beyond 5 November significantly decreased the yields of Indian mustard.

Panda *et al.* (2004) observed that the crop sown on 16 October recorded a higher seed yield (1945 kg ha⁻¹) than the crops sown on 31 October (1556 kg ha⁻¹) and 15 November (872 kg ha⁻¹). Laskar *et al.* (2004) found that grain yield was maximum in crop sown during the first week of December.

Khan *et al.* (2002) found that the optimum date of sowing was 20 October, recording higher seed yield compared to 5 October and 5 November sowing. Hocking and Stapper (2001) observed that the grain yield of canola at Aria Park was reduced by 35% for a May sowing and by 67% for a July sowing. Canola yield at Cowra was reduced by 45% between early and late May sowing.

BARI (2001) reported that at Joydebpur location, seed yield and other yield contributing characters were significantly varied among the dates of plantings. The highest yield was at first planting (16 November). At Ishurdi, the first planting (5 November) gave the highest seed yield.

Pooran *et al.* (2000) reported that sowing in the first week of October gave significantly higher yield (1106 kg ha⁻¹ compared to sowing on 23 October or 8 November (860 and 646 kg ha⁻¹) respectively. The reduction in yield was 28% and 33% when the crop was shown on 23 October and 8 November, respectively. Delaying sowing after 8 October resulted in significant reductions in yield.

Panwar *et al.* (2000) reported that yield of *Brassica spp.* decreased when sown on 5 November (mean 1.17 t ha⁻¹ compared with 5 or 20 October (1.70 and 1.77 t ha⁻¹) respectively. Buttar and Aulakh (1999) observed that the seed yield of Indian mustard was obtained significantly higher when the crop was shown on 25 October than sown on 15 November and 5 September. Berea (1999) reported that seed yield was influenced by sowing date. The highest yield was given by sowing on 13 August or 5 September. Brar *et al.* (1998) state that crop sown on October 30 recorded highest seed yield (16.5 q ha⁻¹) than 30 November and 15 December sowings.

Mondal and Islam (1993) observed that the highest seed yield plant⁻¹ and seed yield ha⁻¹ were obtained from the October 15 sowing which were similar to 1 November. Seed yield decreased with delayed sowing.

Mondal *et al.* (1992) reported that the highest seed yield ha⁻¹ (1.45 t) was from second planting (16 October) and was significantly different from last planting (16 November). Bukhtiar *et al.* (1992) stated that end September planting produced higher seed yield (1417 kg ha⁻¹) and on 1 September and mid-November produced lowest seed yields (646 and 669 kg ha⁻¹). Seed yield decreased drastically in early and late plantings.

Zaman *et al.* (1991) suggested 18 and 28 October were better over 7 November for higher seed yield, and higher yield was attributed by pods plant⁻¹ and seed pod⁻¹. They observed that the seed yield decreased generally with the delay in sowing in all varieties. This view was strengthened by the finding of Uddin *et al.* (1987). Shah *et al.* (1985) also obtain the highest seed yield of mustard than middle of October sowing in Jashore areas. Shastri and Kumar (1981).

2.2.8 Straw yield

Hossain *et al.* (2012) reported that BARI Sarisha 8 (*Brassica napus*) had the maximum response to B application. On the other hand, BARI Sarisha 11 (*Brassica juncea*) showed the minimum response. The mean yields of *B. campestris* varieties were 2224-2702 kg ha⁻¹, *B. napus* varieties were 2850-3199 kg ha⁻¹, and yields of *B. juncea* varieties were 3080-3528 kg ha⁻¹ for the B control plots.

In Jorhat (Assam), Kurmi and Kalita (1992) suggested that straw yield recorded was higher in 17th November sowing (2224 kg ha⁻¹) as compared to 2nd December sowing (1896 kg ha⁻¹). In Udaipur, Rajendra Kumar and Shaktawat (1992) conducted a field trial and suggested that

sowing of mustard on 22nd September recorded higher straw yield of 5264 kg per ha compared to 8th September sowing (4715 kg ha⁻¹).

Yadav *et al.* (1994) observed that crop sown on 5th October recorded significantly higher straw yield (4370 kg ha⁻¹) as compared to 25th October sowing (3550 kg ha⁻¹). Singh and Singh (2002) conducted a field trial at Faizabad (Uttar Pradesh) and recorded higher straw yield with 14th October sowing as compared to 29th October, 13th November and 28th November sowing.

2.2.9 Oil yield

In Jorhat (Assam), Kurmi and Kalita (1992) reported that oil yield recorded higher with 17th November sowing (388.17 kg ha⁻¹) as compared to 2nd December sowing (818 kg ha⁻¹).

Das *et al.* (1998) reported that sowing mustard on 27th October recorded higher oil yield as compared to 27th November. In Bikaner (Rajasthan), Angrej Singh *et al.* (2002) suggested that oil yield was higher with 10th and 30th October sowing as compared to 20th November and 10th December sowing.

Singh *et al.* (2010) described the row ratio combinations with variation in growth and development of both the component crops are also being deviated, which ultimately affects the yield attributes and yield, but at specific combination land equivalent ratio and yield advantage is definitely augmented. The suitable and appropriate row ratios combination varies from place to place due to change in climate, farming practices and varieties of crops cultivation. The research avenue is adequate with mustard, cereals and pulses intercropping in relation to management of irrigation, fertilizer, genotypes and crop geometry. Intercropped oilseeds

and pulses crop may have the potential for a more efficient use of resources compared to sole crop.

Alam *et al.* (2015) observed the effect of planting dates on the yield of mustard seed. There were five planting dates viz. 25 October, 30 October, 05 November, 10 November and 15 November. Significant variations due to different planting dates were observed in plant height, number of leaves plant⁻¹, number of siliqua plant⁻¹, number of seed siliqua⁻¹, 1000-seeds weight plot⁻¹, yield plot⁻¹ and yield ha⁻¹ of mustard. Results showed that the highest seed yield was 1.50 t ha⁻¹ obtained from 30 October. The lowest seed yield was 1.0 t ha⁻¹ from 15 November. From the results, the best planting date of mustard is on 30 October in the northern parts of Bangladesh.

Kumar *et al.* (2015) explained different treatments comprised three levels of nitrogen (0, 80 and 120 kg ha⁻¹) and one level of phosphorus and potassium (each 50 kg ha⁻¹). The experiment was laid out under randomized block design (RBD) with three replications. There were significant improvement recorded in physicochemical properties viz. pH, electrical conductivity, organic carbon and available NPK levels of soil under mustard crop at all three growth stages i.e. 30 DAS, 60 DAS and at harvest in the plots received N through urea, P through single super phosphate and potassium through muriate of potash. T (N120P50K50) as compared to other treatments. On the basis of results obtained it can be concluded that the balanced use of N along with P and K can substitute the physico-chemical properties and availability in soil of N, P and K significantly.

Keerthi *et al.* (2017) was conducted a field experiment during the winter (*rabi*) season of 2013-14 and 2014-15 at Hisar, Haryana in a split plot design having four dates in the main plot and five nitrogen levels in the sub plots with three replications, to find out the effect of planting dates and nitrogen level on yield attributes and yield of Indian mustard (*Brassica juncea*). Growth characters, yield attributes, yields and qualities were found to be more with 15 October sowing compared to 30 October, 5 November and 15 November sowing dates. Growth characters, yield attributes, yields and qualities increased significantly with successive increase in nitrogen up to 100 kg N ha⁻¹. Integration of 100 kg N ha⁻¹ with 15 October sowing, gave highest amount of seed yield than rest of the combinations of nitrogen levels and sowing dates during both the years.

Jan *et al.* (2017) observed the effect of sowing methods on varietal performance and yield of *Brassica* under agro-climatic conditions of Peshawar valley. The experiment was conducted at Pakistan Academy for Rural Development (PARD), Peshawar in Randomized Complete Block Design (RCBD) with three replications. Three brassica varieties (Zahoor, Abaseen-95 and advance line) and three sowing methods (Ridge, Line, and Broadcast) were studied. Statistical analysis of the data revealed that varieties had a significant effect on days to emergence, emergence m⁻², and days to flowering, number of branches plant⁻¹, number of pods plant⁻¹, and number of leaves plant⁻¹, leaf area, plant height, and seed pod⁻¹. The increases in yield components were recorded for Zahoor variety as compared with abseen-95 and advance line.

Sowing method showed significant effect on emergence m⁻², days to flowering, number of branches plant⁻¹, number of pods plant⁻¹, and number of leaves plant⁻¹, leaf area, plant height, and seed pod⁻¹. The

interactive effect of varieties and sowing methods had significant effect on number of grain pod⁻¹. The data further revealed that plots sown with Zahoor showed maximum emergence m⁻² (48.7), and early days to flowering (87.8), number of branches plant⁻¹ (7.9), number of pod plant⁻¹ (203.1), and number of leaves plant⁻¹ (18.6), leaf area (569.4), plant height (23.7), and seed pod⁻¹ (165.1). It is concluded that Zahoor variety sown on ridge method produced better yield components when compare with other brassica varieties under varying sowing methods.

Yaseen *et al.* (2017) conducted to develop new approach, which is cost-effective and farmer-friendly. Mixing of wastewater with canal water can decrease the aforementioned harmful influence on ecology, soil, and crop. Wastewater mixing with canal water is a judicious decision to decrease the consequence of heavy metal threat on crop growth. The current study elaborated the efficacy of waste and canal water application on growth and yield of field mustard. The results related to the growth and yield revealed that 50:50% waste and canal water application increased growth and yield attributes over canal water having recommended rate of fertilizers application to field mustard.

Verma *et al.* (2018) described the effect of sowing methods and levels of sulphur and boron on yield and economics of mustard (*Brassica compestris* L.). The experiment was laid out in RBD with twelve treatments and replicated thrice. The plot consisted of three levels of sulphur (15, 30 and 45 kg ha⁻¹), two levels of boron (1 and 2 kg ha⁻¹) with two sowing methods (line sowing and broadcasting) along with NPK each at 80:40:40 kg ha⁻¹ respectively, the results revealed that the maximum no. of siliquae plant⁻¹ (144.86), no. of seeds siliqua⁻¹ (41.60),

test weight (3.18 g), seed yield (1.74 t ha⁻¹), harvest index (41.90%) and oil content (44.21%) in the treatment T5 (sulphur 30 kg ha⁻¹ and boron 2 kg ha⁻¹ with line sowing). The maximum total cost of cultivation (34300.68 Rs ha⁻¹) in the treatment T6 and T12 (sulphur 45 kg ha⁻¹ and boron 2 kg ha⁻¹ with line sowing) and (sulphur 45 kg ha⁻¹ and boron 2 kg ha⁻¹ with broadcasting), respectively. The maximum gross return (53860 Rs ha⁻¹) obtained in the treatment T5 (sulphur 30 kg ha⁻¹ and boron 2 kg ha⁻¹ with line sowing). The maximum stover yield (2.70 t ha⁻¹), net return (22899.32 Rs ha⁻¹) and benefit cost ratio (1.82) obtained in the treatment T7 (sulphur 15 kg ha⁻¹ and boron 1 kg ha⁻¹ with broadcasting).

Singh *et al.* (2019) observed the six treatment combinations of two crop establishment techniques (direct seeding of the seed using a seed-drill and establishment of the crop through transplanting) and three dates of sowing i.e. 13th October, 22 October and 01 November during experimental periods. The results revealed that significantly higher values of most of the growth and yield parameters were observed where transplanting of the seedlings was done on 13th October during both the years. Similarly, the seed yield was increased by 15-20% under transplanting techniques over direct seeding of the crop. In conclusion, early establishment of the Indian mustard through transplanting technique could be an alternative option to enhance the productivity of the Indian mustard particularly under the late harvesting of kharif crops.

Matharu *et al.* (2019) explained the yield gap between recommended practices and farmer's practices of rapeseed-mustard crop. Therefore, efforts have been made through frontline demonstrations (FLD) on insect-pest management to demonstrate improved plant protection

technologies to increase productivity of rapeseed-mustard crop in the district. Fifty frontline demonstrations were conducted on rapeseed-mustard covering an area of 20 hectares and the latest mustard aphid; *Lipaphis erysimi* management technologies were exhibited. Farmers were randomly selected from adopted villages for conducting frontline demonstration. The average percent increase in yield of rapeseed-mustard under the demonstration fields over farmer's practices were recorded as 8.11 per cent. Improved insect-pest management practices in rapeseed-mustard Var. GSC-7 gave the highest yield 21.35 q/ha and 21.48 q/ha as compared to the farmers' practice through the average yield was recorded as 19.29 q/ha and 19.75 q/ha in the year 2017 and 2018, respectively. The mean technology gap, extension gap and technology index were found 0.84 q/ha, 1.89 q/ha and 3.75 percent respectively.

Prasad *et al.* (2020) observed the yield gaps between improved package and practices (IP) under Cluster Front Line Demonstrations (CFLDs) and farmers practices (FP) of rapeseed mustard. They found that the yield of rapeseed mustard in IP under irrigated condition range from 9.5 to 14, where as in FP it range between 7.5 to 9.5 g ha⁻¹. The percent increase in yield IP over FP was recorded in the range of 26.67 to 55.56. The extension gap and technological index were range between 2.00-5.0 q/ha and 54.76 percent respectively. The trend of technological gap reflected to farmer cooperation in carrying out demonstrations with on ranging result in subsequent years. The cost benefit ratio was 2.52 and 2.77 under demonstration, while it was 2.09 to 2.35 under control plots. By conducting Cluster Front Line Demonstrations (CFLDs) of proven technologies, yield potential of rapeseed-mustard crop should be enhanced to a great extent with increase in the income level of farming community.

2.3 Effect of planting technique on yield contributing characters and yield of mustard

2.3.1 Plant height

Plant height is a varietal character of rapeseed but environmental conditions and cultural operations may affect it. Planting technique has direct effect on plant height.

Khan *et al.* (2000) carried out an experiment on mustard in saline field at Agricultural Research Institute (ARI) Tamab during 1997-98. Canola (*Brassica napus*) was sown using four different sowing techniques included drill, broadcast, furrow and ridge. The highest plant height found in ridge planting method.

2.3.2 Number of branches plant⁻¹

Hossain *et al.* (2013) reported that sowing method had significant effect on the production of total branches plant⁻¹. Line sowing method produced the highest number of branches plant⁻¹ (8.42). The lowest number of total branches plant⁻¹ (8.03) was observed in the broadcast method.

Sarkees (2013) conducted an experiment at Karda-Rasha /College of Agriculture, Erbil to evaluate the effect of different seeding rates using drill-row and broadcasting sowing methods on growth, seed and oil yields of rapeseed (*Brassica napus* L.) cv. Pactol. Here he found no significant differences in case of number of primary branches of plant due to different sowing methods.

Sarkees (2013) again conducted an experiment at Karda-Rasha /College of Agriculture, Erbil to evaluate the effect of different seeding rates using drill-row and broadcasting sowing methods on growth, seed and oil yields

of rapeseed (*Brassica napus* L.) cv. Pactol. The tallest plants were produced in the drill-row sown plots. (129.5 cm), while the shortest plants were produced with broadcasting sowing (115.2 cm) , this result is in agreement with Khan *et al.* (2000) that the plants of broadcasting sowing are shorter (109.7 cm) than plants of drill sowing method (118.0 cm).

Hossain *et al.* (2013) carried out an experiment at Agronomy field laboratory, Department of Agronomy and Agricultural Extension, University of Rajshahi, to study the effect of irrigation and sowing method on yield and yield attributes of mustard. Sowing method had significant effect on plant height. Line sowing produced the tallest plant (96.51 cm) and the shortest one (94.26 cm) was found at broadcast method.

2.3.3 Number of pods plant⁻¹

Hossain *et al.* (2013) studied that in the closer plant population at broadcasting method, there were competitions for light, space, nutrients and environments and therefore, lowest number of branches plant⁻¹, siliqua plant⁻¹, seeds siliqua⁻¹ and 1000-seeds weight were produced, ultimately seed yield plant⁻¹ was decreased.

Sarkees (2013) reported that individual plants of drill-row sowing produced a higher number of siliquae than those of broadcasting sowing (130.0) and (107.1) respectively.

Khan *et al.* (2000) studied number of siliqua per plant play a major role in yield which was significantly affected by sowing methods. Maximum siliqua per plant were produced by ridge sown plants. The results for the rest three methods (broadcast, furrow and drill) were statistically non-significant.

The number of siliqua or pod per plant is an important yield contributing character of oil seed rape. Several studies suggest that a higher number of siliquae plant⁻¹ has the greatest effect on seed yield on rape and mustard (Mendham *et al.*, 1981; Thurling, 1974; Rahman *et al.*, 1988).

2.3.4 Pod length

Hossain *et al.* (2013) observed that siliqua length was not significantly influenced by sowing method. Numerically, the longest siliqua (5.69 cm) was found at line sowing method and the shortest one was obtained from broadcasting method.

2.3.5 1000 -seeds weight

Sarkees (2013) reported that crop grown with drill-row sowing method showed significantly the highest seed weight as compared to broadcasting which produced lowest seed weight.

According to Hossain *et al.* (2013) the weight of 1000-seeds was not influenced by sowing method. The maximum weight of 1000-seeds (3.49 g) was obtained from line sowing method and the minimum weight of 1000-seeds (3.43 g) was found in broadcasting method.

According to Khan *et al.* (2000) one of the economically most important yield parameter of the crop, the 1000-grain weight and grain yield as affected by sowing method. Crop grown with ridge sowing method showed significantly the highest 1000-grain weight as compared to drill sowing and furrow sowing, while broadcast sown crop produced the lowest 1000-grain weight.

2.3.6 Seed yield

Sarkees (2013) reported that maximum total yield of 1091.9 kg ha⁻¹ was obtained when crop was grown by drill-row sowing, which was significantly higher (140.9%) than broadcasting method.

According to Hossain *et al.* (2013) sowing method had significant influence on seed yield. The highest seed yield (1.69 t ha⁻¹) was found from line sowing. Whereas, the lowest seed yield (1.46 t ha⁻¹) was exhibited from the broadcasting method.

Khan *et al.* (2000) found that the maximum grain yield of 1119 kg ha⁻¹ was obtained when crop was grown on ridges which were significantly higher than rest of sowing methods. There were no significant differences between furrow and drill sowing methods observed. The lowest yield was obtained when the seed was broadcasted.

Khan and Muendel (1999) reported that broadcast seeding appeared the worst treatment for seed yield and also resulted with heavy growth of *Avena sativa* (oats) in weed dry weights of 1274 and 1498 g m⁻² respectively.

2.4 Effect of fertilizer on yield contributing characters and yield of mustard

A field experiment, consisting of four levels of recommended dose of fertilizer (NPK & S: 80, 40, 0 & 60 kg ha⁻¹) viz. 75 %, 100 %, 125 % & 150 % of RDF and four varieties of Indian mustard [*Brassica juncea* (L) Czern & Coss.] viz. DMH-1, NRC-HB 506, PAC-437 and Kranti (National Check), was carried out by Meena *et al.* (2013) in split plot design with three replications. Hybrid cultivar DMH-1 performed best in terms of yield and yield attributing characters, followed by NRC-HB 506,

which were found significantly higher over the PAC-436 and Kranti (NC) under different fertility levels. Application of 100 % RDF (80 kg N + 40 kg P₂O₅) produced significantly higher seed yield (2372 kg ha⁻¹) and other yield attributes *viz.* number of primary branches plant⁻¹ (4.55), number of secondary branches plant⁻¹ (9.40), number of siliqua plant⁻¹ (195.35), seed weight (8.27 g plant⁻¹) test weight (4.63), stover yield (4771 kg ha⁻¹), oil content (41.30%) , oil yield (933 kg ha⁻¹), total N uptake (114.94 kg ha⁻¹), total P uptake (27.21 kg ha⁻¹), net return (Rs.36776) and B:C ratio (2.62) as compared to 75 % RDF and found statistically at par with 125 % & 150 % RDF. Hence, the farmers could economically benefited by using DMH-1 Indian mustard hybrid variety with recommended doses of fertilizers.

Rashid *et al.* (2012) was carried out a field experiment in non-Calcareous Floodplain Soil of Spices Research Sub-Station, Lalmonirhat under AEZ 2 during the rabi season of 2007- 2008 and 2008-09. The objectives were to evaluate the effect of boron on the yield of mustard and to screen out the suitable variety tested against different boron levels for maximizing yield. Three varieties of mustard *viz.*, BARI Sharisha 11, 13, and 14 and 5 levels of boron (0, 0.5, 1.0, 1.5 and 2.0 kg ha⁻¹) along with a blanket dose of N120 P35 K65 S20 Zn3.0 kg ha⁻¹were used in the study. Results revealed that BARI Sharisha 11 performed better with 1.5 kg B ha⁻¹ which produced 1.82 t ha⁻¹ seed. However, from regression analysis, a positive but quadratic relationship was observed between seed yield and boron levels. The optimum dose of boron was appeared to be 1.7 and 1.6 kg B ha⁻¹ for Lalmonirhat during 2007-08 and 2008-09, respectively.

Vassilina *et al.* (2012) conducted an experiment during the growing seasons of 2008-2009 (2009), 2009-2010 (2010) and 2010-2011 (2011)

on a meadow chestnut soil at the experimental station “Agro university” of the Kazakh National Agrarian University of Almaty in Kazakhstan to evaluate the effect of mineral, organic fertilizers and their combination on yield and quality of mustard (*Brassica juncea*) in short crop rotations (three year rotations). It has been established that annual application of N75, 70K45 mineral fertilizers or of cow dung (30 t.ha⁻¹) three times a year is necessary to get the seed yield between 23.0 and 24.0 q.ha⁻¹. With fertilization, the product quality enhances, i.e. crude oil content, the maximum quantity of which was recorded in case of cow dung and vermicomposting (3 t ha⁻¹) treatments in the natural and artificial phosphorus conditions.

Piri *et al.* (2011) described that fertilizers are one of the factors ensuring increase of seed yield and quality improvement with simultaneous soil preservation and fertility enhancement. Irrigation and fertilizer management are important agronomic practices for a higher yield. Irrigation facilitates mustard growth and yield in addition to water need. It also ensures availability of different nutrients in crop plants.

Mir *et al.* (2010) was conducted a field experiment on mustard (*Brassica juncea* L. Czern & Coss var. Alankar) at Aligarh to study the effect of different combinations of phosphorous and potassium applied as monocalcium superphosphate and muriate of potash respectively (each at the rate of 30, 60, 90 kg P₂O₅ and K₂O kg ha⁻¹) on yield and yield attributes of mustard. In addition, a uniform dose of urea at the rate of 80 kg N ha⁻¹ was applied. At harvest, various yield characteristics including number of pods plant⁻¹ number of seed pod⁻¹, seed yield and oil yield were studied. The effect of phosphorus alone as well as in combination with potassium was significant. Treatments 60 kg P₂O₅ ha⁻¹ and 60 kg P₂O₅ +

60 kg K₂O ha⁻¹ proved optimum and the increase in seed yield was due to increase in pods plant⁻¹ and seeds pod⁻¹.

Present paper reports the results of the study carried out by Yadav *et al.* (2010) on the effect of varying levels of sulphur (S₀, S₂₀, S₄₀ and S₆₀ kg ha⁻¹) as gypsum and source of bio fertilizer @ 200 g/10 kg of seed inoculated B1 (Azotobacter) on yield of mustard crop and soil properties. The grain yield (kg ha⁻¹) was significantly increased by the application of both sulphur and source of bio fertilizer. The maximum yield was obtained by the sulphur application @ 40 kg ha⁻¹ and by the source of bio fertilizer (B1) @ Azotobacter /10 kg seed inoculates. The interaction between sulphur and bio fertilizer was significant and the maximum increase in yield was obtained by applied sulphur @ 40 kg ha⁻¹ at bio fertilizer (B0, B1) 0 and 200 g Azototobacter/10 kg seed inoculate. The soil samples collected after harvest of mustard crop showed the slight decrease in pH and EC and increase in organic carbon, available nitrogen, phosphorus, potassium and sulphur was recorded by the application of sulphur and biofertilizer applied alone or in conjunction with each other.

This study was conducted by El-Nakhlawy and Bakhashwain (2009) with four canola varieties, Callypso, Pactole, Sero-4 and Sero-6 varieties were tested under four nitrogen fertilizer rates (0.00, 92, 138 and 184 kg N ha⁻¹) to determine the effect of nitrogen fertilizer on the canola (*Brassica napus* L.) seed yield, yield components and seed quality. The results showed that as nitrogen fertilizer rate increased, plant height, number of fruit plant⁻¹, 1000-seeds weight, seed weight plant⁻¹ and protein content increased. However oil content (%), was the highest under 92 kg nitrogen rate, then significantly decreased under the higher nitrogen rates. In terms of variety differences, the plant height data revealed that Sero-4 was the taller, followed by Sero-6, and then Callypso and Pactole varieties and

Pactale and Sero-6 varieties produced the highest number of fruits plant⁻¹ and significantly dominated over the Sero-4 and Callypso variety. In addition, Pactale and Sero-4 had the highest 1000-seeds weight without significant differences between them, while Callypso variety was the lowest. Pactole variety was also the highest in seed weight plant⁻¹, while Sero-4 and Sero-6 varieties were not significantly different in seed weight plant⁻¹. Pactole variety was the highest in protein content followed with a significant difference by Sero-4, then Sero-6, while the lowest variety in protein content was Callypso variety. The rate of 138 kg N ha⁻¹ produced the highest seed yield ha⁻¹ (1550.51 kg), protein content (28%) and had 34.10% oil content. Oil content of the studied varieties ranged from 37.80% for Callypso variety to 32.04% for Sero-4 variety, and the statistical comparisons showed significant differences among the four studied varieties. Furthermore, iodine value and refractive index of the oil under the effects of nitrogen fertilizer rates were not significantly different from each other and the same behavior of iodine value and refractive index values were detected.

Basak *et al.* (2007) conducted a field experiment was on Non-Calcareous Dark Grey Floodplain Soil to find out the performance of three mustard varieties viz., i) BARI Sarisha 9, ii) BARI Sarisha 12 and iii) Tori 7 (Local) and three fertilizer doses as: F₁= 120-34-64-32-1.5 kg ha⁻¹ NPKSB (HYG), F₂ = 86-26-44-26-1.0 kg ha⁻¹ NPKSB (MYG) and F₃ = 54-60-15 kg ha⁻¹ NPK. The variety BARI sarisha 9 produced the highest seed yield (892 kg ha⁻¹). The fertilizer level of HYG gave higher seed yield (956 kg ha⁻¹). BARI Sharisha 9 gave higher gross return (Tk. 21882 ha⁻¹) and gross margin (Tk.14936 ha⁻¹) under HYG fertilizer level but higher BCR (3.54) was recorded under MYG fertilizer level due to less fertilization cost.

Another studies were carried out by Khan *et al.* (2007) to assess the influence of different levels of potassium fertilization (0, 25, 50, 75, 100, 125 & 150 kg ha⁻¹) on growth, seed yield and oil contents of canola. The results revealed that the highest seed yield (3473 kg ha⁻¹) was obtained with K @ 150 kg ha⁻¹, which was however, at par with treatments where 50,75,100 and 125 kg K ha⁻¹ was applied. While minimum seed yield (2585 kg ha⁻¹) was recorded in case of control i.e. with no K. Oil content progressively decreased with increase of K level with highest (42.86%) in case of control and lowest (37.42%) with a K level of 150 kg ha⁻¹. But a perusal of economic analysis showed that application of 125 kg ha⁻¹ was more economical than all other treatments.

Suleymenova (2000) demonstrated that the alternative fertilization system increases nitrate-N accretion (by 8.7-15.7 %) and labile phosphorus (by 5.6-14.5%) to a less extent than the conventional system, but results in organic matter growth by 0.02- 0.05% versus its initial content. The chemical soil load decreases by 30% versus the conventional fertilization system, while its productivity decreases only by 2-10%. The organic fertilization system efficiency is low in the irrigated crop rotation. The yield decreases by 31%, and the entire crop rotation productivity decreases by 21-27% in the compared cases versus the conventional fertilization system.

Patel *et al.* (1998) specified that the seeds yield, and straw yield was enhanced largely in case of increased quantity of organic and nitrogen fertilizers, while the nitrogen content clearly correlated with the seeds yield.

Sugawe and Sheike (1997) established in their studies that the seeds yield for about 2 years achieved the values of 12.7; 17.2; 19.4; and 20, 1q.ha⁻¹

in case of nitrogen application in the quantity of 0, 40, 80 and 120 kg. ha⁻¹. In this context, the task was set to study the effect of different quantities of mineral and organic fertilizers on the nutrient absorption by mustard plants, their productivity and oil content in the mustard seeds.

Sariev (1983) explained the oil crops such as castor-oil plant, brown mustard and flax, which have high oil content and yielding capacity, along with wheat, sugar beet, corn, soya, safflower, etc. are expected to be very promising for the Southeast region of the republic. They are valuable because oil seeds can be used not only for production needs, but also for technical needs.

2.5 Effect of seed rate on yield contributing characters and yield of mustard

2.5.1 Plant height

Begum (2005) reported that plant height increased with increasing level of seed rate up to 9 kg ha⁻¹ followed by decreased with further increasing seed rate in mustard. Similar result was reported by Jahan (2005) and who observed that plant height increased till 9 kg ha⁻¹ in mustard.

Seed rate has significant effect on plant height in case of mustard variety. Faraji (2004) noted the positive effect of seed rate on plant height in mustard. Walkowshi (2001) conducted an experiment with different seed rate (80, 120, 160 and 200 seeds m⁻²) and obtained the taller plant from 160 seeds and the shortest one from the 80 seeds m⁻².

Mondal *et al.* (1990) from a field experiment found that plant height increased with increasing plant population grown at 28, 34 or 40 plants⁻². Gaffer and Mohammad (1988) observed the effect of 4 seed rates (8, 10,

12 and 14 kg ha⁻¹) and reported that plant height decreased from 12 kg seeds ha⁻¹.

2.5.2 Number of branches plant⁻¹

Angadi *et al.* (2003) reported that seed rate had negative correlation with branch number plant⁻¹ in mustard.

Shrief *et al.* (1990) maintained population density of 30, 60 and 90 plants m⁻² and found that branches plant⁻¹ was significantly or in the plant density of 30 plants m⁻² compared those of 60 and 90 plants m⁻².

Singh and Singh (1987) found that increased seed rate significantly decreased the total branches plant⁻¹ in mustard.

2.5.3 Number of pods plant⁻¹

Jahan (2005) conducted an experiment to determine the effects of seed rate (6, 9 and 12 kg ha⁻¹) on the yield and yield components of mustard and observed that number of pods plant⁻¹ decreased with increasing seed rate although the highest yield per unit area was recorded in 9 kg seeds ha⁻¹. Similar result was also reported by Begum (2005) and Behera *et al.* (2002) in mustard.

Angadi *et al.* (2003) reported that with increase of seed rate, the number of pods plant⁻¹ decreased in mustard. Similar result was also reported by Mcvettey *et al.* (1988) in mustard.

2.5.4 Pod length

Angadi *et al.* (2003) reported that with the decrease of seed rate of mustard, size of pod length increased. Bryan *et al.* (2001) observed that seed rate between 10 and 15 ft^2 had no significant effect on pod length.

Miah *et al.* (1987) reported that increased seed rate influenced pod length negatively. Similar result was also reported by Gupta (1988) in mustard.

2.5.5 Number of seeds pod⁻¹

Jahan (2005) reported that the number of seeds pod⁻¹ had negative association with seed rate i.e. increasing seed rates decreased the number of seeds pod⁻¹ in mustard. Begum (2005) conducted an experiment to know the effect of seed rate (7 and 9 kg seeds ha^{-1}) on yield and yield attributes of mustard and reported that seed rate had no significant influence on the number of seeds pod⁻¹ in mustard. Similar result was reported by Faraji (2004).

BINA (2004) reported that increasing seed rate up to 8 kg ha^{-1} had no significant influence on seeds pod⁻¹. Angadi *et al.* (2003) reported that with the decrease of seed rate of mustard, number of seeds pod⁻¹ decreased.

2.5.6 1000-seeds weight

Hassan (2005) conducted an experiment to know the effect of seed rate (6, 9 and 12 kg ha^{-1}) on yield and yield attributes of mustard and reported that seed rate had no significant influence on 1000-seeds weight up to 12 kg seeds ha^{-1} .

BINA (2004) reported that up to 10 kg seeds ha^{-1} had no significant influence on 1000-seeds weight in the case of broadcasting and thereafter

further increasing seed rate, 1000-seeds weight significantly reduced. This result was in consistent with the result of Begum (2005) who reported that seed rate up to 9 kg ha⁻¹ had no significant influence on 1000-seeds weight.

2.5.7 Seed yield

Jahan (2005) conducted an experiment at 6, 9 and 12 kg seeds ha⁻¹ of mustard and reported that the seed rate of 9 kg ha⁻¹ produced the highest seed yield (1.64 t ha⁻¹) while the lowest was recorded as 610 kg seeds ha⁻¹ (1.31 t ha⁻¹).

Faraji (2004) conducted an experiment to know the effect of seed rate (6, 8 and 10 kg ha⁻¹) and reported that sowing rates of 6, 8 and 10 kg ha⁻¹ resulted in grain yield of 4061, 3696 and 3622 kg ha⁻¹ respectively.

Angadi *et al.* (2003) reported that reducing plant population by half from 80 to 40 plants m⁻² did not reduce seed yield but seed yield declined as population dropped below 40 plants m². In Bangladesh BARI and BINA are conducting many experiments from 80's to know the optimum seed rate under Bangladesh environmental condition and concluded that 7-8 kg seeds ha was optimum. Singh *et al.* (2002) worked on varying plant densities from 83 to 333 thousand plants ha⁻¹ and found no significant effect on seed yield.

Walkowski (2001) conducted an experiment with different seed rates (80, 120, 160 and 200 seeds m⁻²) and reported that the highest yield was recoiled in 160 seeds m⁻².

Mondal *et al.* (1990) from a field experiment found that mustard crop grown at 28, 34 and 40 plants m⁻² gave yields of 1.27, 1.45 and 1.25 t ha⁻¹ respectively.

2.6 Effect of plant density or spacing on yield contributing characters and yield of mustard

Mamun *et al.* (2014) conducted a field experiment to evaluate the effect of variety and different plant densities on growth and yield of rapeseed mustard during Rabi 2011-12 under rain fed conditions at Sher-e-Bangla Agricultural University, Dhaka, Bangladesh. Four varieties (BARI Sarisha 13, BARI Sarisha 15, BARI Sarisha 16 and SAU Sarisha 3) and four plant densities. BARI Sarisha 13 produced the highest number of branches plant⁻¹ (6.14) which was 33.77% higher (4.59) than BARI Sarisha 15.

Mamun *et al.* (2014) found that the number of seeds siliqua⁻¹ contributes considerably towards the final seed yield. The number of seeds siliqua⁻¹ differed significantly among varieties but not for plant densities, while the interaction effect of variety and plant density was significant. Highest number of seeds siliqua⁻¹ (25.36) was obtained from BARI Sarisha 13 and BARI Sarisha 16 obtained the lowest (14.95).

Mishra and Rana (1992) conducted a field trial at Amar Singh College, Meerut University, Lakhaoti (Uttar Pradesh) and concluded that seed yield recorded higher under 30 cm row spacing (1880 kg ha⁻¹) as compared to 60 cm row spacing (1580 kg ha⁻¹). Sharma (1992) conducted a field experiment at College of Agriculture, Gwalior (Madhya Pradesh) and concluded that a row spacing of 30 cm recorded higher seed yield (1830 kg ha⁻¹) compared to 45 cm row spacing (1635 kg ha⁻¹).

Thakur (1999) conducted a field experiment at Himachal Pradesh Krishi Vishwavidyalaya, Kangra and observed that number of primary and secondary branches per plant were higher in 30 cm row spacing as compared to 20 cm row spacing. Rana and Pachauri (2001) reported that

the number of secondary branches per plant recorded higher in 30×10 cm row spacing (7.6 branches plant).

In Kanpur, Yadav *et al.* (1994a) reported that a row spacing of 45×10 cm recorded seed yield higher as compared to 45×20 cm row spacing. Row spacing of 45×10 cm recorded significantly higher seed yield (14.0 kg ha^{-1}) as compared to 40×20 cm (11.4 kg ha^{-1}) (Yadav *et al.*, 1994b).

2.7 Effect of water management or irrigation on yield contributing characters and yield of mustard

Sultana *et al.* (2009) carried out an experiment to evaluate the effect of irrigation and variety on yield and yield attributes of rapeseed. SAU Sarisha 1 and 2 times irrigation produced the highest number of branches per plant (5.43) which was significantly higher than kollania (4.80) and Improved Tori 7 (4.40).

Fashami *et al.* (2012) carried out an experiment to evaluate the effect of irrigation and variety on yield and yield attributes of rapeseed. water stress is the most important factor limiting crops production in the world. Water stress effect could be modified in different ways such as choosing the most appropriate sowing date. To assess the effect of sowing date on yield and yield components of turnip rape (*Brassica campestris* L.-cv. Goldrush) under different irrigation regimes, a field experiment was conducted in Qazvin, Iran during 2010 to 2011 growing season. The experiment was laid out in a three-replicated-randomized complete block, factorial design with four irrigation levels (I: I_1 = normal irrigation (control), I_2 = interruption of irrigation from flowering stage, I_3 = interruption of irrigation from siliqua formation stage and I_4 = interruption of irrigation from seed filling stage) and four sowing date levels (D: D_1 = 2 October 2010, D_2 = 12 October 2010, D_3 = 22 October 2010, D_4 = 1

November 2010). It was shown that seed yield and yield components decreased by postponing the sowing date and water stress. Water stress at flowering stage had the most negative effect on these traits. Study of interaction effects of $D \times I$ on assessed traits revealed that the highest and lowest means were obtained in D1I1 and D4I2, respectively. Postponing the sowing date in all irrigation regimes decrease assessed traits, and flowering stage was the most sensitive stage to water stress in all sowing dates. The highest seed yield obtained in D1I1 by average is 3875 kg ha^{-1} .

2.8 Effect of variety on growth, yield gap and yield gap minimization of mustard

BARI (2001) observed that there were significant variations in case of 1000-seeds weight of mustard in different varieties and the highest weight of 1000-seeds was found in variety Jamalpur-1 and the lowest in BARI Sarisha 10.

BARI (2000) found that the number of primary branches plant^{-1} was higher (4.2) in the variety SS-75 and lower (2.1) in the variety BARI Sarisha- 8 under poor management. Under medium management, the higher number of primary branches plant^{-1} was found in BARI Sarisha 6 (5.5) and lower in BARI Sarisha 8. Under higher management, the highest number of primary branches plant^{-1} was with BARI Sarisha 6 (5.9) and lower (3.0) with Nap-248.

BARI (2000) found that in case of poor management ISD local gave the highest Stover yield (3.78 t ha^{-1}) and the lowest Stover yield (1.30 t ha^{-1}) was reported from Nap-248. In case of medium management, the highest weight (6.22 t ha^{-1}) was same variety and the lowest (3.70 t ha^{-1}) from PT-303 under high management conditions. The highest stover yield of 6.40 t

ha⁻¹ was obtained from the variety Rai-5 and the lowest stover yield of 4.41 t ha⁻¹ was obtained from Tori 7.

Karim *et al.* (2000) observed varieties showed significant variation in the weight of 1000-seeds. They report higher weight of 1000-seeds in J-3023 (3.43g), J-3018 (3.42 g) and J4008 (3.50g). Khaleque (1989) found 3.9 and 3.1 primary branches plant⁻¹ produced in TS-72 and Sonali Sarisha respectively. Mendham *et al.* (1990), Chay and Thurting (1989) found that seed yields were dissimilar due to varietal differences in species of *B. napus*.

Ahmed *et al.* (1999) observed that the tallest plant (102.56 cm) was found in the variety Daulat. No significant difference was reported in plant height of BARI Sarisha 6 and Nap-8509.

Jahan and Zakaira (1997) observed that BARI Sarisha 6 had the tallest plants (142.5 cm) which were at par with Sonali (139.5 cm) and Jatarai (138.6 cm). The shortest plant was found in Tori 7 (70.75 cm). They also found that the local varieties Tori 7 and Sampad produced the highest number of primary branches plant⁻¹ (4.07) which was at par with BLN-900. The minimum Primary branches plant⁻¹ (2.90) was found in Jatarai which was identical to those found in Hyola-40 and BARI Sarisha 8. They also found among the varieties BARI Sarisha 6 produced the highest number of seeds siliqua⁻¹ (26.13) which was at par with Sonali (23.5) and Jatarai (22.8). The lowest number of seeds siliqua⁻¹ (18.0) was observed in Tori 7 which was at par with those of Sampad (20.0), Hyola 401 (20.3), BARI Sarisha 7 (20.5), AGA-95-21 (20.7) and BARI Sarisha 8 (21.6). They also stated yield variation in different varieties. They report the highest yield in the exotic variety BLN-400(2.01 t ha⁻¹) and the lowest seed yield in AGA21 (0.82 t ha⁻¹).

Hussain *et al.* (1996) observed that the highest plant height was in Narendra (175 cm) which was identical with AGA-95 (166 cm) and Hyola-50 (165 cm). They also showed that there was marked statistical variation in number of siliqua plant⁻¹ among the varieties used. They also stated that the varieties were statistical different with respect to number of primary branches. The maximum number of primary branches was recorded in the Hyola-401 (5.0) and the minimum number was recorded in Semu-249/84. They found that BLN-900 had the highest number of siliqua plant⁻¹ (187.3) and the lowest in Semu-249/84 (150.4). They also found that there were significant differences among the varieties with respect to number siliqua⁻¹. The maximum number of seeds siliqua⁻¹ was produced in the hybrid BLN-900 (29.5) and minimum number was recorded in Tori 7 as well as Semu-249/84.

Islam *et al.* (1994) stated that varieties had significant effect on harvest index (%) of mustard. They found the highest harvest index (41.60%) in the variety TS-72 which was identical to Daulat and the lowest in Sonalisarisha (21.90%) followed by Sambal (26.7%).

Mondal *et al.* (1992) observed that variety had significant effect on plant height. They have report the tallest plant (134.4cm) in the variety J-5004, which was identical with the variety Tori 7. The lowest number of seeds plant⁻¹ (45.9) was report in the variety SS-75. They also reported the highest number of seed siliqua⁻¹ (27.6) in SS-75 which was significantly different from all other varieties. Mondal and Wahab (2001) found that weight of 1000-seeds varied from variety to variety and species to species. They report 1000-seeds weight 2.50-2.65 g in case of improved Tori 7 (*B. campestris*) and 1.50.80 g in case of Rai-5 (*B. juncea*).

Bhargava (1991) observed the biological yield, harvest index and siliqua production per plant were responsible for higher seed yield of mustard whereas, biological yield and seed yield was significant and suggested that higher seed yield can be obtained from vigorous genotypes that gives greater biomass.

Bhuiyan (1989), Ali and Rahman (1986) found significant variation in plant height to different varieties of mustard. According to Bhargava and Tomar (1982) the ideotype should combine the major yield attributes of plant height ranges between 100-125 cm. of mustard may differ widely from species to species as well as from variety to variety within the same species (Chakraborty *et al.*, 1991; Zaman *et al.*, 1991 and Chauhan and Bhargava, 1984).

Rahman and Quddus (1988) conducted a preliminary yield trial with 3 *B. juncea* lines (M-127, M-257 and M-284) against a recognized variety Shambal. They reported that there was no significant different between the tested lines and the check variety Shambal for all the characters including seed yield plant⁻¹ and seed yield plot⁻¹ except plant height and the number of primary branches plant⁻¹.

A number of scientists stated from their findings that there as a significant yield differences among the varieties of mustard within the same species (Uddin *et al.*, 1987; Bhagat and Singh, 1987 and Shamsuddin and Rahman, 1977).

Halva *et al.* (1986) stated that seed yield of mustard varied widely among the species but the variation was little within the species. They found that eight varieties of *Brassica juncea* and one variety of *B. nigra* produced an average yield of 1.6 and 0.7 t ha⁻¹ respectively. Similar result was

obtained by Malik (1989) with *Brassica carinata* which produced 49% higher yield than each of *B. juncea* and *B. campestris*.

Bhargava and Tomar (1982) analyzed the biomass production; HI and seed yield for four Brassica ecotypes. They noticed variation in HI values from 27-42% with maximum in Toria early maturing mustard.

Tayo and Morgan (1979) and Allen and Morgan (1972) report that the seed yield of *Brassica* species were depended upon siliqua plant⁻¹.

Yadava *et al.* (1978) suggested that for ensuring high yields in *B. juncea*, the plant height should have more number of siliqua plant⁻¹ (100-125 siliqua plant⁻¹). They also found that for ensuring high yields in *B. juncea*, the plant type should have more number of seed siliqua⁻¹.

2.9 Effect of sowing time on growth, yield gap and yield gap minimization of mustard

An experiment "yield gap analysis of rapeseed-mustard through front line demonstrations in agro climatic zone" BL Meena *et al.* (2012) explained the yield gaps between improved package and practices (IP) under Front line Demonstration (FLD) and farmer's practice (FP) of rapeseed-mustard crop. The study found, the yield of rapeseed-mustard in IP under irrigated conditions. The trend of technology gap reflected the farmer's cooperation in carrying out demonstrations with encouraging results in subsequent years. The cost benefit ratio was 3.19 to 3.52 under demonstration, while it was 2.36 to 2.69 under control plots. By conducting front line demonstration of proven technologies, yield potential of rapeseed-mustard crop be enhanced to a great extent with increase in the income level of the farming community.

Mattigatti *et al.* (2009) analyzed the total yield gap intercultural into three types of yield gaps namely yield gap-I, yield gap-II and yield gap-III. Yield gap-III indicates the yield uncertainty in sericulture. Yield gap-I (33.40%), is found maximum compared to others due to variation in natural resources. Most of the farmers have taken up new and the latest mulberry variety and silkworm hybrids lead to less yield gap-II in the study area. There was significant difference among the reasonable, predictable and the actual yield of mulberry.

Singh *et al.* (2007) described two types of yield gap in terms of technological and extension yield gaps using frontline demonstrations data (FLD) on mustard. He observed that there was positive impact of FLD over existing practices for farming community of Luck now districts they were motivated by the now agricultural technologies applied in the FLD plots. Results showed that use of improved variety.

Awasthi *et al.* (2007) conducted an experiment during the winter (Rabi) season of 2001-02 to evaluate the effect of sowing dates (15 and 30 October) on growth and yield of 2 varieties of mustard [*B. juncea* (L.) Czernj.&Cosson] under rain fed conditions. Sowing of variety 'Vaibhav' on 15 October achieved higher seed yield and net monetary return compared to sowing on 30 October and variety Urwashi.

Raquibullah *et al.* (2006) stated that a field experiment was conducted at the Central Research Station of BARI, Joydebpur, Gazipur, Bangladesh, for two consecutive years (1998-99 and 1999-2000) with *B. campestris* (cultivars Tori 7, TS-72, SS-75, BARI Sarisha 6, BARI Sarisha 9 and BARI Sarisha 12), *B. juncea* (cultivars Rai-5, Daulat, BARI Sarisha 10 and BARI Sarisha 11), and *B. napus* (cultivars BARI Sarisha 7, BARI Sarisha 8 and Nap-248) and three sowing dates, viz., 20 October, 11 November and 5 December to study the performance of rapeseed-mustard

cultivars for early and late sowing situation. Date of sowing significantly influenced plant height, siliqua plant⁻¹, seeds siliqua⁻¹, seed yield, stover dry weight and oil content of seed in both the years. Days to flowering and maturity were different among the different planting time. The highest seed yields (1478 and 1685 kg ha⁻¹) were obtained from the second planting time (11 November) in both the years, which were significantly different from the two other dates of sowing.

Hussain and Kumar (2006) conducted a field experiment during 1999-2000 to 2001-02 to evaluate the effect of sowing date (25 September, 10 October and 25 October) on the performance of Indian mustard. The growth parameters tested were: plant height and green leaf number at 30 and 60 days after sowing, and at harvest; number of primary, secondary and tertiary branches plant⁻¹; siliqua plant⁻¹; siliqua length; seeds siliqua⁻¹; days to 75% flowering; days to maturity; seed yield plant⁻¹; 100-seed weight; and harvest index. All growth and yield parameters were higher under 25 September sowing than later sowing dates.

Kaur *et al.* (2006) conducted a field experiment during 2003-04; the effects of delayed sowing were investigated on growth and yield components of *B. juncea*. The sowing dates included normal sowing date and late sowing date (20 days after normal sowing). Delayed sowing of the crop greatly suppressed various growth and yield components including plant height, numbers of flowers and siliqua and number of seeds per siliqua. The seed yield decreased by about 46% in delayed sown crop.

Takar and Jat (2005) observed the effect of sowing date on aphid incidence was least on early sown (10 October 2000) crops compared to late sown crops (30 October 2000). The highest yield was obtained in

crops sown on 10 October and the crops sown after this date recorded drastic reductions in yield.

Ghanbahadur *et al.* (2005) conducted a field experiment during the winter season of 1999-2001 to determine the effects of sowing dates (15 and 30 November) on the growth and yield of mustard. During the early stages, the relative growth rate and net assimilation rate were significantly higher with 15 November sowing compared to 30th November.

Hundal *et al.* (2004) conducted field experiments were during 1999-2000 and 2000-01 Rabi seasons to study the effects of cultivar and sowing date on crop growth rate (CGR) in mustard. The mustard cultivars Bio-902 and Pusa Bold were sown on different dates (18 October, 9 November and 2 December in 1999 and 30 September, 20 October, 10 November and 30 November in 2000). The CGR computed for different crop growth intervals revealed a peak CGR of 33.7 and 30.4 g m⁻² day⁻¹ for Bio-902 and Pusa Bold, respectively, sown in the first week of November peak CGR of 33.7 and 40.4 g m⁻² day⁻¹ for Bio-902 and Pusa Bold, respectively, sown in the first week of November.

Kumar *et al.* (2004) conducted a field experiment during 1999-2002 to study the performance of tetra ocular mustard (*B. juncea*) cv. RB 9901 compared with bilocular traditional cultivars RH 30 and Laxmi under different sowing dates (7, 14 and 20 October) in light-textured irrigated soils of semiarid climate. Seeds sown on 14 and 21 October took significantly more days to 50% flowering (55 and 57, respectively) and maturity (154 and 156, respectively) compared to 7 October planting. The maximum seed yield (2.98 t ha⁻¹) and yield-contributing parameters (branches per plant, siliqua on main shoot and siliqua per plant) were recorded when the crop was planted on 21 October and increased the seed

yield by 8.5 and 3.5% over that planted on 7 and 14 October, respectively.

Panda *et al.* (2004) conducted a field experiment during the winter season of 1997-98 on sandy-loam soil to study the effect of dates of sowing (16 October, 31 October and 15 November) and cultivars (Synthetic Early Juncea 2 or SEJ 2 and Pusa Bold) on the growth, yield attributes and yield. The crop sown on 16 October recorded a higher seed yield (1945 kg ha⁻¹) than the crops sown on 31 October (1556 kg ha⁻¹) and 15 November (872 kg ha⁻¹). Delayed sowing beyond 16 October significantly reduced growth, yield attributes and yields.

Khan and Tak (2002) reported that six genotypes of Indian mustard, namely Pusa Bold and RLM-619 of mid-early, RL-1359 and RH-30 of medium, and Prakash and RLM-198 of late maturity groups, were evaluated under 3 dates of sowing (5 and 20 October and 5 November) on a clay loam soil. In all the maturity groups of Indian mustard, the optimum date of sowing was 20 October, recording higher seed yield compared to 5 November and 5 sowing.

Kumar *et al.* (2002) investigated the influence of 2 sowing dates (October 21 and November 23) on 1000-seeds weight and seed yield of 10 genotypes of *B. juncea* in rabi season. They reported that in early sown crops performed better than later ones. Seed yield per plant was the highest in genotype RH 9624 in early sown (20.46 g).

An experiment named "Effect of time of sowing on the performance of mustard varieties in the southern region of Bangladesh" conducted by Razzaque *et al.* (2002) and reported that the on-farm experiment was conducted at Multi Location Testing (MLT) site Barguna to determine suitable sowing time and variety of mustard for late sowing situation for the southern Bangladesh during the rabi seasons. In the case of variety,

Daulat and Ishurdi local, sowing could be delayed up to 30 November to obtain a profitable yield of 872.kg ha⁻¹ and 940 kg ha⁻¹, respectively.

Mendham *et al.* (1990) mentioned that planting too early also reduces seed yield as because of excessive growth attaining before inflorescence initiation and flowering due to longer duration of vegetative phases. Plants produce more number of branches bearing excessive pods, resulting in both inter and intra pod and seed competitions within plants and a high rate of seed abortion occurs.

Majumder and Sandhu (1964) and Singh *et al.* (1972) reported that the time of sowing had a significant effect on yield of mustard and the crop sown in the first week of October gave maximum yield. Thurling (1974a) reported that the flowering time in *B. napus* was short with successive delay in sowing but the time taken in *B. campestris* was longer with middle sowing than that with early and late sowing.

The above reviews revealed that the yield of different rapeseed and mustard varieties differed among themselves due to their genetic makeup as expressed by the difference in their plant height, number of branches plant⁻¹, siliqua branch⁻¹, seeds siliqua⁻¹ and 1000-seeds weight. These yield-contributing characters are also influenced by the date of sowings and ultimately the yield of these varieties varies with variable date of sowings. In the present experiment an attempt has been made to see the effect of four varieties of mustard on yield and yield contributing characters as influenced by date of sowings.

Seed rate as well as row spacing has profound effect on the yield and yield attributing characters of mustard. This demands the proper identification of optimum date of seeding and seed rate for it's yield maximization. The information regarding the date of seeding in combination with seed rate in mustard is limited. Some of the relevant findings have been reviewed and presented in this chapter.

CHAPTER THREE

MATERIALS AND METHODS

This chapter presents with the materials and methods that were used in conducting the experiments. It consist of a short description of materials used, location of the experimental plot, characteristics of soil, climate, treatments, land preparation, manuring and fertilization, sowing and gap filling, after cares, harvesting and collecting of data. In the present study, yield gap was computed on the basis of potential yield of four particular varieties of specific regions of selected oilseed crop (mustard). The details of the materials used and techniques adopted during the course of investigation are furnished below:

3.1 Materials

3.1.1 Plant materials used

Seven different varieties of mustard (*Brassica sp.*) namely Tori 7, BARI Sorisha 9, BARI Sarisha 11, BARI Sorisha 13, BARI Sorisha14, BARI Sorisha 15 and BARI Sorisha16 were used in the present experiment. The seeds of different mustard varieties were collected from Bangladesh Agricultural Research Institute (BARI), Joydebpur, Gazipur. These varieties were developed by Bangladesh Agricultural Research Institute (BARI), Joydebpur, Gazipur. The important characteristics of these varieties are described below:

Tori 7

This variety was released by Bangladesh Agricultural Research Institute (BARI), Gazipur, Bangladesh in the year of 1976. It is developed from (origin) local variety. Plant is short and height 60-70cm, primary branch

2-3, pods plant⁻¹ 50-60, two chambered pod and 10-12 seed pod⁻¹. Blooming flower positions at upper on bud because of petiole of flower are long. Fruit or siliqua slight thick, seed round and pringle color and 1000- seeds weight 2.6-2.7 g. Crop duration 70-80 days. It is Rabi season crop and cultivated in mid-October to mid-November. Yield potential of this variety is 900-1000 kg ha⁻¹. Oil content in seed is 38-41%. Moderately waterlog tolerant. Presently, this variety is attacked by disease and insect. So, discourage for cultivation of this variety.

BARI Sarisha 9

This variety was released by Bangladesh Agricultural Research Institute (BARI), Gazipur, Bangladesh in the year of 2000. Origin of the variety is India. Short durated variety, plant height 80-95 cm, 4-6 primary branch are present in each plant, leaf light green and smooth, blooming flower in upright position on axils, stem coated by pedicel of leaf, flower is yellow, number of siliqua plant⁻¹ 80-100, seed color pink, seed siliqua⁻¹ 15-20, 1000-seeds weight 2.5-3.0 g. It is easily cultivated because of short life cycle. Crop duration 80-85 days. It is Rabi season crop and cultivated in mid-October to mid-November. Yield potential of this variety is 1.25-1.45 t ha⁻¹. Oil content in seed is 43-44%.

BARI Sarisha 11

This variety was released by Bangladesh Agricultural Research Institute (BARI), Gazipur, Bangladesh in the year of 2001. Origin of the variety is local and exotic germplasm. Late planting potential, plant height 120-130 cm, 3-5 primary branches are present in each plant, branched is produced from main stem with slight up to soil, leaf light green, leaf with petiole and rough, blooming flower in downward position on axils,

flower yellow, number of siliqua plant⁻¹ 75-150, two chambers are present in pod, seed siliqua⁻¹ 12-15, seed color pink, 1000-seeds weight 3.5-4.0 g, seed weight is greater than another rai sarisa. It is also cultivated as late variety after harvest of aman rice. Crop duration 105-110 days. It is Rabi season crop and cultivated in mid-October to mid-November. Yield potential of this variety is 2-2.5 t ha⁻¹; yield is 20-25% greater than Doylot variety. Oil content in seed is 45-47%. Drought and salt tolerant.

BARI Sarisha 13

This variety was released by Bangladesh Agricultural Research Institute (BARI), Gazipur, Bangladesh in the year of 2004. It is developed by crossing between *B. campestris* and Swedish *B. oleraceae* / *B. alboglabra*. Plant height 85-80 cm, 5-6 primary branches are present in each plant, leaf deep green, smooth and not hairy, leaf without petiole and round half of stem, blooming flower in inflorescence as downward position on bud, flower blooming period long, corolla color of flower is yellow, number of siliqua plant⁻¹ 65-75, 2 chamber are present in pod, seed siliqua⁻¹ 28-30, seed color pink, 1000-seeds weight 3.7-3.9 g. crop duration 90-95 days, It is Rabi season crop and cultivated in mid-October to mid-November. Yield potential of this variety is 2.20-2.80 t ha⁻¹. Oil content in seed is 42-43%. Tolerant to moderately waterlog condition.

BARI Sarisha 14

This variety was released by Bangladesh Agricultural Research Institute (BARI), Gazipur, Bangladesh in the year of 2006. It is developed by crossing between Tori and Sonali Sarisha. Short duration variety, plant

height 75-85 cm, leaf light green, smooth, siliqua plant⁻¹ 80-102, two chambers are present in pod but as like as four chambers. Seed siliqua⁻¹ 22-26, seed color pink, 1000-seeds weight 3.5-3.8 g, crop duration 75-80 days, after harvest aman and before transplant boro it is easily cultivated because of short duration. It is Rabi season crop and cultivated in mid-October to mid-November. Yield potential of this variety is 1.4-1.6 t ha⁻¹. Oil content in seed is 40-45%.

BARI Sarisha 15

This variety was released by Bangladesh Agricultural Research Institute (BARI), Gazipur, Bangladesh in the year of 2006. It is developed from local germplasm. Short durated variety, plant height 90-100 cm, siliqua plant⁻¹ 70-80, two chambers are present in pod, seed siliqua⁻¹ 20-22, pod is narrow and taller than BARI sarisha 14, seed color yellow, 1000-seeds weight 3.25-3.50 g, crop duration 80-85 days, after harvest aman and before transplant boro, it is easily cultivated because of short duration. It is Rabi season crop and cultivated in mid-October to mid-November. Yield potential of this variety is 1.55-1.65 t ha⁻¹. Oil content in seed is 38-42%.

BARI Sarisha 16

This variety was released by Bangladesh Agricultural Research Institute (BARI), Gazipur, Bangladesh in the year of 2013. It is developed by hybridization between BARI Sarisha 15 and Sonali Sarisha. Short duration crop (duration 82-86 days), plant height 95-97 cm, plant don't lodge, pod plant⁻¹ 60-65, seed pod⁻¹ 28-30, flower and seed color yellow, because of yellow seed color comparatively 3-4% oil is greater than brown color seed usually. 1000-seeds weight 3-3.4 g. It is Rabi

season crop and cultivated in mid-October to mid-November. Yield potential of this variety is 1.7-1.8 t ha⁻¹, 5-10% greater yield than BARI Sarisa 14. Tolerant to drought and salt stress, *Alternaria* blight disease and Orabancy parasite.

3.2 Methods

The experiments in the present study were conducted both in farmer's field and research field. The procedures for different experiments in respect of the types of study are stated below:

Experiment 1. Effect of variety on the yield contributing characters and yield of mustard

This experiment was considered as screening and to find out 04 (four) most potential mustard varieties from 07 (seven) different mustard varieties for the next experiments to minimize yield gap. The experiment of the present study was conducted in the farmer's field of the Village - Karimpur, Thana – Bagharpara, Post - Jamdia, District – Jashore during the period from October, 2013 to March, 2014. The procedures used in conducting the experiment have been described below with sub headings.

3.2.1.1 Location of the experimental site

The field experiment was conducted in the farmer's field of Village - Karimpur, Thana – Bagharpara, Post - Jamdia, District- Jashore during the period from October, 2013 to March, 2014. The experimental site was located between 23100.120”N latitude and 89130.120”E longitudes at the elevation of 17m above the sea level belonging to the Agro-Ecological Zone (AEZ-11) “High Ganges River Floodplain” (Plate 1).



Plate 1. Location map of the study area.

3.2.1.2 Characteristics of soil

The general soil types of the experimental field were predominantly included calcareous dark grey floodplain soils and calcareous brown floodplain soils. Organic matter content in the brown ridge soils is low but higher in the dark grey soils. Soils are slightly alkaline in reaction. General fertility level is low. The experimental field was a well-drained medium high land having soil pH 7.17. The analytical data of the soil sample (physical and chemical properties) from the experimental area was determined in the laboratory of Soil Research Institute (SRI), Jashore have been presented in (Appendix Table 1).

3.2.1.3 Climate of the experimental site

The climate of the experimental area is sub-tropical in nature, which is characterized by high temperature, heavy rainfall, high humidity and relatively long day during the months of April to September (Kharif season) and low rainfall associated with moderately low temperature low humidity and short day during the rest of the year (Rabi season). Rabi is more favorable for mustard production. During the growing season 2014-2015 the maximum air temperature (37.7°C) was found in April and minimum (13.8°C) in January. The maximum rainfall (440 mm) was recorded in June and minimum (00 mm) in November and December. The maximum relative humidity (86%) was found in July and minimum (65%) in April. In case of the growing season 2015-2016 the maximum air temperature (36.0°C) was recorded in May and minimum (13.5°C) in January. The maximum rainfall (924mm) was found in July and minimum (00 mm) in January. The maximum relative humidity (91%) was recorded in July and minimum (75%) in March. Growing season 2016-2017 the maximum temperature (36.3°C) was found in April and

minimum (13.0⁰C) in January. The maximum rainfall (643 mm) was recorded in August and minimum (00 mm) in December and January. The maximum relative humidity (88%) was found in July and minimum (74%) in February. The maximum and minimum air temperature, rainfall and relative humidity during the experimental period are presented in Appendix Table (2-5).

3.2.1.4 Land preparation

The land selected for the experiment was opened 15 days before planting (15th October, 2013) of the crop with a disc plough. It was then thoroughly prepared by ploughing and cross ploughing with a power tiller followed by laddering to obtain good tilth. During land preparation, weeds and stubbles were collected and removed from the field and the clods were broken with the help of hand. The surface of the land was leveled. Finally irrigation and drainage channels were made around the plots. Final land preparation was done one week before sowing.

3.2.1.5 Design and layout of the experiment

The experiment was laid out in Randomized Complete Block Design (RCBD) with three replications. The whole field was divided into three blocks and each block consisted of 07 (seven) plots. Altogether there were 21 unit plots in the experiment. Each unit plot was 6.0 m² (3.0 m × 2.0 m) in size. The replication was separated from one another by 1m. The distance between plots was 50 cm. The treatment was randomly assigned to each of the block. Each unit plot had 10 rows and each with of a few number of continuous sowing plants. The plants of one row in each unit plot were considered for growth of mustard and other one row were considered for d contributing characters and yield of mustard. Row to row

distance was 30 cm and plant to plant distance was continuous and 2-3 cm depth furrows. A layout of the experiment has been shown in Figure 1.

3.2.1.6 Experimental treatments

In this experiment 07 (seven) varieties of mustard was taken as treatment viz. V_1 = Tori 7, V_2 = BARI Sarisha 9, V_3 = BARI Sarisha 11, V_4 = BARI Sarisha 13, V_5 = BARI Sarisha 14, V_6 = BARI Sarisha 15 and V_7 = BARI Sarisha 16

3.2.1.7 Manuring and fertilization

The land was fertilized with well decomposed cow dung, urea, triple super phosphate (TSP), muriate of potash (MOP) and gypsum and boric acid at the rate of 10 ton, 250 kg, 180 kg, 90 kg and 150 kg and 6 kg per hectare, respectively (BARC, 1989). The entire quantity of cow dung, TSP, MP, gypsum, boric acid and half of urea were applied at the time of final land preparation. The remaining urea was applied as top dressing in two equal splits at 25 and 50 days after transplanting followed by weeding and irrigation.

3.2.1.8 Sowing of seeds

The seeds of different mustard variety @ 9.0 kg ha⁻¹ were sown on 10th November, 2013 as per treatment @ 9.0 kg ha⁻¹ in rows of raised beds. Row to row and plant to plant spacing were maintained as 30 cm and continuous and 2-3 cm depth furrows, respectively. The seeds were covered with fine soil by hand.

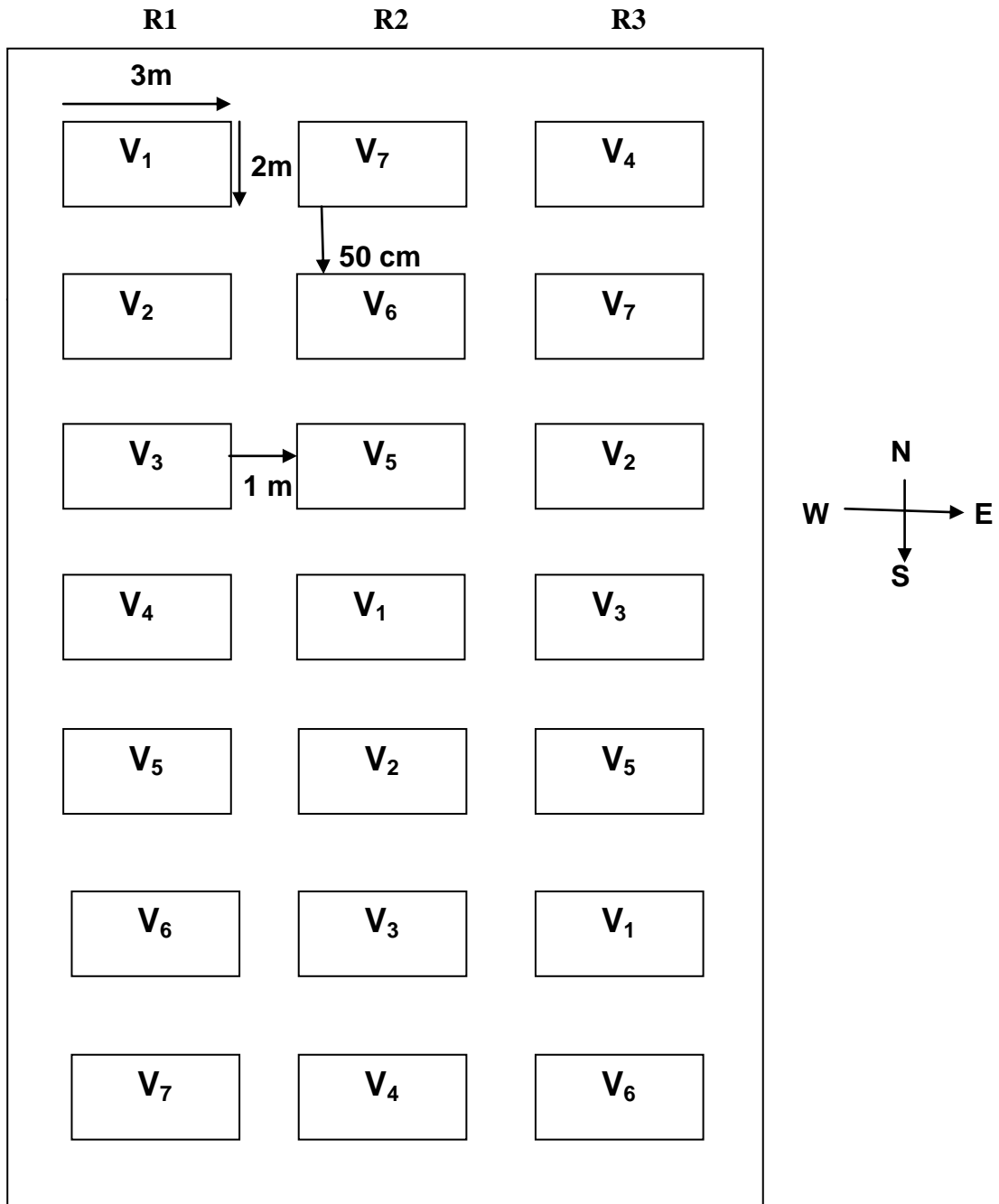

Figure 1. Field layout of the experiment 1.

Legend: Design: Randomized Complete Block Design (RCBD) with 3 replications.

Scaling: Vertical & Horizontal: 1 cm = 2m

Treatments:

- V₁=Tori 7
- V₂=BARI Sarisha 9
- V₃=BARI Sarisha 11
- V₄=BARI Sarisha 13
- V₅=BARI Sarisha 14
- V₆=BARI Sarisha 15
- V₇=BARI Sarisha 16

Total No. of treatments:

Treatment x Replication = 7X3= 21

Unit plot size: 3m X 2m = 6m²

Spacing: Line to line: 30cm

Plant to plant: Continuous and 2-3cm
depth furrow

Between plots: 50cm

Between replications: 1m

3.2.1.9 Intercultural operations

The plants were always kept under careful observation. All necessary intercultural operations were done through the cropping season for proper growth and development of the plant as mentioned below were accomplished.

3.2.1.9.1 Weeding, thinning and gap filling

The experimental plots were found to be infested with different kinds of weeds, viz. Bathua (*Chenopodium album* L.), Durba (*Cynodon dactylon*), Nut sedge (*Cyperus rotundus* L.), Biskatali (*Polygonum hydropiper* L.) etc. Weeding was done manually with “nirani” as per treatment. Two hand weeding were done for each treatment; first weeding was done at 15 days after sowing followed by second weeding at 15 days after first weeding. Thinning was done in all the unit plots with care to maintain a constant plant population on each row. Finally plants were kept at 5 cm distance in rows. Gap fillings was done in place of dead or wilted seedlings in the field using healthy seeding of the same stock previously planted in the border area on the same date of transplanting. The soil around the base of each seedling was pulverized after the establishment of seedlings.

3.2.1.9.2 Irrigation

Irrigation was given in the respective plots to ensure puddle soil. First irrigation was given at 15 days after sowing (DAS) and the second irrigation was given at 55(DAS) following flood method in all the plots.

3.2.1.9.3 Plant protection measure

Crops were attacked by aphids (*Lipaphiserysimi* K). It was controlled by spraying Malathion 57 EC at the rate of 2 ml litre⁻¹ of water. The spraying was done in the afternoon while the pollinating bees were away from the field.

3.2.1.10 Harvesting and processing

The experimental crop was harvested at maturity when 80% of the siliqua turned straw yellowish in color. Harvesting was done in the morning to avoid shattering. Excluding the boarder lines plants were harvested from the of each plot at ground level with the help of a sickle for grain and straw yield. Prior to harvesting, ten plants were sampled randomly from each plot, bundled separately, tagged and brought to a clean cemented threshing floor from which different yield parameters were recorded. The crop was sun dried properly by spreading them over floor and seeds were separated from the siliqua by beating the bundles with the help of bamboo sticks and then cleaned, sun dried and weighed. The harvesting was started from 2 March and completed by 23 March 2013. The seeds thus collected were dried in the sun for reducing the moisture in the seed to about 9% level.

3.2.1.11 Sampling and data collection procedure

In each treatment from net plot, five plants of mustard were randomly selected and tagged. The observations on growth components at different growth stages and yield components at harvest were recorded. Destructive plant sampling was done with plants selected outside the net plot area.

3.2.1.11.1 Plant height (cm)

The height of randomly selected ten plants was measured from ground level (stem base) to the tip of the plant at 30 and 50 days after germination (DAS). Mean plant height was calculated and expressed in cm.

3.2.1.11.2 Number of leaves plant⁻¹

Ten plants were collected randomly from each plot. Number of leaves per plant was counted from each plant sample and then averaged at 30 and 50 days after germination (DAS).

3.2.1.11.3 Number of branches plant⁻¹

Ten plants were collected randomly from each plot. Number of branches per plant was counted from each plant sample and then averaged at 30 and 50 days after germination (DAS).

3.2.1.11.4 Days to flowering

The number of days from the date of sowing to the date of 50% flower opening was recorded.

3.2.1.11.5 Days to maturity

The number of days from the date of sowing to the date of 50% physiological mature of the plant was recorded.

3.2.1.11.6 Pod length (cm)

The length of the pod was measured from the base of the pod to the tip of the pod with a slide calipers from the neck of the fruit to the bottom of 20

selected marketable pods from each plot and their average was taken in centimeter as the length of fruit.

3.2.1.11.7 Number of pods plant⁻¹

Total number of pod of ten plants was counted and divided by ten which indicated the number of total pod per plant.

3.2.1.11.8 Number of effective pods plant⁻¹

Effective pod of ten plants was counted and divided by ten which indicated the number of effective pod per plant.

3.2.1.11.9 Number of non-effective pods plant⁻¹

Non effective pod of ten plants was counted and divided by ten which indicated the number of non-effective pod per plant.

3.2.1.11.10 Number of seeds pod⁻¹

Total number of seeds of ten pods was counted and divided by ten which indicated the total number of seeds per pod.

3.2.1.11.11 Number of effective seeds pod⁻¹

Effective seeds of ten pods was counted and divided by ten which indicated the number of effective seeds per pod.

3.2.1.11.12 Number of non-effective seeds pod⁻¹

Non effective seeds of ten pods was counted and divided by ten which indicated the number of non-effective seeds per pod.

3.2.1.11.13 Number of seeds plant⁻¹

Total number of seeds of ten plants was counted and divided by ten which indicated the total number of seeds per plant.

3.2.1.11.14 1000-seeds weight (g)

Thousand seeds were randomly counted from the total seeds of each sample. Then the weight was taken by a digital balance. The 1000-seeds weight was recorded in gram.

3.2.1.11.15 Seed yield (kg ha⁻¹)

The mean grain weight was taken by threshing the plants of each sample area (plot) and then converted to kg ha⁻¹ on dry weight basis.

3.2.1.11.16 Straw yield (kg ha⁻¹)

The straw weights were calculated after threshing and separation of grain from plant of sample area (plot) and then expressed in t ha⁻¹ on dry weight basis.

3.2.1.11.17 Oil content (%)

Oil content of oven dried seeds was estimated by Nuclear Magnetic Resonance (WMR) method against a standard reference sample (AOAC, 1975).

3.2.1.11.18 Oil yield (kg ha⁻¹)

Oil yield of mustard was calculated by using following formula

$$\text{Oil yield (kg ha}^{-1}\text{)} = \frac{\text{Seed oil content (\%)} \times \text{Seed yield (kg ha}^{-1}\text{)}}{100}$$

3.2.1.12 Statistical analysis

The collected data on various parameters were statistically analyzed using MSTAT-C package program. The mean for all the treatment was calculated and analyses of variances of all the characters were performed by F variance test. The significant of difference between the pairs of treatment means was evaluated by the Duncan's Multiple Range Test (DMRT) at 5% and 1% levels of probability (Gomez and Gomez, 1984).

Experiment 2. Effect of sowing time and variety on the yield contributing characters and yield of mustard at research field

The present research work was carried out in the research field of Regional Agricultural Research Station, Khairtala, Jashore in a three years trials from October, 2014 to March, 2017 (1st growing season – October, 2014 to March, 2015, 2nd growing season – October, 2015 to March, 2016 and 3rd growing season – October, 2016 to March, 2017) to investigate the effects of sowing time and variety on the yield contributing characters and yield of mustard (*Brassica sp.*). The procedures used in conducting the experiment have been described below with sub headings.

3.2.2.1 Location of the experimental site

The field experiment was conducted in the research field of Regional Agricultural Research Station, Khairtala, Jashore in the growing season of 2014-2015, 2015-2016 and 2016-2017. The experimental site was located between 23100.120"N latitude and 89130.120"E longitudes at the elevation of 17m above the sea level belonging to the Agro-Ecological Zone (AEZ-11) "High Ganges River Floodplain" (Plate 1).

3.2.2.2 Characteristics of soil

The experimental field was a well-drained medium high land having soil pH 7.17. The analytical data of the soil sample (physical and chemical properties) from the experimental area was determined in the laboratory of Soil Research Institute (SRI), Jashore have been presented in Appendix Table 1.

3.2.2.3 Climate of the experimental site

These were same as mentioned in experiment number 1. The maximum and minimum air temperature, rainfall and relative humidity during the experimental period are shown in appendix table (2-5).

3.2.2.4 Land preparation

The land selected for the experiment was opened 15 days before planting of the crop with a disc plough in the growing season of 2014-2015, 2015-2016 and 2016-2017. It was then thoroughly prepared by ploughing and cross ploughing with a power tiller followed by laddering to obtain good tilth. During land preparation, weeds and stubbles were collected and removed from the field and the clods were broken with the help of hand. The surface of the land was leveled. Finally irrigation and drainage channels were made around the plots. Final land preparation was done one week before sowing.

3.2.2.5 Design and layout of the experiment

The experiment was laid out in two factors Randomized Complete Block Design (RCBD) with three replications. The whole field was divided into three blocks and each block consisted of 12 (twelve) plots. Altogether there were 36 unit plots in the experiment. Each unit plot was 6.0 m² (3.0

m × 2.0 m) in size. The replication was separated from one another by 1m. The distance between plots was 50 cm. The treatment was randomly assigned to each of the block. Each unit plot had 10 rows and each with of a few number of continuous sowing plants. The plants of one row in each unit plot were considered for growth of mustard and other one row were considered for d contributing characters and yield of mustard. Row to row distance was 30 cm and plant to plant distance was continuous and 2-3 cm depth furrows. A layout of the experiment has been shown in Figure 2.

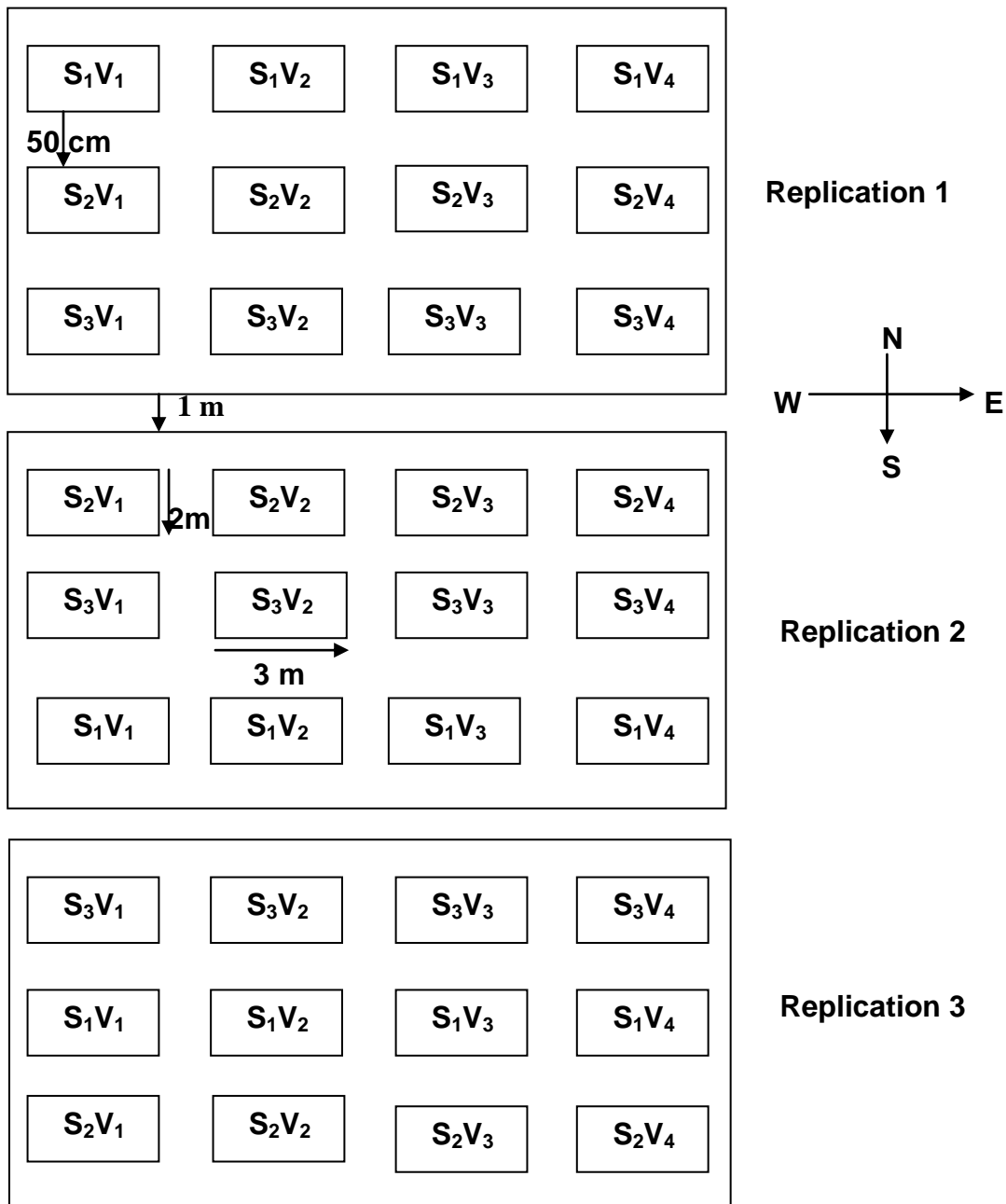

Figure 2. Field layout of the experiment 2 and 3.

Legend: Design: Two Factor Randomized Complete Block Design (RCBD)

Scaling: Vertical & Horizontal: 1 cm = 2m

Factor A: Sowing time: 3

S₁=30thOctober

S₂=10th November

S₃=20th November

Factor B: Variety: 4

V₁=BARI Sarisha 9

V₂=BARI Sarisha 11

V₃=BARI Sarisha 14

V₄=BARI Sarisha 15

Total No. of treatments:

Factor A x Factor B x Replication = 3X4X3=36

Unit plot size: 3m X 2m = 6m²

Spacing: Line to line: 30cm

Plant to plant: Continuous and 2-3 cm
depth furrow

Between plots: 50cm

Between replications: 1m

3.2.2.6 Experimental treatments

The experiment was constructed with two factors viz. factor A (sowing time) with 3 levels and factor B (variety) with 4 levels. The details of the treatment are given below:

Factor A: Sowing time (3 levels) as **Factor B:** Variety (4 levels) as

S₁: 30th October

V₁: BARI Sarisha 9

S₂: 10th November

V₂: BARI Sarisha 11

S₃: 20th November

V₃: BARI Sarisha 14

V₄: BARI Sarisha 15

There were 12 (3×4) treatments combination such as S₁V₁, S₁V₂, S₁V₃, S₁V₄, S₂V₁, S₂V₂, S₂V₃, S₂V₄, S₃V₁, S₃V₂, S₃V₃ and S₃V₄.

3.2.2.7 Manuring and fertilization

Manures and fertilizers were applied as per treatment. NPKS and B were applied in the form of urea, triple super phosphate (TSP), muriate of potash (MOP), gypsum and boric acid, respectively as follows. Cow dung (well decomposed) 10 ton ha⁻¹ and NPKSB as 100-40-50-35-1.5 kg ha⁻¹, respectively (BARC, 1989). The entire quantity of cow dung, TSP, MP, gypsum, boric acid and half of urea were applied at the time of final land preparation. The remaining urea was applied as top dressing in two equal splits at 25 and 50 days after transplanting followed by weeding and irrigation.

3.2.2.8 Sowing of seeds

The seeds of different mustard variety @ 9.0 kg ha⁻¹ were sown on 30th October, 10th November and 20th November as per treatment @ 9.0 kg ha⁻¹ in rows of raised beds in respective growing seasons. Row to row and plant to plant spacing were maintained as 30 cm and continuous and 2-3

cm depth furrows, respectively. The seeds were covered with fine soil by hand.

3.2.2.9 Intercultural operations

The plants were always kept under careful observation. Necessary intercultural operations were done through the cropping season for proper growth and development of the plant as mentioned below was accomplished.

3.2.2.9.1 Weeding, thinning and gap filling

The experimental plots were found to be infested with different kinds of weeds, viz. Bathua (*Chenopodium album* L.), Durba (*Cynodon dactylon*), Nut sedge (*Cyperus rotundus* L.), Biskatali (*Polygonum hydropiper* L.) etc. Weeding was done manually with “nirani” as per treatment. Two hand weeding were done for each treatment; first weeding was done at 15 days after sowing followed by second weeding at 15 days after first weeding. Thinning was done in all the unit plots with care to maintain a constant plant population on each row. Finally plants were kept at 5 cm distance in rows. Gap fillings was done in place of dead or wilted seedlings in the field using healthy seeding of the same stock previously planted in the border area on the same date of transplanting. The soil around the base of each seedling was pulverized after the establishment of seedlings.

3.2.2.9.2 Irrigation

Irrigation was given in the respective plots to ensure puddle soil. First irrigation was given at 15 days after sowing (DAS) and the second irrigation was given at 55 (DAS) following flood method in all the plots.

3.2.2.9.3 Plant protection measure

Crops were attacked by aphids (*Lipaphiserysimi* K). It was controlled by spraying Malathion 57 EC at the rate of 2 ml litre⁻¹ of water. The spraying was done in the afternoon while the pollinating bees were away from the field.

3.2.2.10 Harvesting and processing

These were same as mentioned in experiment number 1.

3.2.2.11 Sampling and data collection procedure

In each treatment from net plot, five plants of mustard were randomly selected and tagged. The observations on growth components at different growth stages and yield components at harvest were recorded. Destructive plant sampling was done with plants selected outside the net plot area.

3.2.2.11.1 Plant height (cm)

The height of randomly selected ten plants was measured from ground level (stem base) to the tip of the plant at 20, 30, 40days after germination (DAS) and at maturity. Mean plant height was calculated and expressed in cm.

3.2.2.11.2 Number of leaves plant⁻¹

Ten plants were collected randomly from each plot. Number of leaves plant⁻¹ was counted from each plant sample and then averaged at 20, 30, 40 days after germination (DAS) and at maturity.

3.2.2.11.3 Number of branches plant⁻¹

Ten plants were collected randomly from each plot. Number of branches per plant was counted from each plant sample and then averaged at 20, 30, 40 days after germination (DAS) and at maturity.

3.2.2.11.4 Days to flowering

The number of days from the date of sowing to the date of 50% flower opening was recorded.

3.2.2.11.5 Days to maturity

The number of days from the date of sowing to the date of 50% physiological mature of the plant was recorded.

3.2.2.11.6 Pod length (cm)

The length of the pod was measured from the base of the pod to the tip of the pod with a slide calipers from the neck of the fruit to the bottom of 20 selected marketable pods from each plot and their average was taken in centimeter as the length of fruit.

3.2.2.11.7 Number of pods plant⁻¹

Total number of pod of ten plants was counted and divided by ten which indicated the number of total pod per plant.

3.2.2.11.8 Number of seeds pod⁻¹

Total number of seeds of ten pods was counted and divided by ten which indicated the total number of seeds per pod.

3.2.2.11.9 Number of seeds plant⁻¹

Total number of seeds of ten plants was counted and divided by ten which indicated the total number of seeds per plant.

3.2.2.11.10 1000- seeds weight (g)

Thousand seeds were randomly counted from the total seeds of each sample. Then the weight was taken by a digital balance. The 1000- seeds weight was recorded in gram.

3.2.2.11.11 Seed yield (kg ha⁻¹)

The mean grain weight was taken by threshing the plants of each sample area (plot) and then converted to kg ha⁻¹ on dry weight basis.

3.2.2.11.12 Straw yield (kg ha⁻¹)

The straw weights were calculated after threshing and separation of grain from plant of sample area (plot) and then expressed in t ha⁻¹ on dry weight basis.

3.2.2.11.13 Oil yield (kg ha⁻¹)

Oil yield of mustard was calculated by using following formula

$$\text{Oil yield (kg ha}^{-1}\text{)} = \frac{\text{Seed oil content (\%)} \times \text{Seed yield (kg ha}^{-1}\text{)}}{100}$$

3.2.2.12 Statistical analysis

The collected data on various parameters were statically analyzed using MSTAT-C package program. The mean for all the treatment was calculated and analyses of variances of all the characters were performed

by F variance test. The significant of difference between the pairs of treatment means was evaluated by the Duncan's Multiple Range Test (DMRT) at 5% and 1% levels of probability (Gomez and Gomez, 1984).

For graphical representation in case of effect of sowing time only the mean values obtained from different treatments against each character were plotted in the graph. Similarly in case of variety, the mean values obtained from the particular variety against each character were used for plotting in the graph.

Experiment 3. Effect of sowing time and variety on the yield contributing characters and yield of mustard at farmer's field

The present research work was carried out in the farmer's field of Village -Karimpur, Thana-Bagharpara, Post-Jamdia, District-Jashore in a three years trials from October, 2014 to March, 2017 (1st growing season – October, 2014 to March, 2015, 2nd growing season – October, 2015 to March, 2016 and 3rd growing season – October, 2016 to March, 2017) to investigate the effects of sowing time and variety on the yield contributing characters and yield of mustard (*Brassica sp.*). The procedures used in conducting the experiment have been described below with sub headings.

3.2.3.1 Location of the experimental site

These were same as mentioned in experiment number 1.

3.2.3.2 Characteristics of soil

These were same as mentioned in experiment number 1.

3.2.3.3 Climate of the experimental site

These were same as mentioned in experiment number 1. The maximum and minimum temperature, rainfall and relative humidity during the experimental period are presented in appendix Table (2-5).

3.2.3.4 Land preparation

These were same as mentioned in experiment number 2.

3.2.3.5 Design and layout of the experiment

These were same as mentioned in experiment number 2.

3.2.3.6 Experimental treatments

These were same as mentioned in experiment number 2.

3.2.3.7 Manuring and fertilization

The land was fertilized with well decomposed cow dung and NPK at the rate of 10 ton and 54-60-15 kg per hectare (Farmers' practice), respectively (BARC, 1989). The sources of NP and K were urea, triple super phosphate (TSP) and muriate of potash (MOP), respectively. The entire quantity of cow dung, TSP, MP and half of urea were applied at the time of final land preparation. The remaining urea was applied as top dressing in two equal splits at 25 and 50 days after transplanting.

3.2.3.8 Sowing of seeds

The seeds of different mustard varieties were sown on 30th October, 10th November and 20th November as per treatment @ 9.0 kg ha⁻¹ following broadcast method in respective growing seasons. The seeds were covered with fine soil by hand.

3.2.3.9 Intercultural operations

The plants were kept under moderate observation. One hand weeding was done and one irrigation was given at 35 DAS. No thinning, gap filling and plant protection measures were taken.

3.2.3.10 Harvesting and processing

These were same as mentioned in experiment number 1 and 2.

3.2.3.11 Sampling and data collection procedure

These were same as mentioned in experiment number 2.

3.2.3.12 Statistical analysis

The collected data on various parameters in the experimental area of different growing season were statically analyzed using MSTAT-C package program. The mean for all the treatment was calculated and analyses of variances of all the characters were performed by F variance test. The significant of difference between the pairs of treatment means was evaluated by the Duncan's Multiple Range Test (DMRT) at 5% and 1% levels of probability (Gomez and Gomez, 1984).

For graphical presentation in case of effect of sowing time only the mean values obtained from different treatments against each character were plotted in the graph. Similarly in case of variety, the mean values obtained from the particular variety against each character were used for plotting in the graph.

3.3 Yield gap analysis and strategies for minimizing the gaps of mustard

The yield gap is defined as difference yield between the maximum attainable yield and the farmer level yield. Yield gap is the difference between the yield of improved variety at the research station and at the farmer's field.

Yield gap of mustard due to the effect of sowing time and variety between research field and farmer's field in the growing seasons of 2014-15, 2015-16 and 2016-17 was calculated by using following formula:

$$\text{Yield gap (\%)} = \frac{IV - FV}{IV} \times 100$$

Where IV=yield at research station and FV= yield at farmers field.

CHAPTER FOUR

RESULTS AND DISCUSSION

In the present study three (03) different experiments were conducted to find out the causes of yield gap and to minimize yield gap of mustard (*Brassica sp.*) through agronomic management techniques. The first experiment was considered as screening and to find out four (04) most potential mustard varieties for the next two experiments. The second experiment was conducted at research field and the third experiment was conducted at farmer's field. After complete these experiments yield gap of mustard was analyzed, which was found between research field and farmer's field in the growing seasons of 2014-15, 2015-16 and 2016-17 and to find out the causes of yield gap and make strategies for minimizing the gaps.

The results obtained from the different experiments are presented and discussed chapter wise under separate heads as follows:

Experiment 4.1 Effect of variety on the yield contributing characters and yield of mustard

The results obtained from experiment 4.1 are presented in tables (1-4). For each character data were collected at 30 and 50 days after sowing (DAS) and at harvesting time in the growing season of 2013-2014. In this experiment seven (07) promising varieties of mustard were used as varietal trial.

4.1.1 Plant height, number of leaves plant⁻¹ and number of branches plant⁻¹

Plant height was significantly changed by variety at 30 and 50 days after sowing (DAS). The tallest plants were found from variety V₃ (89.00 and 110.00 cm) both at 30 and 50 DAS which were significantly different

from all other treatments (Table 1), whereas V_1 produced the shortest plants (50.50 and 68.00 cm) both at 30 and 50 DAS which were also significantly distant from other treatments.

The highest number of leaves plant⁻¹ in 30 DAS was observed in V_6 (22.50) which was statistically identical with V_2 , V_3 , V_5 , V_7 and the lowest was observed in V_4 (11.50) which was statistically similar with V_1 and V_2 . In 50 DAS the highest number of leaves plant⁻¹ was found in V_2 (27.80) which were statistically similar with all other treatments except V_4 . Any other way, the lowest number of leaves plant⁻¹ was observed in V_4 (18.20) which were significantly different from all other treatments (Table 1).

Number of branches plant⁻¹ was found non-significant both in 30 and 50 DAS. These results are more or less similar with the results of Mondal *et al.* (1992) in which they found that variety had significant effect on plant height. These results are in similar with the results of Mondal and Islam (1993) in which they reported that variety had significant effect on plant height. They found the highest plant height (134.4 cm) on the variety J-5004, which was identical with SS-75 and was significantly taller than JS-72 and Tori 7. These results are similar with the result of Hossain *et al.* (1996) in which they stated that highest number of primary branches was recorded in the Hyola-401(5.0) and the lowest number was recorded in semu-249/84. As a result of also in similar with the results of BARI (2000) in which they reported that under poor management the number of branch plant⁻¹ was higher (4.2) in the variety SS-75 and lower (2.1) in the variety BARI Sarisha 8. Under medium management, best performance was Dhali (5.5) and worst performance was BARI Sarisha 8. Under higher management, highest was in Dhali (5.9) and lowest was in (3.0) Nap-248.

Table 1. Effect of variety on the growth of mustard at different days after sowing (DAS).

Treatments	Plant height (cm)		Number of leaves plant ⁻¹		Number of branches plant ⁻¹	
	30 DAS	50 DAS	30 DAS	50 DAS	30 DAS	50 DAS
V ₁ (Tori 7)	50.50d	68.00e	12.20bc	20.20ab	3.00	6.20
V ₂ (BARI Sarisha 9)	67.80c	92.00b-d	19.20a-c	27.80a	5.00	9.50
V ₃ (BARI Sarisha 11)	89.00a	110.00a	20.00ab	25.00ab	4.90	8.70
V ₄ (BARI Sarisha 13)	62.00c	82.00d	11.50c	18.20b	3.90	7.20
V ₅ (BARI Sarisha 14)	65.00c	83.00cd	21.00a	26.70a	4.50	6.90
V ₆ (BARI Sarisha 15)	80.50b	98.00b	22.50a	27.20a	6.00	10.00
V ₇ (BARI Sarisha 16)	78.20b	96.00bc	21.00a	26.50a	4.10	7.50
LS	**	**	**	*	NS	NS
CV (%)	3.96	5.62	17.08	11.78	40.04	32.27
LSD (5%)	6.94	12.59	7.75	7.19	4.48	6.44

Means followed by the same letter (s) do not statistically differ at 5% level tested by DMRT. Here, *and ** indicate significant effect at 5% and 1% level of probability respectively. NS = Non-significant.

4.1.2 Number of pods plant⁻¹ and seeds pod⁻¹

Number of pods plant⁻¹ differed significantly for varieties. Table 2 shows that maximum number of pods plant⁻¹, number of effective pods plant⁻¹ and number of non-effective pods plant⁻¹ (110.00, 102.00 and 8.00) were found in variety V₃ and the minimum pods plant⁻¹ and effective pods plant⁻¹ were found in V₁ but the minimum non- effective pods plant⁻¹ (4.00) was found in V₂ which was statistically different from other treatments. The highest number of seeds pod⁻¹ and effective seeds pod⁻¹ were found (27.00 and 25.00) in V₄ but highest number of non-effective seeds pod⁻¹ (6.50) was found in V₂ which was statistically similar with all other treatments except V₄ (Table 2). Variety V₁ produced the lowest number of seeds pod⁻¹ and effective seeds pod⁻¹ (10.00 and 6.00) which was significantly distant from all other treatments but V₄ produced the lowest number of non-effective seeds pod⁻¹. These results are more or less similar with the result of Jahan and Zakaria (1997) in which they

reported that in case of number of pods plant⁻¹, the highest number was recorded in BLN-900 (130.9) which was identical to Dhali (126.3). Tori 7 had the lowest (46.3) number of pods plant⁻¹. This result is also similar with the result of Mondal *et al.* (1992) in which they stated that highest number of pods plant⁻¹ (136) was found in the variety J-5004, which was identical with the variety Tori 7. The lowest number of pods plant⁻¹ (45.9) was found in the variety SS-75. These results are in agreement with the result of Hossain *et al.* (1996) which they stated that there were significant differences among the varieties with respect to number of seeds pod⁻¹. The highest number of seeds pod⁻¹ was produce in the hybrid BLN-900 (29.5) and the lowest number was recorded in Tori 7 as well as in Semu-249/84. This result is similar with the result of Mondal *et al.* (1992) which they described that the highest number of seeds pod⁻¹ (27.6) in SS-75 which was significantly distant from all other varieties. The lowest number of seeds pod⁻¹ (13.8) was found in J-5004.

Table 2. Effect of variety on number of pods plant⁻¹ and seeds pod⁻¹ of mustard.

Treatments	Number of pods plant ⁻¹					
	Pods plant ⁻¹	Effective pods plant ⁻¹	Non-effective pods plant ⁻¹	Seeds pod ⁻¹	Effective seeds pod ⁻¹	Non- effective seeds pod ⁻¹
V ₁ (Tori 7)	55.00d	48.00d	7.00ab	10.00d	6.00d	4.00ab
V ₂ (BARI Sarisha 9)	92.00b	88.00ab	4.00d	18.50c	12.00cd	6.50a
V ₃ (BARI Sarisha 11)	110.00a	102.00a	8.00a	13.80d	10.00cd	3.80ab
V ₄ (BARI Sarisha 13)	62.00d	55.50cd	6.50a-c	27.00a	25.00a	2.00b
V ₅ (BARI Sarisha 14)	98.00b	92.50ab	5.50b-d	24.20ab	20.00ab	4.20ab
V ₆ (BARI Sarisha 15)	75.67c	70.17bc	6.00bc	20.00bc	16.00bc	4.00ab
V ₇ (BARI Sarisha 16)	62.00d	57.00cd	5.00cd	26.00a	20.20ab	5.80ab
LS	**	**	**	**	**	**
CV (%)	5.60	13.42	11.50	9.36	18.82	31.98
LSD (5%)	11.06	23.90	1.72	4.65	7.32	3.45

Means followed by the same letter (s) do not statistically differ at 5% level tested by DMRT. Here, *and ** indicate significant effect at 5% and 1% level of probability respectively.

4.1.3 Yield contributing characters

The pod length of mustard was measured at the maturity stages before harvesting. The highest pod length was recorded in BARI Sarisha 9 (5.80 cm) which was significantly different from all other treatments and the lowest was in Tori 7 (4.00 cm) which was also significantly different from all other treatments (Table 3). Number of seeds plant⁻¹ was significantly influenced by variety. Number of seeds plant⁻¹ was recorded through counting the seeds per pod. The highest seed contained per plant was recorded in BARI Sarisha 14 (2372.00) and the lowest was in Tori 7 (550.00) in the study period which was significantly different from all other treatments. Table 3 shows that BARI Sarisha 11 produced the highest 1000- seeds weight (3.80 g) which was statistically similar with all other treatments except Tori 7 and the lowest was found (2.60 g) in Tori 7 which was statistically similar with other treatments except V₃, V₄ and V₅.

Highest days required for flowering and maturity were recorded in BARI 11(51.33 and 105.20) which were significantly different from all other treatments except V₂, V₄, V₆ and V₇. The lowest days required for flowering and maturity were found in BARI 14 (35.80 and 76.00) which were statistically similar with V₁, V₂ and V₅ (Table 3).

These results are in agreement with the results of Mondal and Wahab (2001) in which they observed that 1000-seeds weight was 2.5-2.65g in improved Tori 7 (*B. campestris*) and 1.5-7.8g in Rai 5 (*B. juncea*). These results are also similar with the results of BARI (2001) which they achieved that there was significant variation in 1000-seeds weight of mustard found in different varieties and highest weight of 1000-seeds was found in Jamalpur-1 variety and lowest in BARI Sarisha 10. This findings are similar with the findings of Hussain *et al.* (1998) which they observed

significant variation in case of 1000-seeds weight as influenced by different varieties. They found that Hyda-401 had the highest 1000- seeds weight (3.4g) and the lowest 1000-seeds weight was recorded in Tori 7 (2.1g).

Maturity was significantly influenced by variety. The results have been presented in (Table 3). Between the different varieties the highest maturity was recorded in BARI Sarisha 11(105.20) and the lowest was in BARI Sarisha 14 (76.00) during the study period. The results of similar with Raquibullah *et al.* (2006) where they conducted a field experiment at the Central Research Station of BARI, Joydebpur, Gazipur, Bangladesh for two consecutive years (1998-99 and 1999-2000) with *B. campestris* (cultivars Tori 7, TS-72, SS-75, BARI Sarisha 6, BARI Sarisha 9 and BARI Sarisha 12), *B. juncea* (cultivars Rai-5, Daulat, BARI Sarisha 10 and BARI Sarisha 11), and *B. napus* (cultivars BARI Sarisha 7, BARI Sarisha 8 and Nap 248) and three sowing dates, viz., 20 October, 11 November and 5 December to study the performance of rapeseed-mustard cultivars for early and late sowing situation. They observed that variety has significantly influenced plant height, siliqua plant⁻¹, seeds siliqua⁻¹, seed yield, stover dry weight, Days to 50% flowering, maturity and oil content of seed in both the years. Maturity was different among the different varieties during the growing season of the experimental area.

4.1.4 Yield

Seed yield was significantly influenced by variety. The results have been presented in (Table 4).The highest seed yield (2320.00 kg ha⁻¹) was observed in V₃ (BARI Sarisha 11) which was statistically similar with V₄ and the lowest (950.00 kg ha⁻¹) was found in V₁ which was statistically different from all other treatments except V₂.

Table 3. Effect of variety on yield contributing characters of mustard.

Treatments	Pod length (cm)	Number of seeds plant ⁻¹	1000-seeds weight (g)	Days to flowering	Days to maturity
V ₁ (Tori 7)	4.00f	550.00c	2.60b	39.20bc	77.20cd
V ₂ (BARI Sarisha 9)	5.80a	1702.00b	2.90ab	45.00a-c	82.50cd
V ₃ (BARI Sarisha 11)	5.00c	1518.00b	3.80a	51.33a	105.20a
V ₄ (BARI Sarisha 13)	4.60bd	1674.00b	3.60a	48.20ab	92.00b
V ₅ (BARI Sarisha 14)	5.20b	2372.00a	3.75a	35.80c	76.00d
V ₆ (BARI Sarisha 15)	5.00c	1520.00b	3.10ab	44.20a-c	81.00cd
V ₇ (BARI Sarisha 16)	4.20e	1612.00b	3.00ab	46.00ab	84.00c
LS	**	**	*	**	**
CV (%)	18.55	10.09	15.12	8.46	3.10
LSD (5%)	0.11	9.45	0.87	9.33	6.59

Means followed by the same letter (s) do not statistically differ at 5% level tested by DMRT. Here, *and ** indicate significant effect at 5% and 1% level of probability respectively.

Table 4 shows that maximum straw yield (2830.00 kg ha⁻¹) was found in V₃ which was statistically similar with V₄ and V₇. The minimum straw yield was observed in V₁ (1330.00 kg ha⁻¹) which was statistically different from all other treatments.

The maximum oil content and oil yield (43.30% and 405.00 kg ha⁻¹) were observed in V₂ which were statistically similar all other treatments except V₁. On the other hand, the minimum oil content and oil yield (33.20% and 206.40 kg ha⁻¹) were found in V₁ which were statistically different from all other treatments (Table 4).

This result is similar to the result of Rahman (2002) where he observed that the highest seed yield in BARI Sharisha 7, BARI Sarisha 8 and BARI Sarisha 11(2.00-2.50 kg ha⁻¹) and the lowest yield in variety Tori 7 (0.95-1.10 kg ha⁻¹). This finding is also similar with the findings of BARI (2001) in which he showed that seed yield and other yield contributing characters significantly varied among the varieties.

On the basis of growth characters, duration and yield performance from experiment-4.1, 04 (four) varieties of mustard were selected viz. V₂-BARI Sharisha 9, V₃-BARI Sharisha 11, V₅-BARI Sharisha 14 and V₆-BARI Sharisha 15 for next two experiments.

Table 4. Effect of variety on the yield of mustard.

Treatments	Seed yield (kg ha ⁻¹)	Straw yield (kg ha ⁻¹)	Oil content (%)	Oil yield (kg ha ⁻¹)
V ₁ (Tori 7)	950.00c	1330.00d	33.20b	206.40b
V ₂ (BARI Sarisha 9)	1350.00bc	2420.00bc	43.30a	405.00a
V ₃ (BARI Sarisha 11)	2320.00a	2830.00a	40.50ba	400.00a
V ₄ (BARI Sarisha 13)	2200.00a	2700.00ab	42.10a	380.00a
V ₅ (BARI Sarisha 14)	1520.00b	2100.00c	40.80a	398.00a
V ₆ (BARI Sarisha 15)	1600.00b	2130.00c	40.23a	360.00a
V ₇ (BARI Sarisha 16)	1700.00b	2750.00ab	41.20a	390.00a
LS	**	**	**	*
CV (%)	10.10	8.26	6.76	20.78
LSD (5%)	418.90	340.70	6.77	134.10

Means followed by the same letter (s) do not statistically differ at 5% level tested by DMRT. Here, *and ** indicate significant effect at 5% and 1% level of probability respectively.

Experiment 4.2 Effect of sowing time and variety on the yield contributing characters and yield of mustard at research field.

This experiment was conducted at research field during the growing seasons of 2014-2015, 2015-2016 and 2016-2017 with and 03 (three) different sowing times and 04 (four) different varieties of mustard selected from experiment 4.1. For each character data were collected at 20, 30 and 40 days after sowing (DAS) and at harvesting time. The results of the present experiment are shown in tables 5 to 17 and figures 3 to 28 which have been described below with sub heading as follows:

4.2.1 Plant height (cm)

The plant height of mustard induced by different treatments was recorded at 20, 30 and 40 days after sowing and at harvesting time in three different growing seasons. The values are illustrated in Table 5 and Figures 3-4. At 20 DAS the maximum plant height (17.33 cm, 16.33 cm and 16.33 cm) were observed in treatments S_1V_2 and S_2V_2 in three different growing seasons and the lowest (11.00 cm, 11.67 cm and 11.67 cm) were found in treatments S_2V_4 , S_2V_1 and S_2V_3 in 1st, 2nd and 3rd growing seasons which were significantly different from all other treatments (Table 5).

In 03 (three) different growing seasons at 30 DAS treatments S_1V_2 produced the maximum plant height of 38.67 cm, 37.00 cm and 36.33cm whereas the minimum plant height (26.00 cm, 26.67 cm and 27.33cm) was produced by treatments S_3V_1 and S_2V_1 .

At 40 DAS the higher plant (75.22 cm) was found in the treatment S_1V_2 which was statistically similar with S_2V_2 and the lowest (48.44 cm) was observed in S_3V_4 which was statistically identical with all other treatments except S_1V_2 , S_2V_2 and S_3V_2 in the growing season of 2014-2015. In the growing seasons of 2015-2016 and 2016-2017 the highest plant heights (73.33 cm and 72.67 cm) were observed in treatments S_3V_2 and the lowest (48.00 cm and 47.67 cm) were found in S_3V_4 and S_2V_3 .

At maturity of mustard, in the growing seasons of 2014-2015, 2015-2016 and 2016-2017 the longest plants (106.0 cm, 106.00 cm and 104.7 cm) were found in treatments S_2V_2 , S_1V_2 and S_3V_2 which were significantly different from all other treatments. On the other hand, the shortest plants (70.00 cm, 75.00 cm and 73.33 cm) were observed in S_3V_3 and S_2V_1 .

Figure 3 indicates that among three different sowing times treatment S_1 produced the tallest plant at 20 DAS in the growing seasons of 2014-2015 and 2015-2016 but in 2016-2017, it was produced by S_3 . On the other hand, the lowest one was found in S_3 , S_2 and S_1 in the three different growing seasons. At 30 DAS treatment S_1 and S_2 (2016-2017) produced the highest plant height and lowest plant height was found in treatments S_3 (2014-2015), S_2 (2015-2016) and S_1 (2016-2017).

At 40 DAS treatment S_2 produced the tallest plant whereas treatment S_3 produced the shortest plants in all three growing seasons. At maturity treatment S_2 produced the tallest plants and treatment S_3 produced the lowest plant height in all three growing seasons.

Among four different varieties, V_2 (BARI Sharisha 11) produced the tallest plant both at 20, 30, 40 DAS and at maturity in all the three growing seasons. The shortest plant was found in treatment V_1 at 20 and

30 DAS in 2014-2015, 30 DAS in 2015-2016 and 2016-2017. Treatment V₃ produced the shortest plant in 20 and 40 DAS in the growing season of 2016-2017. Additionally treatment V₄ produced the shortest plant at 40 DAS in 2014-2015 and at 20 and 40 DAS in 2015-2016. At maturity treatment V₂ produced the highest plant height and treatment V₃ produced the shortest plants in all three growing seasons (Figure 4).

These results are more or less similar with the results of Mondal *et al.* (1992) which they observed that variety had significant effect on plant height. This result is also identical with the result of Ali *et al.* (1986) which they observed significant variation in plant height in different varieties of mustard and rape. Results are in agreement with the results of Mondal and Islam (1993) which they reported that variety had significant effect on plant height. They found the highest plant height (134.4 cm) on the variety J-5004, which was identical with SS-75 and was significantly taller than JS-72 and Tori 7.

These results are more or less similar with the results of Majumder and Sandhu (1964) and sing *et al.* (1972) which they noted that the time of sowing had a significant effect on yield of mustard. Thurling (1974 a) reported that the flowering time in *B. napus* was short with successive delay in sowing but the time taken in *B. campestris* was longer with middle sowing than early and late sowing.

Table 5. Combined effect of sowing time and variety on plant height (cm) of mustard at different days after sowing in three growing seasons at research field.

Treatments		Plant height (cm)											
		2014-2015				2015-2016				2016-2017			
Sowing time	Variety	20 DAS	30 DAS	40 DAS	At maturity	20 DAS	30 DAS	40 DAS	At maturity	20 DAS	30 DAS	40 DAS	At maturity
S ₁	V ₁	12.67bc	28.17cde	51.28bc	77.67e	13.17 b	27.33c-e	50.67 c	77.00 c	13.00 de	29.33 b	51.00 c	77.00 c
	V ₂	17.33 a	38.67 a	75.22 a	106.0a	16.33 a	37.00 a	70.67 a	106.0 a	16.00 ab	36.33 a	69.33ab	104.0 a
	V ₃	13.17 b	30.67 bc	51.55bc	81.00c	12.67 b	29.33b-d	52.00 c	81.33 b	12.67 de	30.00 b	49.00 c	82.00 b
	V ₄	12.50bc	31.17 b	50.11 c	85.33b	12.33 b	30.67 b	49.67 c	84.67 b	12.33 de	29.33 b	49.67 c	84.00 b
S ₂	V ₁	11.50bc	27.67 de	54.78 b	77.33e	11.67 b	27.00 de	61.67 b	75.00 c	12.33 de	27.33 b	61.00 b	73.33 c
	V ₂	16.67 a	37.83 a	74.55 a	105.7a	16.33 a	36.67 a	72.67 a	105.3 a	16.33 a	35.00 a	72.00 a	102.0 a
	V ₃	13.00 b	29.17bcd	50.22 c	80.33cd	12.33 b	28.33b-e	49.67 c	81.33 b	11.67 e	27.67 b	47.67 c	82.00 b
	V ₄	11.00 c	30.67 bc	52.55bc	84.67b	11.67 b	29.67 bc	49.67 c	85.00 b	14.00b-d	30.33 b	50.00 c	84.00 b
S ₃	V ₁	11.50bc	26.00 e	49.78 c	78.00e	12.00 b	26.67 e	48.67 c	76.00 c	13.00 de	27.33 b	48.00 c	74.00 c
	V ₂	16.00 a	37.33 a	74.13 a	105.3a	15.67 a	37.00 a	73.33 a	104.0 a	15.33a-c	35.00 a	72.67 a	104.7a
	V ₃	11.67bc	29.33b-d	49.44 c	79.67d	12.67 b	30.33 b	49.33 c	82.00 b	13.67c-e	30.00 b	49.00 c	81.00 b
	V ₄	12.67bc	28.00c-e	48.44 c	84.67b	12.33 b	29.00b-e	48.00 c	82.67 b	12.67 de	28.00 b	48.67 c	82.00 b
LS		*	**	*	*	*	*	*	*	*	*	*	*
CV (%)		7.61	4.59	3.74	1.761	6.83	4.31	7.49	3.762	9.26	6.10	9.49	3.835
LSD (5%)		0.840	1.593	1.761	3.7 4	0.767	1.123	3.572	2.56	1.065	1.573	4.473	2.64

Means followed by the same letter (s) do not statistically differ at 5% level tested by DMRT. Here, *and ** indicate significant effect at 5% and 1% level of probability respectively. NS = Non-significant.

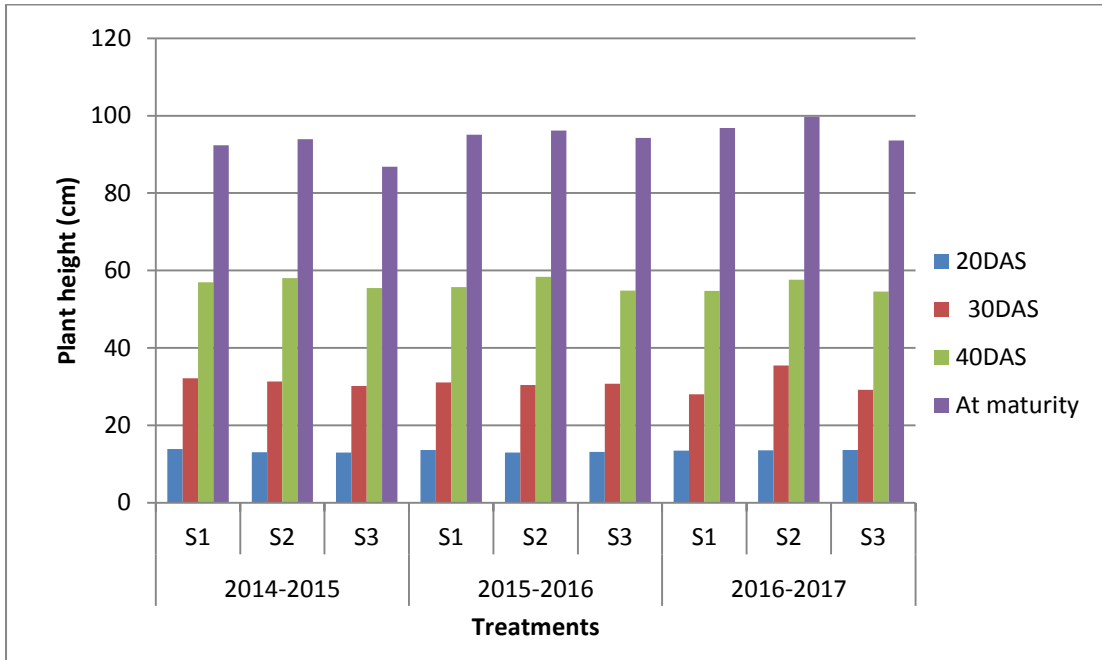

Figure 3. Effect of sowing time on plant height (cm) of mustard at different days after sowing in the growing seasons of 2014-2015, 2015-2016 and 2016-2017 in research field.

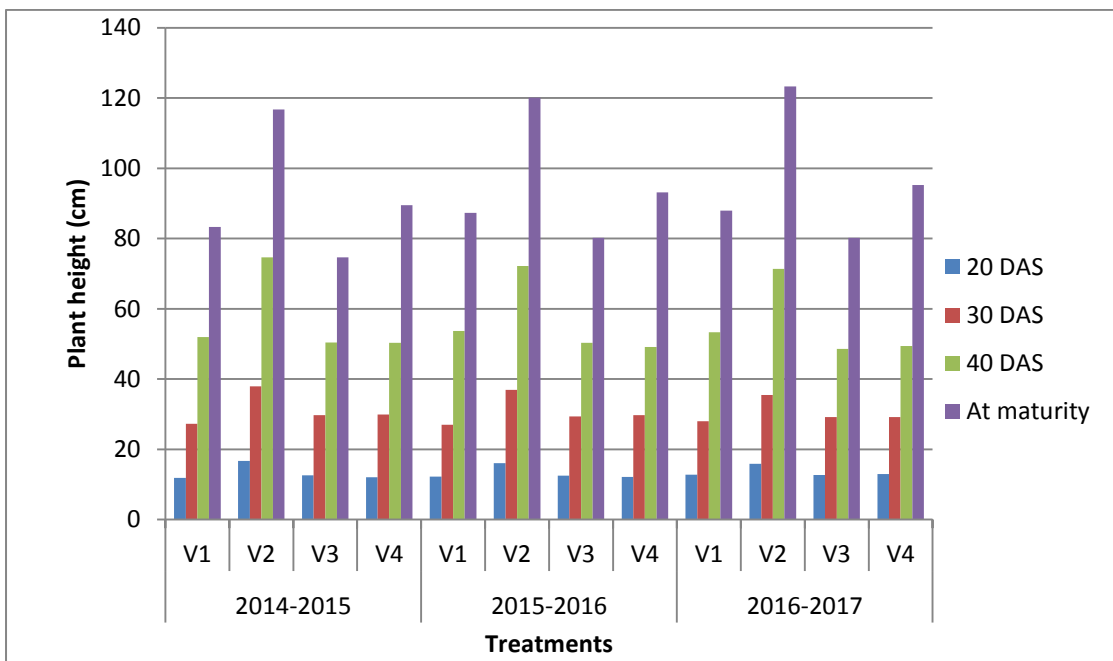

Figure 4. Effect of variety on plant height (cm) of mustard at different days after sowing in the growing seasons of 2014-2015, 2015-2016 and 2016-2017 in research field.

4.2.2 Number of leaves plant⁻¹

Number of leaves plant⁻¹ of mustard induced by different treatments was recorded at 20, 30 and 40 days after sowing and at harvesting time in three different growing seasons. The values are illustrated in Table 6 and Figures 5-6. At 20 DAS the maximum number of leaves plant⁻¹ (11.85, 15.00 and 15.20) were observed in treatments S₁V₃, S₂V₂ and S₂V₃ in three different growing seasons and the lowest (7.78, 10.20 and 10.10) were found in treatments S₃V₄, S₁V₂ and S₁V₄ in 1st, 2nd and 3rd growing seasons which were significantly different from all other treatments.

In 03(three) different growing seasons at 30 DAS treatments S₁V₃ and S₂V₂ produced the maximum number of leaves plant⁻¹ of 19.07, 24.10 and 22.07 whereas the minimum leaves plant⁻¹ (12.25, 15.24 and 16.17) were produced by treatments S₃V₃ and S₃V₄.

At 40 DAS the highest number of leaves plant⁻¹ (31.25, 33.50 and 33.80) were found in the treatment S₃V₂ and S₂V₂, whereas the lowest leaves plant⁻¹ (22.87, 25.10 and 24.00) was observed in S₁V₄, S₃V₃ and S₃V₄ in the growing season of 2014-2015, 2015-2016 and 2016-2017 which were significantly different from all other treatments.

At maturity of mustard, in the growing season of 2014-2015 the highest number of leaves plant⁻¹ was found (30.00) in S₂V₂ which was statistically identical with all other treatments except S₁V₁, S₁V₄ and S₃V₄ and the lowest was observed in (22.00) S₁V₄ which was statistically identical with S₁V₁ and S₃V₄ (Table 6). In the growing season of 2015-2016, the maximum leaves plant⁻¹ was (34.03) was produced by treatment S₂V₂ and the lowest (27.25) was in S₃V₃ which were statistically different from all other treatments. The highest number of leaves plant⁻¹ was (32.10) was

observed in treatment S_2V_2 followed S_1V_2 , S_2V_4 and S_3V_2 and the lowest (25.80) was in S_3V_3 which was statistically similar with S_1V_1 , S_1V_4 , S_2V_1 , S_2V_3 , S_3V_1 , S_3V_3 and S_3V_4 in the growing season of 2015-2016.

Number of leaves plant⁻¹ was significantly influenced by different sowing time. The results have been presented in Figure 5. Among different growing seasons and different DAS the highest number of leaves plant⁻¹ was recorded in S_2 of 40 DAS in the growing seasons of 2015-16 which was identical with 30th October sowing and then decreased progressively and the lowest was recorded in 20th November in 20 DAS in the growing season of 2014-15. At maturity treatment S_1 and S_2 formed the highest number of leaves plant⁻¹ in the growing season of 2015-16 and the lowest was in S_1 in the growing season of 2014-15.

Among four different varieties, V_2 (BARI Sharisha 11) produced the maximum number leaves plant⁻¹ both 30 and 40 DAS in growing season 2014-2015 and 2015-2016. Treatment V_2 produced the maximum leaves plant⁻¹ at 30 and 40 DAS in 2016-2017. The minimum number leaves plant⁻¹ was found in treatment V_4 at 20 and 30 DAS in 2014-2015, 20 DAS at 2015-2016 and 2016-2017. Additionally treatment V_1 and V_2 produced the minimum number leaves plant⁻¹ at 20 DAS in 2014-2015 and 20 DAS in 2015-2016 and 2016-2017 during the study period. At maturity treatment V_2 produced the maximum number leaves plant⁻¹ and treatment V_4 produced the minimum number leaves plant⁻¹ in all three growing seasons (Figure 6). These results are more or less identical to the results of Islam *et al.* (1994) which they reported that delay in planting suppressed the number of leaves plant⁻¹. Hossain *et al.* (1996) stated that highest number of primary branches was recorded in the Hyola-401(5.0) and the lowest number was recorded in semu-249/84.

Table 6. Combined effect of sowing time and variety on number of leaves plant⁻¹ of mustard at different days after sowing in three growing seasons at research field.

Treatments		Number of leaves plant ⁻¹											
		2014-2015				2015-2016				2016-2017			
Sowing time	Variety	20 DAS	30 DAS	40 DAS	At maturity	20 DAS	30 DAS	40 DAS	At maturity	20 DAS	30 DAS	40 DAS	At maturity
S ₁	V ₁	9.80 cd	14.77 de	23.27 d	24.00 b-d	12.20 b	17.50ef	27.00 ef	28.90 f	11.40bc	18.17 a-c	25.03 ef	26.25 d
	V ₂	10.25b-d	16.85bc	28.25 b-c	27.27 a-c	10.20 ef	22.10a-c	33.00 a	34.03 a	12.77a-c	20.07 a-c	30.17 bc	30.52 ab
	V ₃	11.85a	19.07 a	27.25 bc	29.00 ab	15.00 a	24.10 a	32.93 a	32.10 c	14.00 ab	22.03 a	31.28 ab	29.13 bc
	V ₄	8.27 e	12.95 fg	22.87 d	22.00 d	11.10 de	18.00 e	27.07ef	28.35 g	10.10 c	17.07 bc	25.12 gf	26.26 d
S ₂	V ₁	9.25de	15.75 c-e	26.00 cd	28.15 ab	10.00 f	22.00 b-d	29.10cd	29.20 e	12.00a-c	20.10 a-c	27.20 c-e	27.13 cd
	V ₂	11.27ab	18.00 ab	30.13 ab	30.00 a	15.00 a	22.50 ab	31.80ab	33.10 b	14.13 ab	22.07 a	33.80 a	32.10 a
	V ₃	11.00a-c	17.25 bc	27.80 a-c	28.90 ab	14.10 a	20.00 b-e	32.00 a	29.25 e	15.20 a	20.03 a-c	29.08 b-d	27.12 cd
	V ₄	9.20 de	14.87 de	26.82b-d	28.20 ab	11.20 cd	19.20 de	30.25bc	32.17 c	12.23a-c	18.15 a-c	28.05 c-e	30.18 ab
S ₃	V ₁	8.00 e	16.00 cd	25.15 cd	27.07 a-c	12.00b-d	21.15 b-d	28.20de	30.25d	11.07 bc	19.10 a-c	27.17 c-e	28.16 b-d
	V ₂	7.99 e	14.28 ef	31.25 a	30.00 a	14.20 a	19.25 de	33.50 a	33.10 b	13.20a-c	20.87 ab	32.10 ab	30.00 ab
	V ₃	7.78 e	12.25 g	25.00cd	26.91 a-c	10.20 f	19.62 c-e	25.10 g	27.25 h	11.47 bc	17.00 bc	26.10 def	25.80 d
	V ₄	8.00 e	14.20 ef	23.10d	23.00 cd	12.10 bc	15.24 f	25.80 fg	28.75 f	10.87 bc	16.17 c	24.00 f	26.27 d
LS		*	*	*	*	*	*	*	*	*	*	*	*
CV (%)		3.35			9.43	3.05	6.45	4.56	1.00	9.64	9.98	4.12	7.43
LSD (5%)		1.30	1.47	3.54	4.41	0.86	2.53	1.66	0.25	3.14	3.49	1.39	2.33

Means followed by the same letter (s) do not statistically differ at 5% level tested by DMRT. Here, *and ** indicate significant effect at 5% and 1% level of probability respectively. NS = Non-significant.

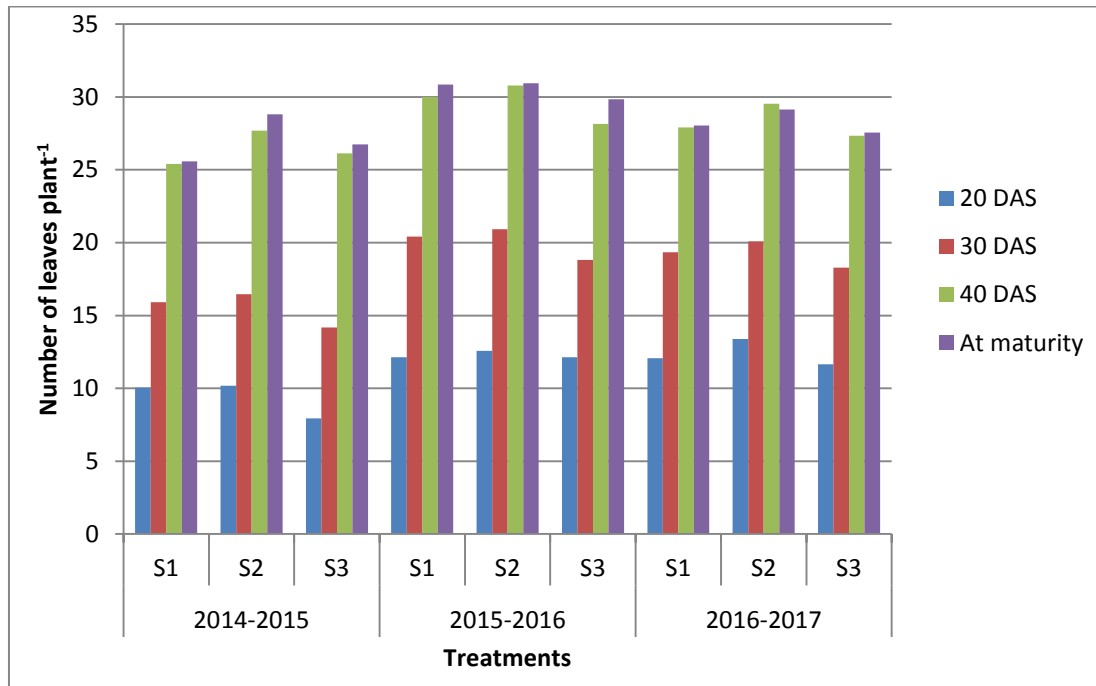

Figure 5. Effect of sowing time on number of leaves plant⁻¹ of mustard at different days after sowing in the growing seasons of 2014-2015, 2015-2016 and 2016-2017 in research field.

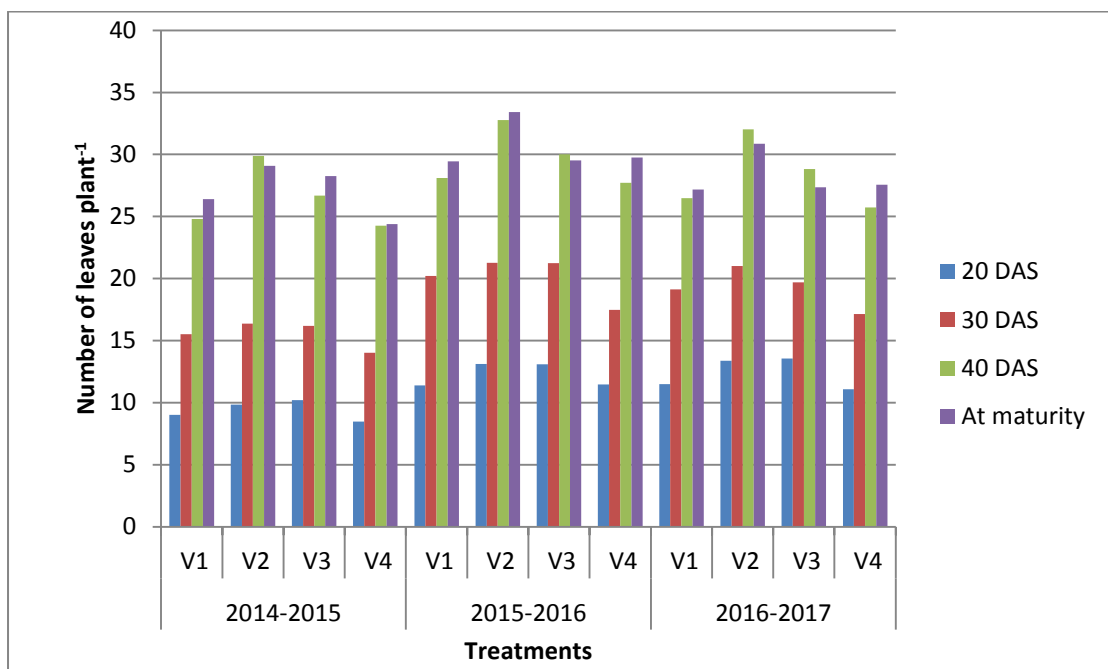

Figure 6. Effect of variety on number of leaves plant⁻¹ of mustard at different days after sowing in the growing seasons of 2014-2015, 2015-2016 and 2016-2017 in research field.

4.2.3 Number of branches plant⁻¹

The number of branches plant⁻¹ of mustard induced by different treatments was recorded at 20, 30 and 40 days after sowing and at harvesting time in three different growing seasons. The values are illustrated in Table 7 and Figures 7-8. Maximum number of branches plant⁻¹ (2.33 , 2.00 and 1.67) were observed in treatments S₁V₃ in three different growing seasons and the minimum (0.67) was found in treatments S₂V₂, S₂V₄, S₃V₂ and S₁V₄ at 20 DAS in 1st, 2nd and 3rd growing seasons which were statistically similar with all other treatments.

In 03 (three) different growing seasons at 30 DAS treatments S₃V₁ produced the highest number of branches plant⁻¹ of 3.67, 3.00 and 3.00 whereas the lowest number of branches plant⁻¹ (1.33, 1.00 and 1.00) was produced by treatments S₁V₃, S₂V₃, S₂V₄ and S₃V₂ which were significantly different from all other treatments.

At 40 DAS the highest number of branches plant⁻¹ (7.67, 7.66 and 7.00) were found in the treatment S₁V₁ and S₂V₁, whereas the lowest number of branches plant⁻¹ (2.33) was observed in S₁V₄, S₂V₂, S₂V₃, S₂V₄, S₃V₂ and S₃V₃ in the growing season of 2014-2015, 2015-2016 and 2016-2017 which were statistically variation from all other treatments.

At maturity of mustard, in the growing seasons of 2014-2015, 2015-2016 and 2016-2017 the maximum number of branches plant⁻¹ (13.33, 13.37 and 12.33) were found in treatment S₁V₁ which were significantly different from all other treatments. On the other hand, the minimum number of branches plant⁻¹ (3.67) were observed in treatments S₁V₄, S₂V₂ and S₂V₃ in the research field of the experimental area which were also statistically different from all other treatments (Table 7).

Figure 7 indicates that number of branches plant⁻¹ was non-significant by different sowing time. In three different growing seasons among 20, 30 and 40 DAS the maximum number of branches plant⁻¹ was recorded in 30th October sowing and the minimum number of branches plant⁻¹ was recorded in 10th November which was statistically identical with all other treatments. At maturity treatment S₁ produced the highest number of branches plant⁻¹ in growing season 2014-2015 and the lowest was in 2016-2017 which were statistically similar with all other treatments.

Number of branches plant⁻¹ of mustard was significantly influenced by variety (Figure 8). Higher number of branches plant⁻¹ was produced by BARI Sharisha 9 at 40DAS in growing season of 2015-2016 and lower number of branches plant⁻¹ was given by BARI Sharisha 11 and BARI Sharisha 15 at 20DAS in growing season 2015-2016 and 2016-2017 among four different varieties in different growing seasons.

These results are more or less similar with the result of Mendham *et al.* (1990) who mentioned that planting too early also reduces seed yield as because of excessive vegetative growth. These results are in similar with the result of BARI (2000) which he found that under poor management the number of branch plant⁻¹ was higher (4.2) in the variety SS-75 and lower (2.1) in the variety BARI Sarisha 8. Under medium management, best performance was Dhali (5.5) and worst performance was BARI Sarisha 8. Under higher management, highest was in Dhali (5.9) and lowest was in (3.0) Nap-248. These results also support the result of Zakaria and Jahan (1997) which they found that the local varieties Tori and Rased formed the highest number of primary branches plant⁻¹ (4.07) which were at par with BLN 900. The minimum number of primary branches plant⁻¹ of 2-90 was found in Jatarai which was identical to those found in Hhole-410 and BARI Sarisha 8 varieties.

Table 7. Combined effect of sowing time and variety on number of branches plant⁻¹ of mustard at different days after sowing in three growing seasons at research field.

Treatments		Number of branches plant ⁻¹											
		2014-2015				2015-2016				2016-2017			
Sowing time	Variety	20 DAS	30 DAS	40 DAS	At maturity	20 DAS	30 DAS	40 DAS	At maturity	20 DAS	30 DAS	40 DAS	At maturity
S ₁	V ₁	1.33 ab	3.33 a	7.67 a	13.33 a	1.67ab	1.66 bc	7.67 a	13.37a	1.33 a	2.33a-c	6.67 a	12.33a
	V ₂	1.33 ab	1.67 b	3.33 c	4.67 cd	1.00 bc	1.33 c	3.33 b	4.33cd	1.33 a	1.67c-e	2.67 b	4.33bc
	V ₃	2.33 a	1.33 b	2.67 c	4.67cd	2.00 a	1.00 c	2.67 b	4.00 d	1.67 a	1.33 de	2.67 b	4.00bc
	V ₄	0.67 b	1.66 b	2.33 c	3.67 d	1.00 bc	1.67bc	2.33 b	3.67 d	0.67 a	1.33 de	2.33 b	3.67c
S ₂	V ₁	1.66 ab	3.33 a	6.33 b	12.67 ab	1.33abc	2.33 ab	6.67 a	12.00ab	1.00 a	2.67ab	7.00 a	11.67a
	V ₂	0.67 b	2.00 b	2.33 c	3.67 d	0.66 c	1.67 bc	2.33 b	3.67 d	0.67 a	2.00b-d	2.33 b	3.67c
	V ₃	1.67 ab	1.33 b	2.33 c	4.33cd	1.66ab	1.33 c	2.33 b	4.00 d	1.67 a	1.66c-e	2.33 b	3.67c
	V ₄	0.66 b	1.33 b	3.00 c	4.67cd	0.67c	1.00 c	2.33 b	4.33 cd	0.67 a	1.00 e	2.66 b	4.33bc
S ₃	V ₁	1.67 ab	3.67 a	6.33 b	12.00 b	1.33a-c	3.00 a	6.67a	11.33 b	1.00 a	3.00 a	6.33 a	11.00a
	V ₂	0.67 b	1.33 b	2.33 c	4.00 d	1.00 bc	1.33 c	2.33 b	4.00 d	0.67 a	1.00 e	2.33 b	4.00bc
	V ₃	1.67 ab	2.00 b	3.00 c	5.333c	2.00a	1.67 bc	2.33 b	5.67 c	1.67 a	2.00b-d	2.33 b	5.33b
	V ₄	1.67 ab	1.66 b	3.00 c	4.00 d	1.66 ab	1.33 c	2.67 b	3.67 d	1.33 a	1.33 de	2.67 b	4.00bc
LS		*	*	*	*	*	*	*	*	*	*	*	*
CV (%)		9.84	16.81	10.42	12.24	37.30	20.11	10.28	14.43	13.80	18.74	18.18	20.45
LSD (5%)		0.97	1.04	1.04	1.132	0.76	0.99	1.29	1.41	0.92	0.99	1.19	1.50

Means followed by the same letter (s) do not statistically differ at 5% level tested by DMRT. Here, *and ** indicate significant effect at 5% and 1% level of probability respectively. NS = Non-significant.

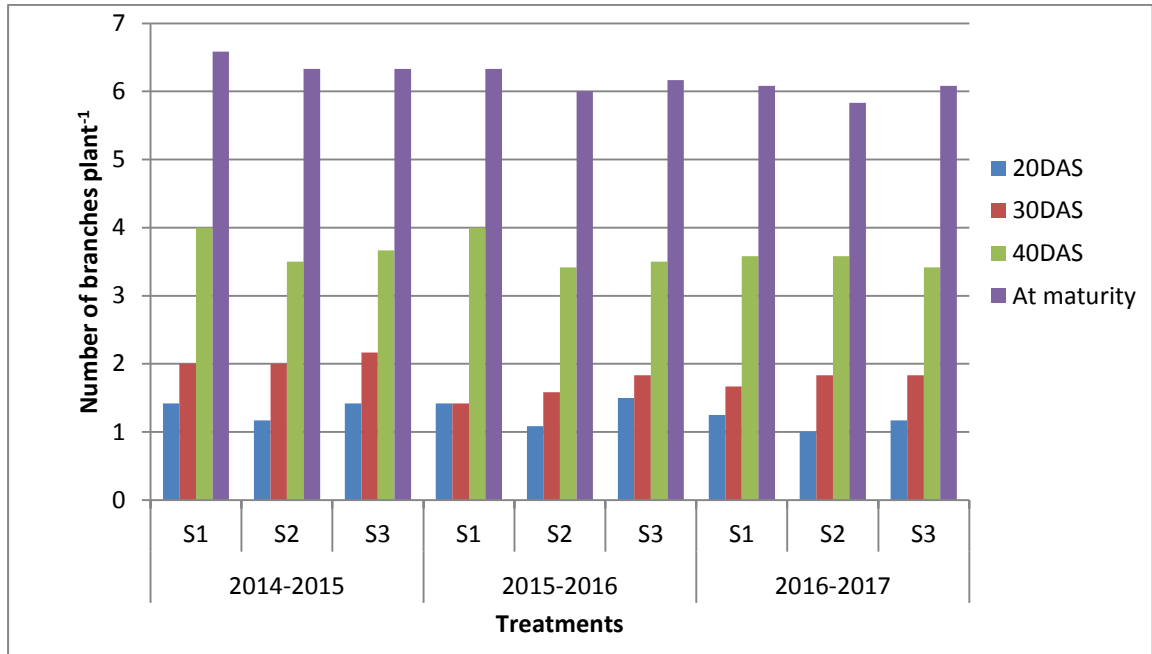

Figure 7. Effect of sowing time on the number of branches plant⁻¹ of mustard at different days after sowing in the growing seasons of 2014-2015, 2015-2016 and 2016-2017 in research field.

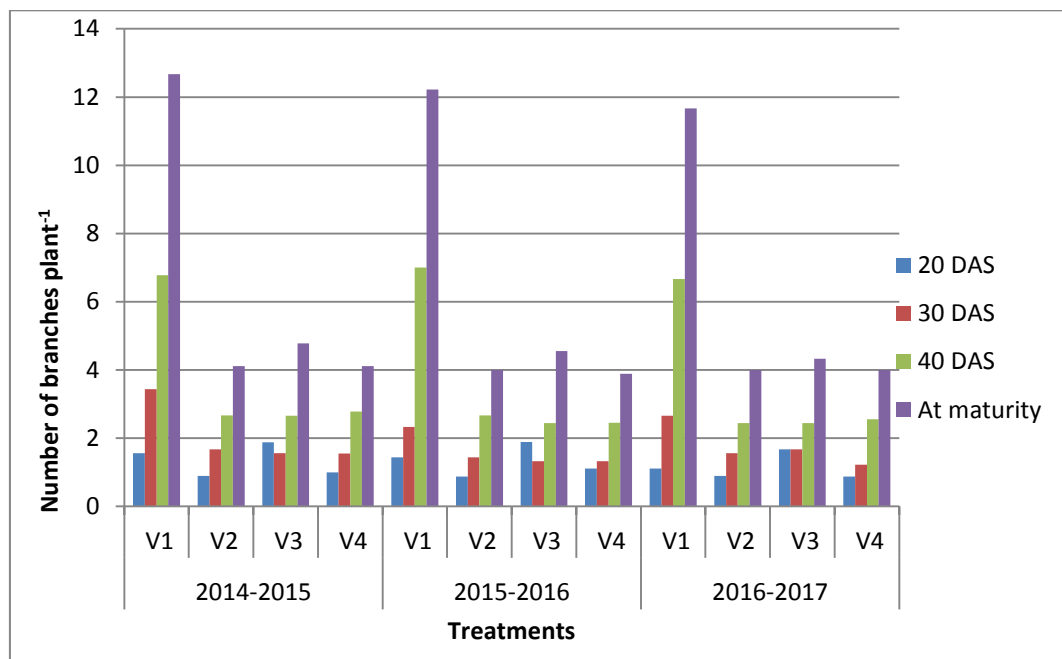

Figure 8. Effect of variety on the number of branches plant⁻¹ of mustard at different days after sowing in the growing seasons of 2014-2015, 2015-2016 and 2016-2017 in research field.

4.2.4 Days to 50% flowering

The combined effect of sowing time and variety in relation to 50% flowering of mustard was recorded in three different growing seasons. The values are illustrated in Table 8 and Figures 9-10. Treatment S_2V_2 required maximum days (44.67) for 50% flowering which was statistically similar with treatments S_1V_2 and S_3V_2 whereas the treatments S_1V_1 , S_2V_1 and S_3V_1 required the minimum days (29.67) which were significantly different from all other treatments in the growing season of 2014-2015 (Table 8).

In the growing seasons of 2015-2016 and 2016-2017 treatment S_3V_2 required the maximum days for 50% flowering (42.67) and treatment S_3V_1 required the minimum days (29.00 and 28.67) which were significantly different from all other treatments.

Figure 9 showed that among three different sowing time treatment S_1 required the maximum days for 50% flowering which has statistically non-significant and treatment S_3 required the minimum days in the growing seasons of 2014-2015, 2015-2016 and 2016-2017.

In case of different variety treatment V_2 required the maximum days for 50% flowering whereas treatment V_1 required the minimum days which were significantly different from all other treatments in all three growing seasons (Figure 10).

These results are more or less similar with the results of Raquibullah *et al.* (2006) where they conducted a field experiment at the Central Research Station of BARI, Joydebpur, Gazipur, Bangladesh, for two consecutive years (1998-99 and 1999-2000) with *B. campestris* (cultivars Tori 7, TS-72, SS-75, BARI Sarisha 6, BARI Sarisha 9 and BARI Sarisha 12), *B. juncea* (cultivars Rai-5, Daulat, BARI Sarisha 10 and BARI

Sarisha 11) and *B. napus* (cultivars BARI Sarisha-7, BARI Sarisha 8 and Nap-248) and three sowing dates, viz. 20 October, 11 November and 5 December to study the performance of rapeseed-mustard cultivars for early and late sowing situation. They observed that sowing date and variety has significantly influenced plant height, siliqua plant⁻¹, seeds siliqua⁻¹, seed yield, stover dry weight, Days to 50% flowering, maturity and oil content of seed in both the years. Days to 50% flowering and maturity were different among the different planting time in the growing season of the experimental area.

Table 8. Combined effect of sowing time and variety on days to 50% flowering of mustard in three growing seasons at research field.

Treatments		Days to 50% flowering		
Sowing time	Variety	2014-2015	2015-2016	2016-2017
S ₁	V ₁	29.67 f	30.00 de	30.33c
	V ₂	44.33 a	42.00 a	41.33a
	V ₃	35.00 d	33.00 cd	31.33bc
	V ₄	37.67 b	36.67 b	36.00b
S ₂	V ₁	29.67 f	32.00 c-e	31.67bc
	V ₂	44.67 a	42.33 a	42.00a
	V ₃	34.67 de	32.67 cd	32.00bc
	V ₄	37.33 b	34.67 bc	33.33bc
S ₃	V ₁	29.67 f	29.00 e	28.67c
	V ₂	44.00 a	42.67 a	42.67a
	V ₃	34.00 e	32.67 cd	32.67bc
	V ₄	36.33 c	37.00 b	35.33 b
LS		*	*	*
CV (%)		6.61	3.20	4.28
LSD (5%)		1.49	5.35	7.28

Means followed by the same letter (s) do not statistically differ at 5% level tested by DMRT. Here, * and ** indicate significant effect at 5% and 1% level of probability respectively. NS = Non-significant

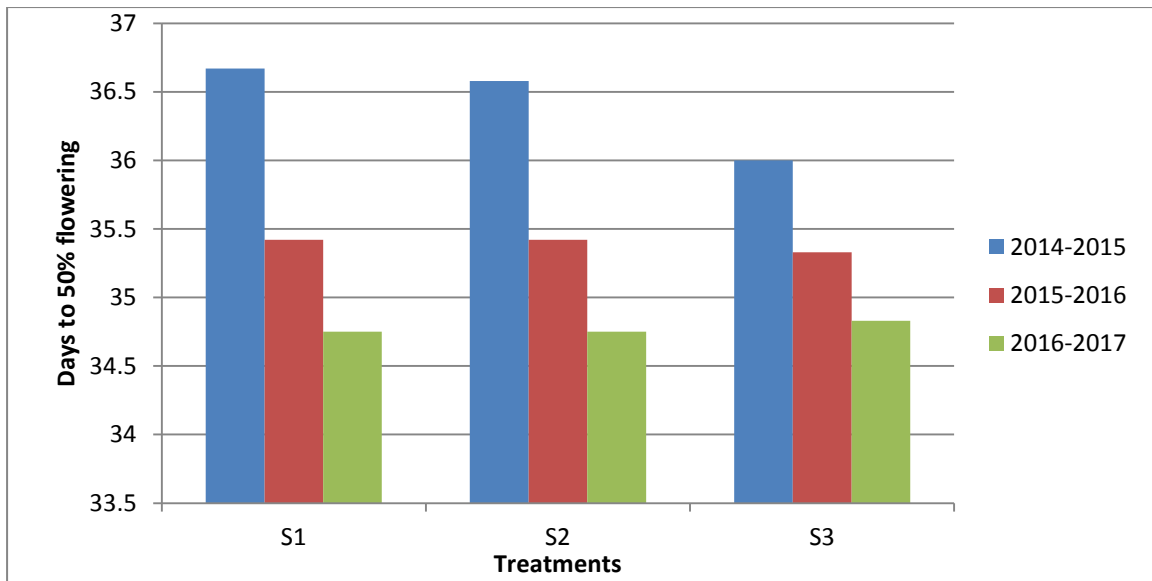

Figure 9. Effect of sowing time on days to 50% flowering of mustard in the growing seasons of 2014-2015, 2015-2016 and 2016-2017 in research field.

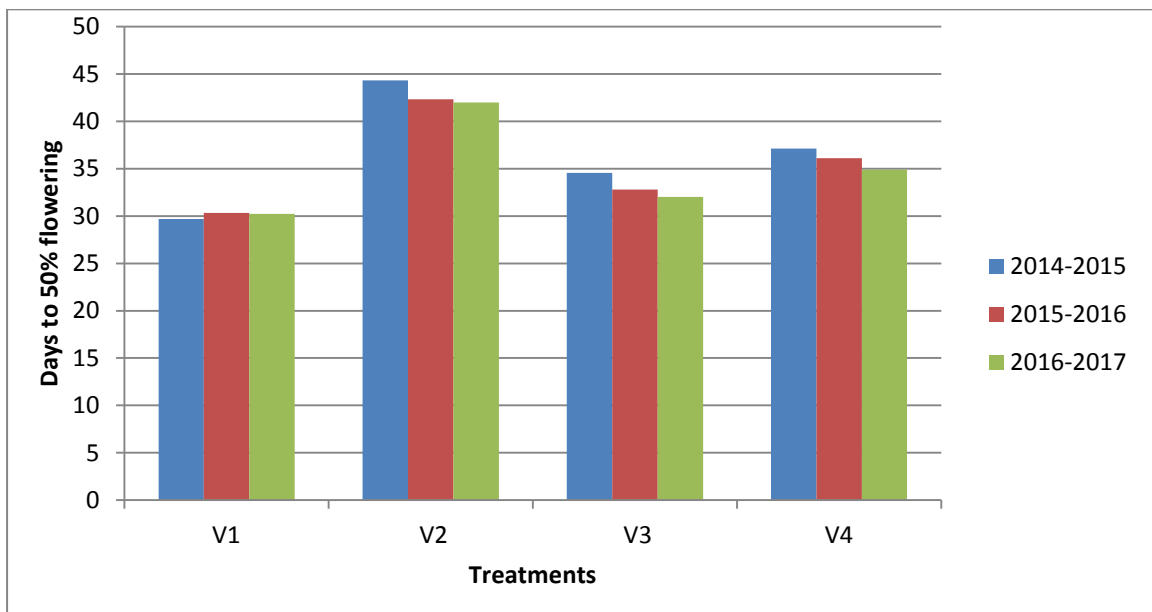

Figure 10. Effect of variety on days to 50% flowering of mustard in the growing seasons of 2014-2015, 2015-2016 and 2016-2017 in research field.

4.2.5 Days to maturity

Treatment combination of sowing time and variety display significant variation in case of days needed to maturity of mustard in the growing seasons of 2014-2015, 2015-2016 and 2016-2017 and that was presented in Table 9 and Figures 11-12.

Treatment S_1V_2 required the maximum days for maturity (106.00) in the growing seasons of 2014-2015 and 2015-2016, both in 2016-2017 treatment S_3V_2 required the maximum days (104.70) which were statistically similar with S_1V_2 , S_2V_2 and S_3V_2 . The minimum days required (77.33, 75.00 and 77.33) by treatment S_2V_1 which were statistically similar with treatment S_1V_1 and S_3V_1 in all the growing seasons (Table 9).

Different sowing time required different days for maturity of mustard. Treatment S_1 required the maximum days for maturity whereas treatment S_3 required the minimum days in all three growing seasons which were statistically non-significant (Figure 11).

Figure 12 indicates that among four different varieties treatment V_2 required the maximum days for maturity and treatment V_1 required the minimum which were significantly different from all other treatments in all three growing seasons.

These results are more or less similar with the results of Raquibullah *et al.* (2006) where they conducted a field experiment at the Central Research Station of BARI, Joydebpur, Gazipur, Bangladesh, for two consecutive years (1998-99 and 1999-2000) with *B. campestris* (cultivars Tori 7, TS-72, SS-75, BARI Sarisha 6, BARI Sarisha 9 and BARI Sarisha 12), *B. juncea* (cultivars Rai-5, Daulat, BARI Sarisha 10 and BARI Sarisha 11), and *B. napus* (cultivars BARI Sarisha 7, BARI Sarisha 8 and Nap-248) and three sowing dates, viz., 20 October, 11 November and 5

December to study the performance of rapeseed-mustard cultivars for early and late sowing situation. They observed that sowing date has significantly influenced to plant height, siliqua plant⁻¹, seeds siliqua⁻¹, seed yield, stover dry weight, 50% flowering, maturity and oil content of seed in both the years. Maturity was different among the different planting time in the varieties during the growing season of the experimental area.

Table 9. Combined effect of sowing time and variety on days to maturity of mustard in three growing seasons at research field.

Treatments		Days to maturity		
Sowing time	Variety	2014-2015	2015-2016	2016-2017
S ₁	V ₁	77.67 e	77.00 c	77.00 c
	V ₂	106.0 a	106.0 a	104.0 a
	V ₃	81.00 c	81.33 b	82.00 b
	V ₄	85.33 b	84.67 b	84.00 b
S ₂	V ₁	77.33 e	75.00 c	73.33 c
	V ₂	105.7 a	105.3 a	102.0 a
	V ₃	80.33 cd	81.33 b	82.00 b
	V ₄	84.67 b	85.00 b	84.00 b
S ₃	V ₁	78.00 e	76.00 c	74.00 c
	V ₂	105.3 a	104.0 a	104.7 a
	V ₃	79.67 d	82.00 b	81.00 b
	V ₄	84.67 b	82.67 b	82.00 b
LS		*	*	*
CV (%)		0.70	3.762	3.835
LSD (5%)		1.03	2.56	2.64

Means followed by the same letter (s) do not statistically differ at 5% level tested by DMRT. Here, *and ** indicate significant effect at 5% and 1% level of probability respectively. NS = Non-significant

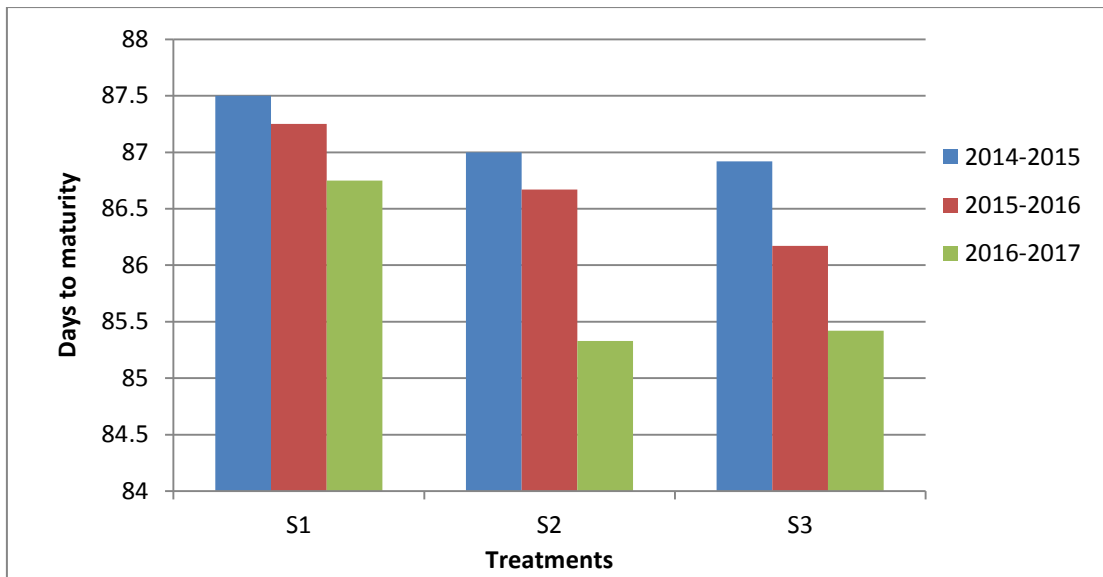

Figure 11. Effect of sowing time on days to maturity of mustard at different days after sowing in the growing seasons of 2014-2015, 2015-2016 and 2016-2017 in research field.

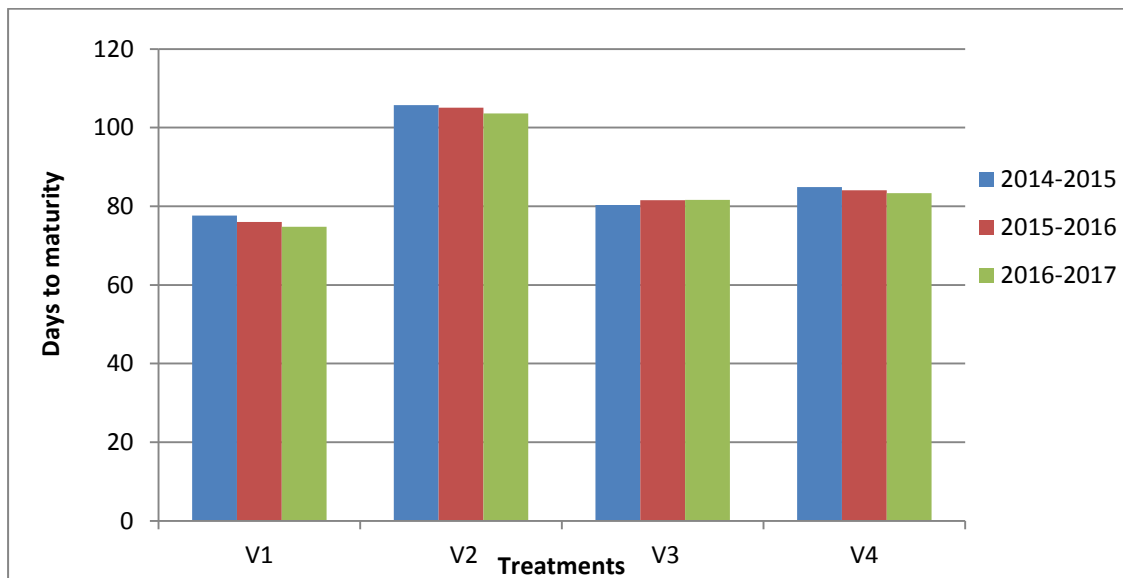

Figure 12. Effect of variety on days to maturity of mustard in the growing seasons of 2014-2015, 2015-2016 and 2016-2017 in research field.

4.2.6 Pod length (cm)

The interaction effect of sowing time and variety in relation to pod length was found significant. The results have been presented in Table 10 and Figures 13-14. In the growing season of 2014-2015 pod length was non-significant. The highest length of pod was recorded (5.86 and 5.70 cm) in 10 November sowing time with the variety BARI Sharisha 15 in growing season 2015-2016 and S_2V_1 in 3rd growing season whereas the lowest was recorded (4.00 cm) in S_2V_3 and S_3V_3 in the growing seasons of 2015-2016 and 2016-2017 which was significantly variation from all other treatments.

Length of pods were significantly influenced by sowing time among different growing seasons during the study period. The results have been presented in Figure 13. The longest pod was recorded in treatment S_2 in all three growing seasons and the lowest was in S_1 (2014-2015) and S_3 (2016-2017) which were significantly different from all other treatments. In 2015-2016 pod length was statistically non-significant.

Figure 14 indicates the pod length of mustard was significantly influenced the variety. In the growing season of 2014-2015 it was statistically non-significant. In the growing season of 2015-2016 and 2016-2017, treatment V_1 produced the highest pod length and V_3 produced the lowest which were statistically different from all other treatments.

This finding supports the findings of BARI (1999) which he found that varieties showed significant variation of pod length. Highest pod length was observed from Daulat and lowest in Dhali. This results also support the results of Hossain *et al.* (1996) which they observed the longest pod (8.07 cm) in BLN-900 and the shortest (4.83 cm) in Hyola-401. Results are in similar with the results of Jahan and Zakaria (1997) which they noticed that

the shortest pod length (4.62 cm) was found in the hybrid Semu-249/84 which was similar to those of Semu-DNK-89/218, AGH-7 and Tori 7. The longest pod (8.07 cm) was found in BLN-900 and Hyola-401.

Table 10. Combined effect of sowing time and variety on pod length (cm) of mustard in three growing seasons at research field.

Treatments		Pod length(cm)		
Sowing time	Variety	2014-2015	2015-2016	2016-2017
S ₁	V ₁	5.00 a	5.00 ab	5.25ab
	V ₂	4.00 a	4.75 ab	4.50 b-e
	V ₃	3.95 a	4.50 b	4.55 b-e
	V ₄	4.10 a	4.80 ab	4.85 b-e
S ₂	V ₁	4.99 a	5.20 ab	5.70 a
	V ₂	4.70 a	4.60 ab	4.80 b-e
	V ₃	4.95 a	4.00 b	4.75 b-e
	V ₄	5.00 a	5.86 a	5.10 a-c
S ₃	V ₁	5.10 a	4.81 ab	5.00 a-d
	V ₂	4.48 a	4.75 ab	4.15 de
	V ₃	4.50 a	4.25 b	4.00 e
	V ₄	4.75 a	4.51 b	4.25 c-e
LS		*	*	*
CV (%)		1.11	1.13	0.75
LSD (5%)		8.30	18.02	21.65

Means followed by the same letter (s) do not statistically differ at 5% level tested by DMRT. Here, *and ** indicate significant effect at 5% and 1% level of probability respectively. NS = Non-significant.

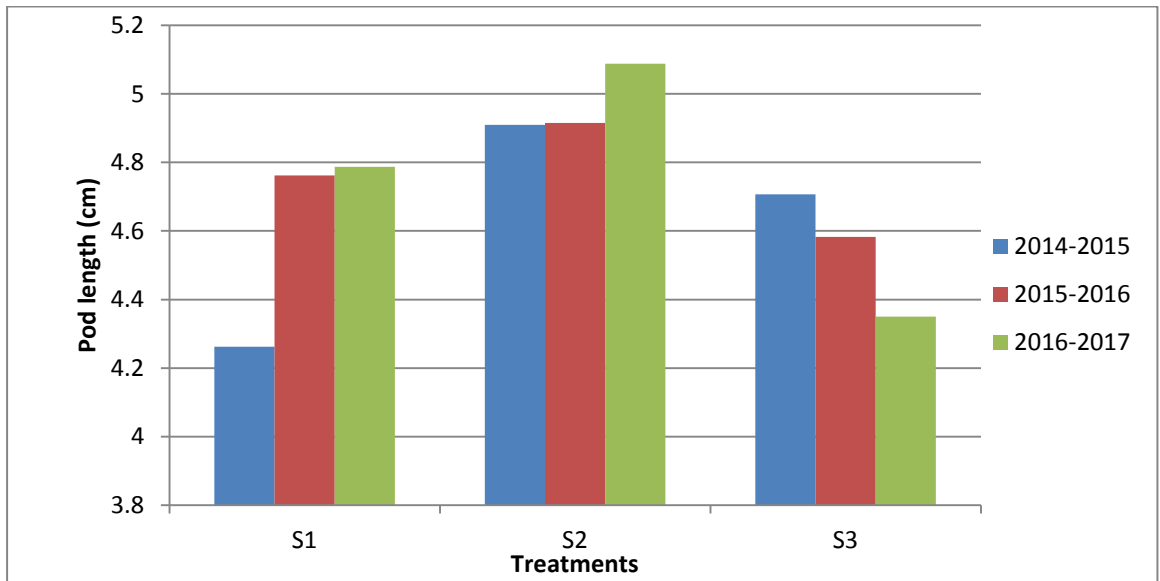

Figure 13. Effect of sowing time on pod length (cm) of mustard in the growing seasons of 2014-2015, 2015-2016 and 2016-2017 in research field.

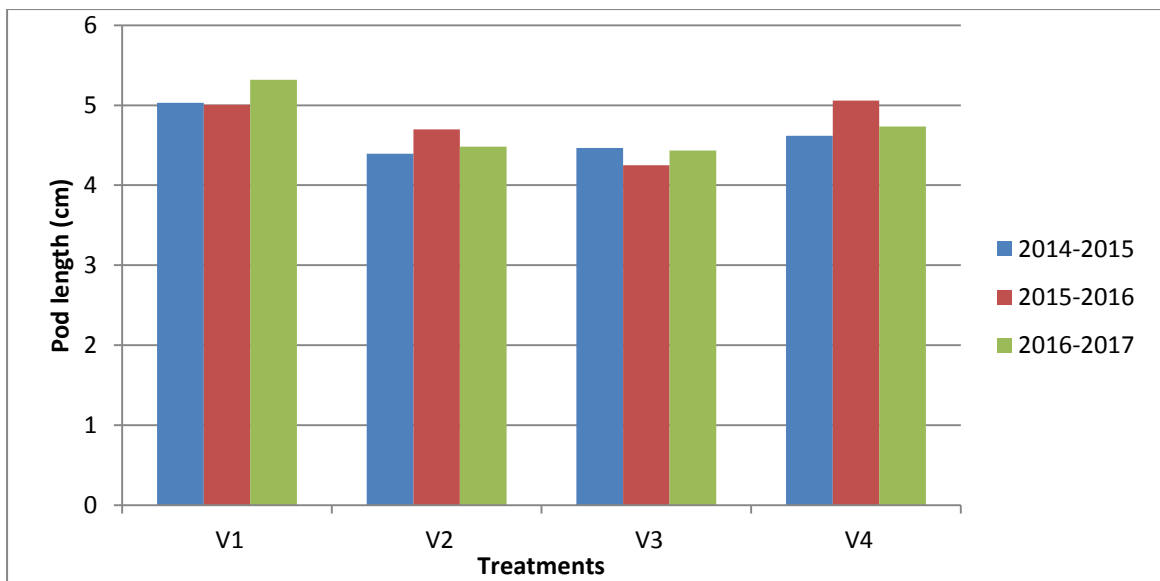

Figure 14. Effect of variety on pod length (cm) of mustard in the growing seasons of 2014-2015, 2015-2016 and 2016-2017 in research field.

4.2.7 Number of pods plant⁻¹

The interaction effect of sowing time and variety identified significant variation in relation to number of pods plant⁻¹ of mustard in three different growing seasons. The values are illustrated in Table-11 and Figures 15-16. The maximum number of pods plant⁻¹ 101.70 in 2014-2015, 118.30 in 2015-2016 and 141.30 in 2016-2017 were observed in treatments S₂V₂ and the lowest number of pods plant⁻¹ 68.25 in 2014-2015, 70.22 in 2015-2016 and 70.17 in 2016-2017 were found in the treatments S₃V₁ which were different from all other treatments (Table 11).

In case of sowing time number of pods plant⁻¹ were statistically non-significant in the growing seasons of 2014-2015 and 2015-2016. In the growing season of 2016-2017 the highest number of pods plant⁻¹ was produced by treatment S₂ and the lowest was in S₃ which were statistically different from all other treatments (Figure 15).

Figure 16 shows that among different varieties treatment V₂ produced the highest number of pods plant⁻¹ and treatment V₁ gave the lowest in all three growing seasons which were statistically different from all other treatments.

Results are more or less similar with the results of Mamun *et al.* (2014) which they conducted an experiment and observed that highest siliqua plant⁻¹ (126.90) was obtained in BARI Sarisha 13 which was more than three times higher than the lowest number of siliqua plant⁻¹ (50.10) produced by SAU Sarisha 3. This finding also similar with Choudhary and Thakuria (1994) which they observed that number of siliqua plant⁻¹ recorded significantly higher under 15th November sowing (224) compared to 5th December sowing (50 to 81). Reddy and Avail Kumar

(1997) observed that the number of siliqua per plant recorded higher under 4th October sowing (142) compared to 5 November sowing (93).

This result is similar with the result of Raquibullah *et al.* (2006) which they reported that date of sowing significantly influenced the number of pods plant⁻¹. This result is also support the result of Kumar *et al.* (2004) which they described that maximum pods plant⁻¹ were recorded when the crop was planted on 21 October. These results are in agreement with the result of Sharma *et al.* (2006) which they found that pods plant⁻¹ were maximum in the crop sown on 22 and 29 October compared to early and late sowing of 6 October and 12 November respectively. This finding support the findings of Buttar and Aulakh (1999) which they observed that pods plant⁻¹ were higher in 25 October (1st date) sowing. This was due to cause that under earlier sown crop, the temperature and all other climatological parameters played a major role for growth and yield attributes. These results are more or less similar with the result of Brar *et al.* (1998) which they stated that early sown crop produced higher number of pods plant⁻¹ compared to late sowing. Sowing at 30 October and 15 November were at par with each other but further delay in sowing caused significant reduction in number of pods plant⁻¹.

4.2.8 Number of seeds pod⁻¹

Number of seeds pod⁻¹ varied significantly cause of combined effect of sowing time and variety. Data on number of seeds pod⁻¹ were recorded and are presented in Table 12 and Figures 17-18. Maximum number of seeds pod⁻¹ (26.00, 27.00 and 26.67) were observed in treatments S₁V₃, and the minimum (12.00, 10.67 and 11.00) were found in treatments S₂V₂ in all three growing seasons which were significantly different from all other treatments (Table 12).

Table 11. Combined effect of sowing time and variety on number of pods plant⁻¹ of mustard in three growing seasons at research field.

Treatments		Number of pods plant ⁻¹		
Sowing time	Variety	2014-2015	2015-2016	2016-2017
S ₁	V ₁	90.00 abc	89.00 abc	89.25 de
	V ₂	100.0 ab	104.7 ab	120.2 b
	V ₃	70.00 c	70.22 c	72.22 gh
	V ₄	78.00 abc	78.73 bc	76.53 f
S ₂	V ₁	90.20 abc	95.25 abc	91.10 d
	V ₂	101.7 a	118.3 a	141.3 a
	V ₃	76.00 abc	72.00 bc	75.57 fg
	V ₄	72.20 bc	79.19 bc	78.65 f
S ₃	V ₁	68.25c	70.22 c	70.17 h
	V ₂	95.25 abc	100.1 abc	98.18 c
	V ₃	85.00 abc	75.00 bc	86.33 e
	V ₄	73.00 bc	89.00 abc	71.25 h
LS		*	*	*
CV (%)		24.71	28.45	4.017
LSD (5%)		5.65	8.16	7.54

Means followed by the same letter (s) do not statistically differ at 5% level tested by DMRT. Here, *and ** indicate significant effect at 5% and 1% level of probability respectively. NS = Non-significant.

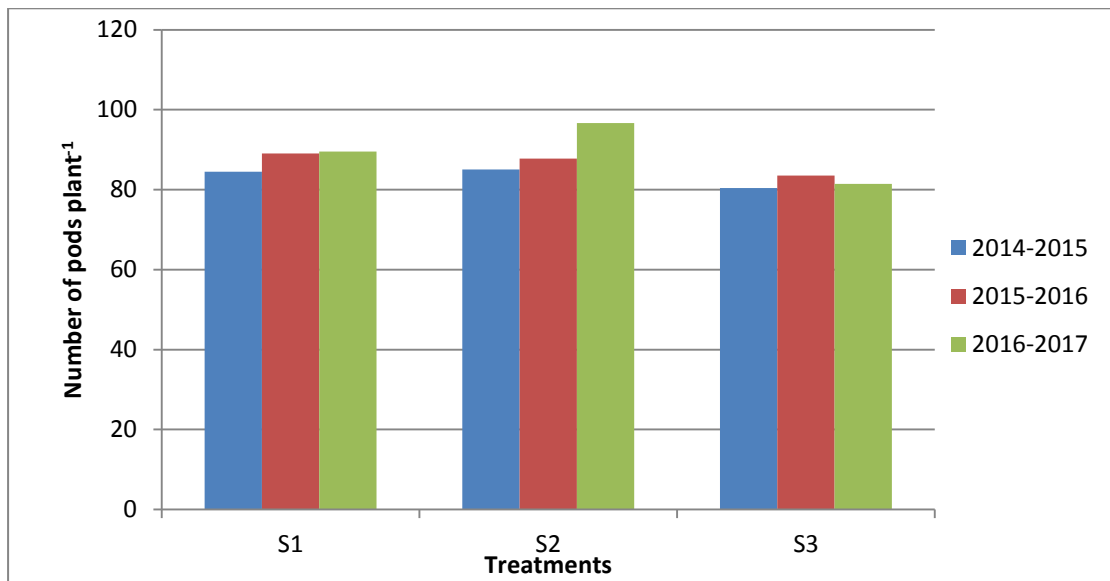

Figure 15. Effect of sowing time on number of pods plant⁻¹ of mustard in the growing seasons of 2014-2015, 2015-2016 and 2016-2017 in research field.

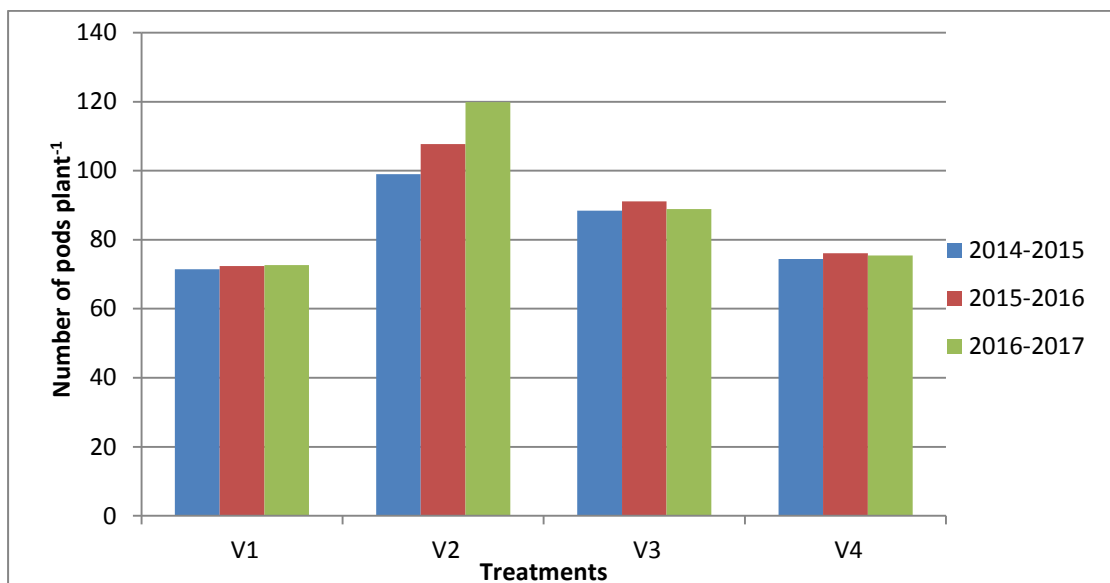

Figure 16. Effect of variety on number of pods plant⁻¹ of mustard in the growing seasons of 2014-2015, 2015-2016 and 2016-2017 in research field.

Figure 17 indicated that sowing time influence the number of seeds pod^{-1} . In growing season of 2014-2015 it was non-significant. Treatment S_3 produced the maximum seeds pod^{-1} and S_2 give the minimum in the rowing seasons of 2015-2016 and 2016-2017 which were statistically similar with treatment S_1 .

Number of seeds pod^{-1} significantly varietal influenced. Treatment V_3 produced the highest number of seeds pod^{-1} and V_2 gave the lowest in all three growing seasons which were statistically different from all other treatments (Figure 18).

This results support the results of Jahan and Zakaria (1997) which they demonstrated among the entries Dhali produced the maximum number of seeds pod^{-1} (26.13) which was at par with Sonali (23.5) and Jatorai (22.8). The minimum number of seeds pod^{-1} (18.0) was found in Tori 7 which was at par with that in Sampad (20.0), Hyole 401 (20.3), BARI Sarisha 7 (20.5), AGA-95-21 (20.7) and BARI Sarisha 8 (21.6).

This result also support the result of Das *et al.* (1999) which they noted that MM - 7 (Mutant) produced the maximum number of seeds pod^{-1} (29.2) followed by MM - 20 (Mutant) (28.0) and BINA Sarisha-4 (27.8) at Dinajpur.

This finding more or less similar with the findings of Mondal *et al.* (1992) found that the highest number of seeds pod^{-1} (27.6) in SS-75 which was significantly variation from all other varieties. The lowest number of seeds pod^{-1} (13.8) was found in J-5004.

Table 12. Combined effect of sowing time and variety on number of seeds pod⁻¹ of mustard in three growing seasons at research field.

Treatments		Number of seeds pod ⁻¹		
Sowing time	Variety	2014-2015	2015-2016	2016-2017
S ₁	V ₁	16.33 c	16.00 d	15.67 e
	V ₂	12.67 d	12.33 e	13.00 f
	V ₃	26.00 a	27.00 a	26.67 a
	V ₄	23.33 b	22.67 c	21.00 d
S ₂	V ₁	15.67 c	16.00 d	16.00 e
	V ₂	12.00 d	10.67 e	11.00 g
	V ₃	25.67 a	26.00 a	25.33 b
	V ₄	24.67 b	25.00 b	24.00 c
S ₃	V ₁	16.33 c	17.33 d	16.33 e
	V ₂	12.33 d	12.00 e	13.00 f
	V ₃	26.00 a	26.00 a	26.00 a
	V ₄	23.33 b	24.67 c	24.67 c
LS		*	**	**
CV (%)		2.83	2.59	1.91
LSD (5%)		7.60	5.33	4.02

Means followed by the same letter (s) do not statistically differ at 5% level tested by DMRT. Here, *and ** indicate significant effect at 5% and 1% level of probability respectively. NS = Non-significant.

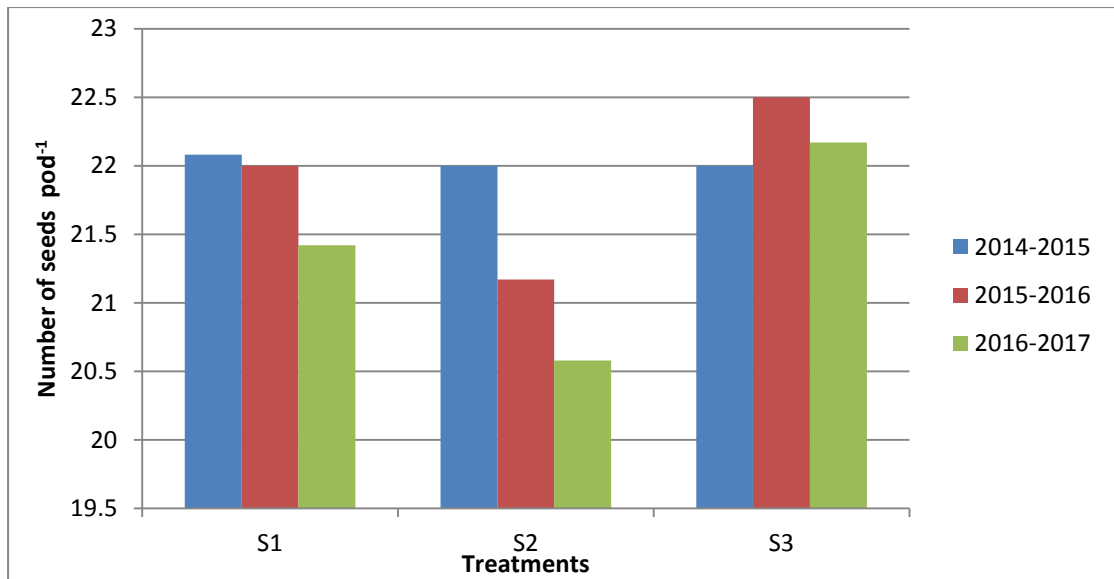

Figure 17. Effect of sowing time on number of seeds pod⁻¹ of mustard in the growing seasons of 2014-2015, 2015-2016 and 2016-2017 in research field.

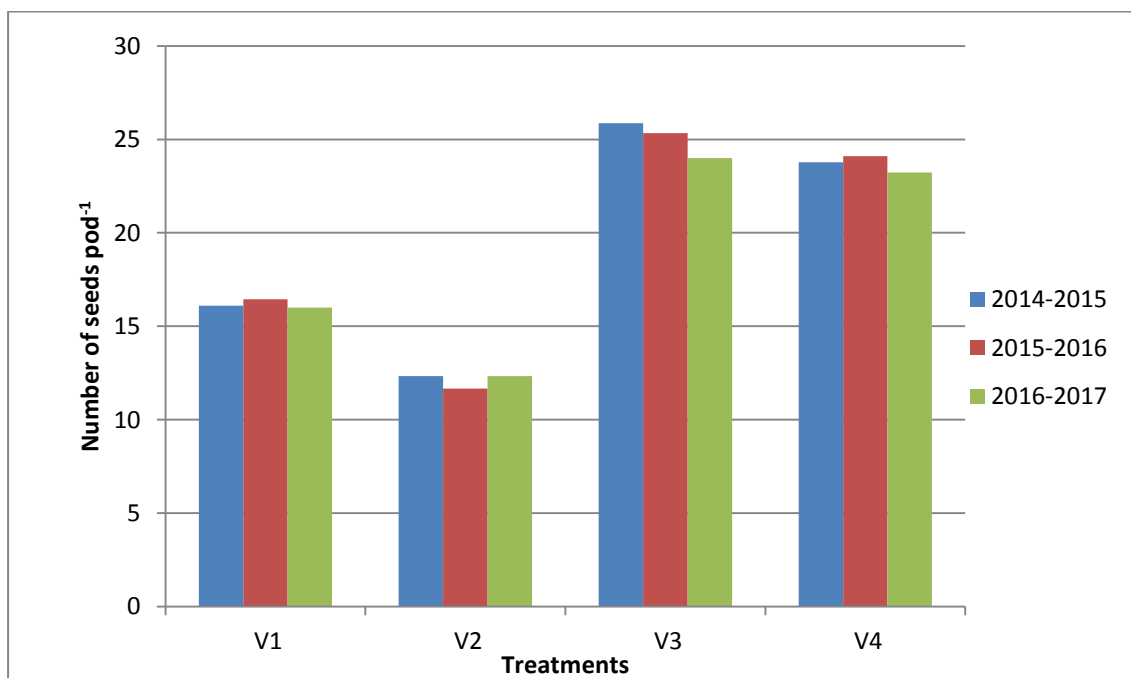

Figure 18. Effect of variety on number of seeds pod⁻¹ of mustard in the growing seasons of 2014-2015, 2015-2016 and 2016-2017 in research field.

4.2.9 Number of seeds plant⁻¹

The combined effect of sowing time and variety showed significant formed in relation to number of seeds plant⁻¹ of mustard in three different growing seasons. Recorded data are presented in Table 13 and Figures 19-20. In the growing seasons of 2014-2015, 2015-2016 and 2016-2017 highest number of seeds plant⁻¹ (1925.00, 2005.00 and 2010.00) were observed in treatment S₁V₃ which were significantly variation from all other treatments whereas the lowest number of seeds plant⁻¹(1300.00 and 1395.00) were found in S₁V₁ in 2104-2015 and 2015-2016 and 1277.00 in S₃V₂ which were also significantly different from all other treatments (Table 13).

Figure 19 showed that in the growing seasons of 2014-2015 and 2015-2016 treatment S₂ produced in highest number of seeds plant⁻¹ and S₃ gave the lowest number of seeds plant⁻¹. In the growing season of 2016-2017 it was statistically non-significant.

Different variety influence significant effect on number of seeds plant⁻¹ in different growing seasons. Treatment V₃ gave the highest number of seeds plant⁻¹ whereas treatment V₁ produced the lowest in all three growing seasons (Figure 20).

This results are more or less similar with the result of Takar and Jat (2005) which they observed the effect of sowing date on aphid incidence was least on early sown (10 October 2000) crops compared to late sown crops (30 October 2000). The highest yield was obtained in crops sown on 10 October and the crops sown after this date recorded drastic reductions in yield.

Results are in agreement with the result of Rahman (2002) who stated that yield variation existed among varieties and the maximum seed yield

was observed in BARI Sarisha 7, BARI Sarisha 8 and BARI Sarisha 11 (2.00-2.50 t ha⁻¹) and the minimum yield in variety Tori 7 (0.95-1.10 t ha⁻¹). BARI (2001) observed that seed yield and other yield contributing characters significantly varied among the varieties.

Table 13. Combined effect of sowing time and variety on number of seeds plant⁻¹ of mustard in three growing seasons at research field.

Treatments		Number of seeds plant ⁻¹		
Sowing time	Variety	2014-2015	2015-2016	2016-2017
S ₁	V ₁	1300.00 h	1395.00 h	1398.00 d
	V ₂	1501.00 f	1558.00 f	1563.00 cd
	V ₃	1925.00 a	2005.00 a	2010.00 a
	V ₄	1510.00 f	1575.00 f	1579.00cd
S ₂	V ₁	1400.00 g	1455.00 g	1458.00 cd
	V ₂	1520.00 f	1548.00 f	1554.00cd
	V ₃	1865.00 b	1840.00 c	2001.00 a
	V ₄	1750.00 d	1810.00 d	1888.00 b
S ₃	V ₁	1400.00 g	1400.00 h	1410.00 d
	V ₂	1200.00 i	1250.00 i	1277.00 d
	V ₃	1800.00 c	1910.00 b	1995.00a
	V ₄	1700.00e	1740.00 e	1757.00 bc
LS		*	*	*
CV (%)		42.86	44.19	278.3
LSD (5%)		12.25	12.11	11.32

Means followed by the same letter (s) do not statistically differ at 5% level tested by DMRT. Here, *and ** indicate significant effect at 5% and 1% level of probability respectively. NS = Non-significant.

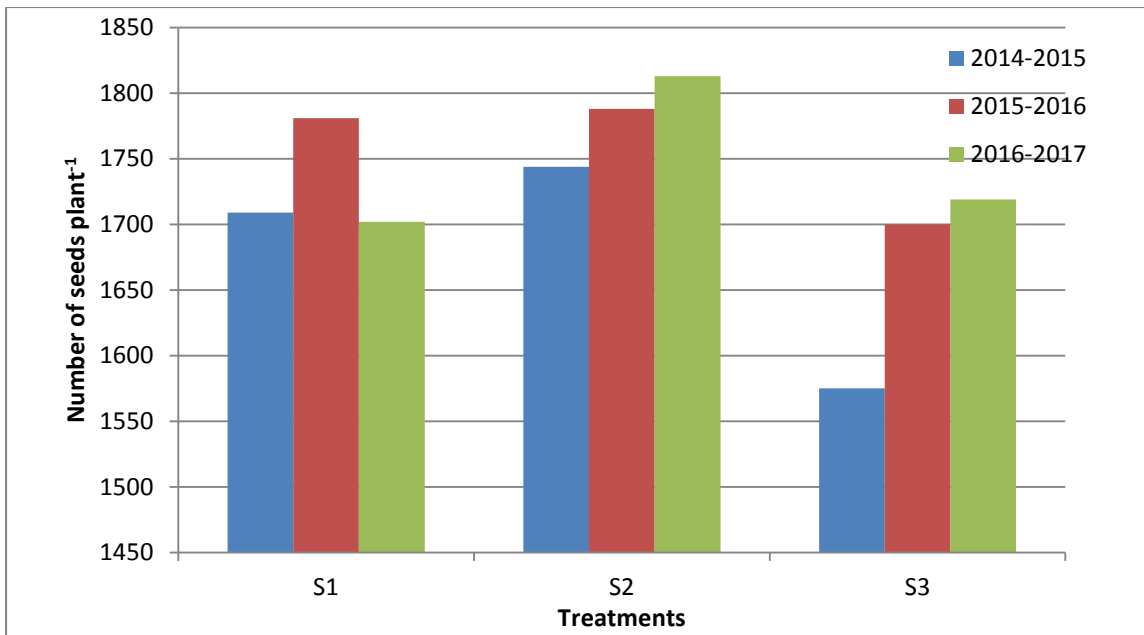

Figure 19. Effect of sowing time on number of seeds plant⁻¹ of mustard in the growing seasons of 2014-2015, 2015-2016 and 2016-2017 in research field.

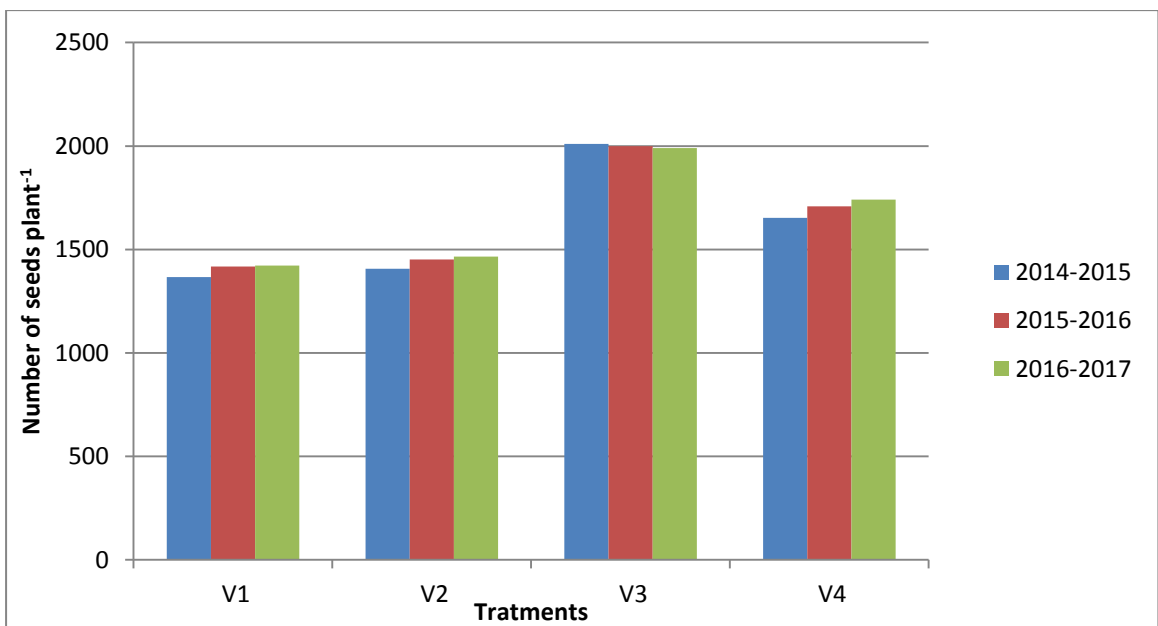

Figure 20. Effect of variety on number of seeds plant⁻¹ of mustard in the growing seasons of 2014-2015, 2015-2016 and 2016-2017 in research field.

4.2.10 1000-seeds weight (g)

1000-seeds weight varied significantly due to combined effect of sowing time and variety. The effect of sowing time and variety are present in Table 14 and Figures 21-22.

In all three growing seasons treatment S_2V_2 produced the highest 1000-seeds weight (3.33g, 3.43g and 3.30g) which was statistically variation from all other treatments. On the other hand treatment S_3V_1 gave minimum 1000-seeds weight (2.70g, 2.70g and 2.70g) which was also statistically different from all other treatments (Table 14).

The effect of sowing time on 1000-seeds weight was statistically non-significant in all three growing seasons (Figure 21). Figure 22 indicated that all the three growing seasons treatment V_2 produced the maximum 1000-seeds weight whereas V_1 gave the minimum which were statistically different from all other treatments.

These results are more or less similar with the results of Hossain *et al.* (1984) and Uddin *et al.* (1986) which they concluded that the middle of October was the most suitable time of sowing of rapeseed and mustard in Bangladesh.

Results are in similar with the results of Mondal and Wahab (2001) which they showed that 1000-seeds weight was 2.5-2.65g in improved Tori 7 (*B. campestris*) and 1.5-7.8g in Rai 5 (*B. juncea*).

These results are also similar with the results of BARI (2001) which they concluded that there was significant variation in 1000-seeds weight of mustard observed in different varieties and maximum weight of 1000-seeds was found in jamalpur-1 variety and minimum in BARI Sarisha 10.

This findings are similar with the findings of Hussain *et al.* (1998) which they found significant different in case of 1000-seeds weight as formed by different varieties. They found Hyda-401 had the maximum 1000-seeds weight (3.4g) and the minimum 1000-seeds weight was recorded in Tori 7 (2.1g).

Table 14. Combined effect of sowing time and variety on 1000- seeds weight (g) of mustard in three growing seasons at research field.

Treatments		1000-seeds -weight (g)		
Sowing time	Variety	2014-2015	2015-2016	2016-2017
S ₁	V ₁	2.89ab	2.71c	2.72 b
	V ₂	3.07 ab	3.07a-c	3.03ab
	V ₃	3.30 a	3.30ab	3.30 a
	V ₄	2.90ab	2.90bc	2.90ab
S ₂	V ₁	2.72 b	2.72c	2.90ab
	V ₂	3.33 a	3.43a	3.30 a
	V ₃	3.30 a	3.30ab	3.07 ab
	V ₄	2.90 ab	2.90bc	2.93 ab
S ₃	V ₁	2.72 b	2.70 c	2.70 b
	V ₂	2.95 ab	3.00a-c	2.93ab
	V ₃	3.07 ab	3.07 a-c	3.27 a
	V ₄	3.23 a	2.90bc	2.90ab
LS		*	*	*
CV (%)		0.41	0.44	0.35
LSD (5%)		8.00	8.69	6.94

Means followed by the same letter (s) do not statistically differ at 5% level tested by DMRT. Here, *and ** indicate significant effect at 5% and 1% level of probability respectively. NS = Non-significant.

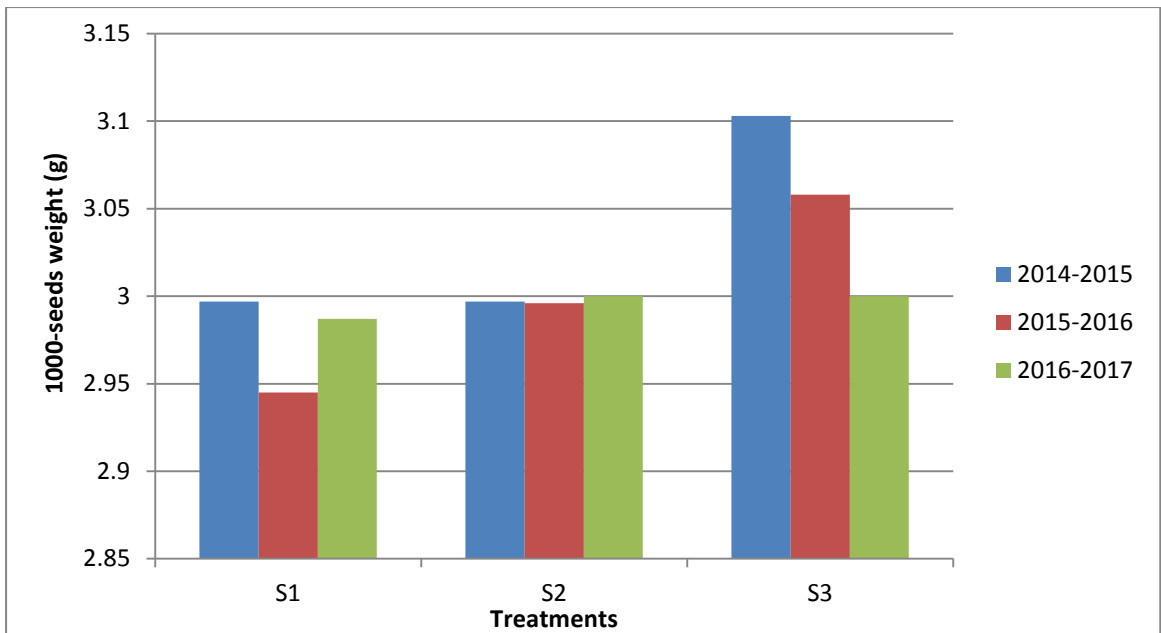

Figure 21. Effect of sowing time on 1000-seeds weight (g) of mustard in the growing seasons of 2014-2015, 2015-2016 and 2016-2017 in research field.

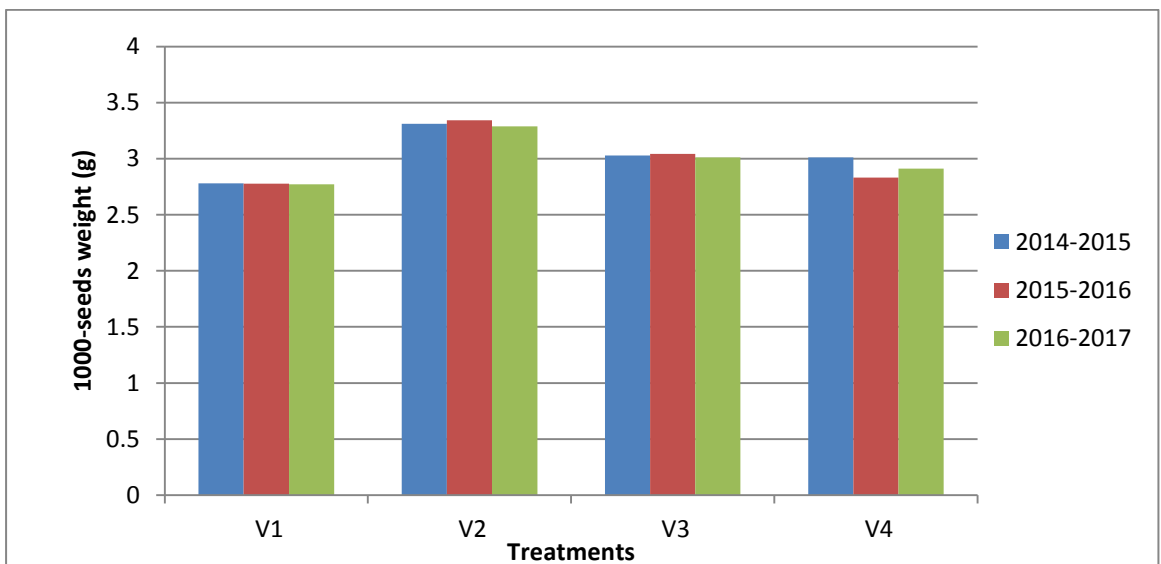

Figure 22. Effect of variety on 1000- seeds weight (g) of mustard in the growing seasons of 2014-2015, 2015-2016 and 2016-2017 in research field.

4.2.11 Seed yield (kg ha⁻¹)

The combined effect of sowing time and variety on seed yield of mustard varied significantly and are shown in Table 15 and Figures 23-24. In the growing seasons of 2014-2015, 2015-2016 and 2016-2017, the maximum seed yield (2195.00, 2280.00 and 2286.00 kg ha⁻¹) were found from treatment S₂V₂ which were significantly different from all other treatments (Table 15). On the other hand, the lowest were (1270.00, 1210.00 and 1280.00 kg ha⁻¹) were observed in treatment S₃V₁ which was followed by S₁V₁, S₂V₁ and S₃V₃ in 2014-2015 but they are significantly different from all other treatments in the growing seasons of 2015-2016 and 2016-2017.

In case of effect of sowing time, treatment S₂ produced the highest seed yield whereas treatment S₃ gave the lowest in all three growing seasons which were significantly different from all other treatments (Figure 23).

Figure 24 indicated that different variety influence seed yield significantly. The maximum seed yield found in treatment V₂ and the minimum were observed in treatment V₁ in all three growing seasons which were statistically different from all other treatments.

These results are in agreement with the results of Kumar and Sharma (2006) which they found that delay in sowing beyond 5 November significantly decreased the yields of Indian mustard.

This result is similar with the result of (Kondra, 1977; Degenhardt and Kondra, 1981) which they observed decreased seed yield of *B. napus* and *B. campestris* with delayed sowing.

This result is also similar with the result of Rahman (2002) where he observed that the highest seed yield in BARI Sarisha 7, BARI Sarisha 8 and BARI Sarisha 11 (2.00-2.50 kg ha⁻¹) and the lowest yield in variety Tori 7 (0.95-1.10 kg ha⁻¹).

Table 15. Combined effect of sowing time and variety on seed yield (kg ha⁻¹) of mustard in three growing seasons at research field.

Treatments		Seed yield (kg ha ⁻¹)		
Sowing time	Variety	2014-2015	2015-2016	2016-2017
S ₁	V ₁	1280.00 d	1301.00 f	1320.00 k
	V ₂	1810.00bc	2100.00 b	2157.00 b
	V ₃	1450.00 cd	1425.00 e	1490.00 h
	V ₄	1570.00b-d	1530.00 d	1580.00 e
S ₂	V ₁	1300.00 d	1310.00 f	1376.00j
	V ₂	2195.00 a	2280.00a	2286.00a
	V ₃	1818.00bc	1490.00 d	1515.00g
	V ₄	1598.00b-d	1585.00 c	1601.00d
S ₃	V ₁	1270.00 d	1210.00 g	1280.00l
	V ₂	1900.00ab	2110.00 b	2100.00c
	V ₃	1425.00 d	1430.00 e	1475.00 i
	V ₄	1500.00 cd	1536.00 d	1549.00 f
LS		*	*	*
CV (%)		2.56	2.27	1.71
LSD (5%)		330.30	46.71	9.21

Means followed by the same letter (s) do not statistically differ at 5% level tested by DMRT. Here, *and ** indicate significant effect at 5% and 1% level of probability respectively. NS = Non-significant.

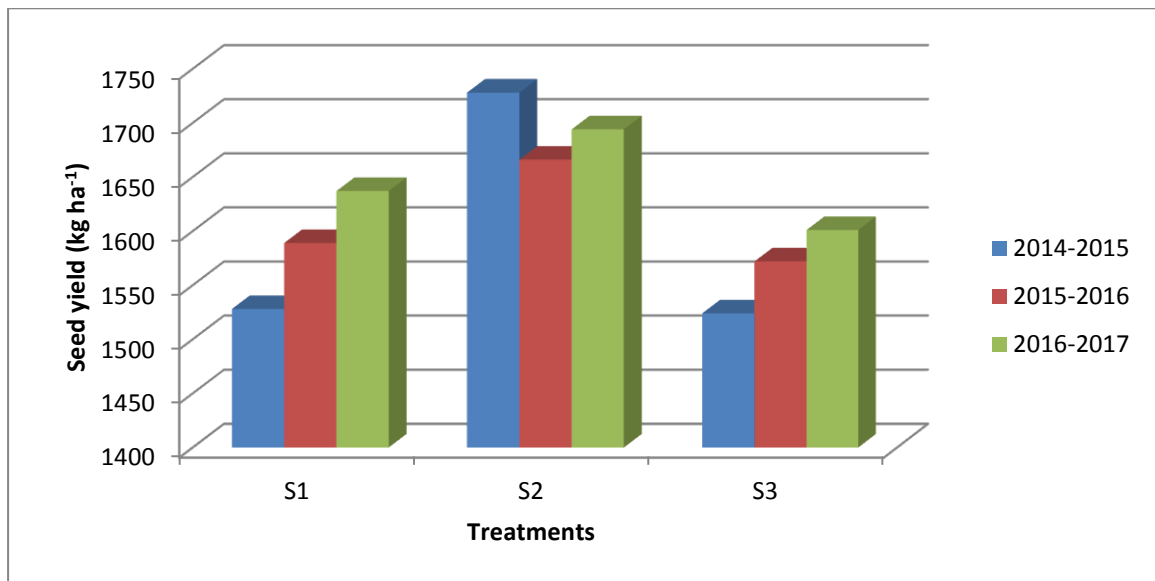

Figure 23. Effect of sowing time on seed yield (kg ha⁻¹) of mustard in the growing seasons of 2014-2015, 2015-2016 and 2016-2017 in research field.

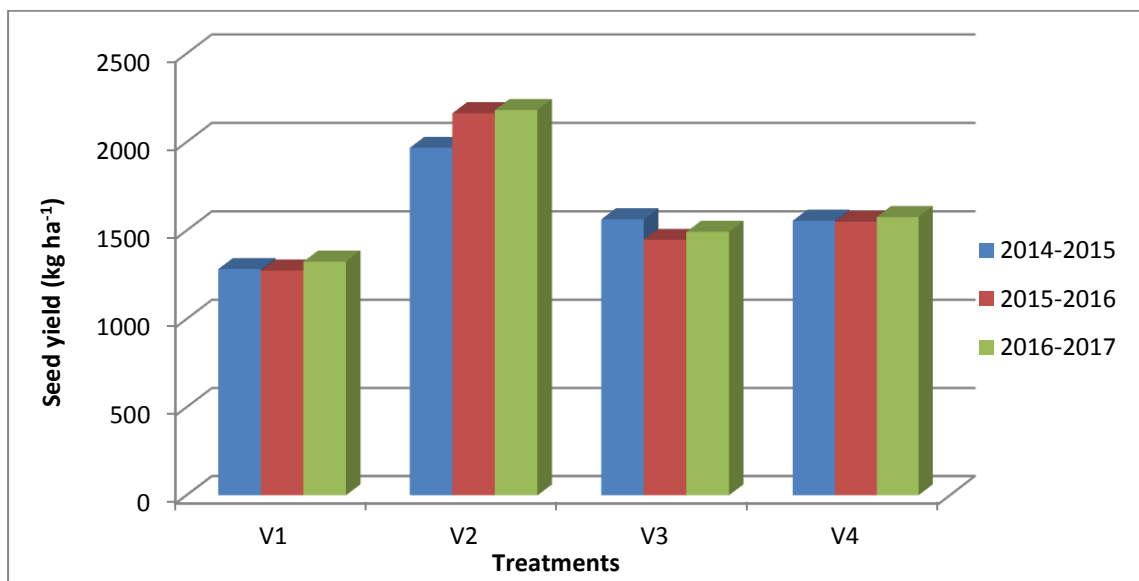

Figure 24. Effect of variety on seed yield (kg ha⁻¹) of mustard in the growing seasons of 2014-2015, 2015-2016 and 2016-2017 in research field.

4.2.12 Straw yield (kg ha⁻¹)

Straw yield of mustard variety significantly with the influence of sowing time, variety and their combination in all three growing seasons. The highest straw yield (2700.00, 2700.00 and 2751.00 kg ha⁻¹) were observed from the treatment S₂V₂ which was statistically different from all other treatments in 2014-2015 but, in 2015-2016 and 2016-2017 it was statistically agreement with S₁V₂ and S₃V₂. The minimum straw yield (2230.00, 2200.00 and 2250.00 kg ha⁻¹) were observed in treatment S₃V₄ which was statistically agreement with S₁V₄ in 2014-2015, 2015-2016; S₁V₄ and S₂V₄ in 2016-2017 (Table 16).

The effect of sowing time on straw yield (kg ha⁻¹) was statistically significant. The results have been presented in Figure 25. The highest straw yield was produced in treatment S₂ and the lowest was produced in S₁ in the growing season of 2014-2015 at research field. In case of growing season of 2015-2016 and 2016-2017 the maximum straw yield was observed in treatment S₂ and the minimum was in treatment S₃ which were statistically different from all other treatments.

The effect of variety on straw yield (kg ha⁻¹) was found in very much significant. The results have been presented in Figure 26. Among four different varieties, V₂ (BARI Sharisha 11) produced maximum straw yield in all the three growing seasons whereas the minimum straw yield were found in treatment V₄ in the growing seasons of 2014-2015, 2015-2016 and 2016-2017 which were statistically different from all other treatments.

These results are in agreement with the results of Yadav *et al.* (1994) which they observed that crop sown on 5th October recorded significantly higher straw yield (4370 kg ha⁻¹) as compared to 25th October sowing (3550 kg ha⁻¹). In Jagtial (Andhra Pradesh), Reddy and Availkumar (1997) conducted a field experiment and reported that straw yield recorded higher

under 4th October sowing (2111 kg ha⁻¹) as compared to 5th November sowing (1398 kg ha⁻¹).

Singh and Singh (2002) conducted a field trial at Faizabad (Uttar Pradesh) and recorded higher straw yield with 14th October sowing as compared to 29th October, 13th November and 28th November sowing.

In Jorhat (Assam), Kurmi and Kalita (1992) suggested that straw yield recorded was higher in 17th November sowing (2224 kg ha⁻¹) as compared to 2nd December sowing (1896 kg ha⁻¹).

In Udaipur, Rajendra Kumar and Shaktawat (1992) conducted a field trial and suggested that sowing of mustard on 22nd September recorded higher straw yield of 5264 kg per ha compared to 8th September sowing (4715 kg ha⁻¹).

4.2.13 Oil yield (kg ha⁻¹)

Sowing time, variety and their combined effect shows significant variation in relation to oil yield of mustard. The highest amount of oil (400.00 kg ha⁻¹) was obtained in treatment S₂V₂ which was significantly identical with all other treatments except S₁V₃, S₁V₄, S₂V₄, S₃V₃ and S₃V₄ whereas the lowest (300.00 kg ha⁻¹) was found in treatment S₃V₄ which was statistically identical with S₁V₃ and S₃V₃ in the growing season of 2014-2015 (Table 17). In 2015-2016, it was found highest (400.00 kg ha⁻¹) in S₁V₁ and lowest (316.70 kg ha⁻¹) in S₁V₂. In the growing season of 2016-2017, the highest oil yield (400.50 kg ha⁻¹) was observed in treatment S₂V₁ which was statistically identical with treatment S₁V₁ and S₂V₂ whereas the lowest oil yield (345.80 kg ha⁻¹) was found in treatment S₃V₄ which was significantly different from all other treatments (Table 17).

Table 16. Combined effect of sowing time and variety on straw yield (kg ha⁻¹) of mustard in three growing seasons at research field.

Treatments		Straw yield (kg ha ⁻¹)		
Sowing time	Variety	2014-2015	2015-2016	2016-2017
S ₁	V ₁	2300.00ef	2400.00d	2400.00e
	V ₂	2425.00cd	2700.00a	2715.00a
	V ₃	2500.00bc	2500.00c	2550.00bc
	V ₄	2270.00f	2220.00f	2290.00f
S ₂	V ₁	2450.00cd	2430.00d	2460.00de
	V ₂	2700.00a	2700.00a	2751.00a
	V ₃	2485.00c	2530.00c	2590.00b
	V ₄	2320.00ef	2310.00e	2300.00f
S ₃	V ₁	2375.00de	2300.00e	2391.00e
	V ₂	2595.00b	2610.00b	2680.00a
	V ₃	2500.00bc	2500.00c	2515.00cd
	V ₄	2230.00f	2200.00f	2250.00f
LS		*	*	*
CV (%)		2.35	1.31	1.68
LSD (5%)		96.68	54.47	70.77

Means followed by the same letter (s) do not statistically differ at 5% level tested by DMRT Here, *and ** indicate significant effect at 5% and 1% level of probability respectively. NS = Non-significant.

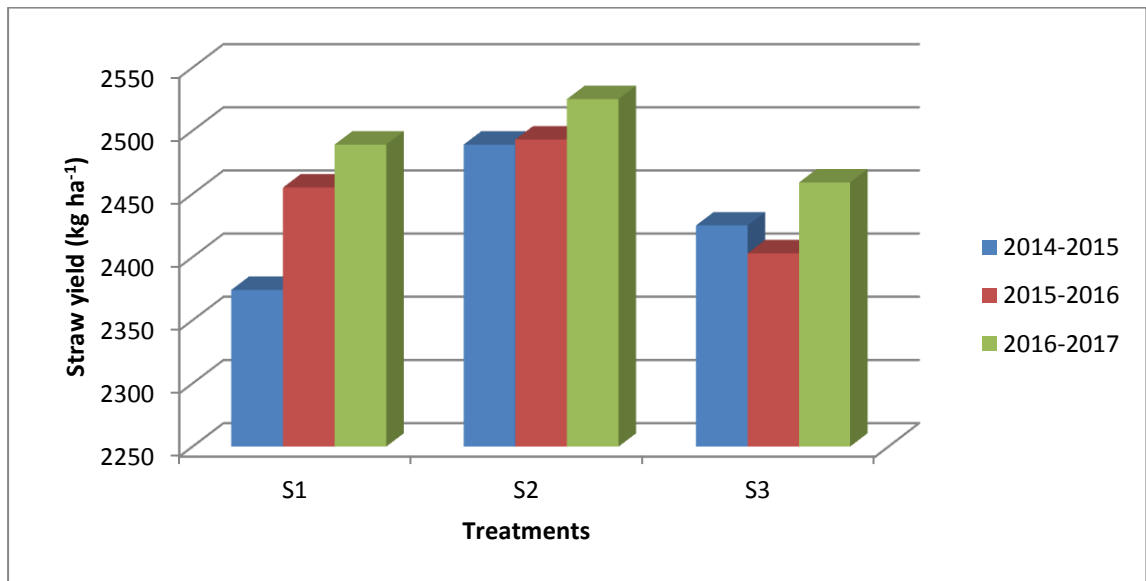

Figure 25. Effect of sowing time on straw yield (kg ha⁻¹) of mustard in the growing seasons of 2014-2015, 2015-2016 and 2016-2017 in research field.

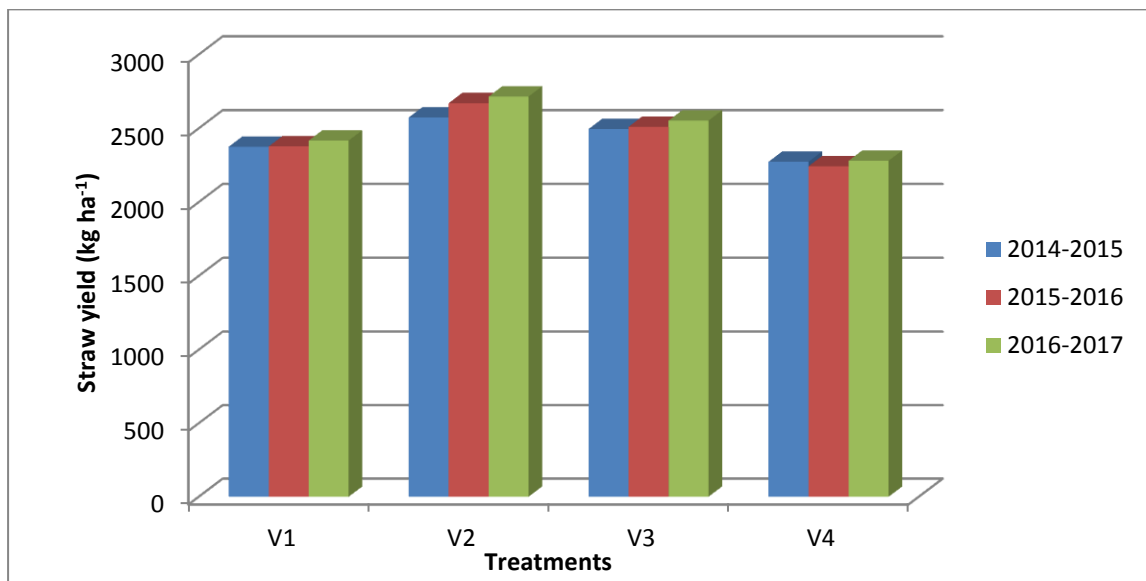

Figure 26. Effect of variety on straw yield (kg ha⁻¹) of mustard in the growing seasons of 2014-2015, 2015-2016 and 2016-2017 in research field.

Figure 27 indicates that among three different sowing times treatment S_2 produced the maximum oil yield in the growing seasons of 2014-2015, 2015-2016 and 2016-2017. On the other hand the lowest one was found in S_3 in the three different growing seasons in the experimental area which was significantly variation from all other treatments. In 2015-2016 it was found statistically non-significant.

The effect of variety on oil yield (kg ha^{-1}) was found in very much significant. The results have been presented in Figure 28. Among four different varieties, treatment V_2 produced maximum oil yield in the growing season 2014-2015 and the minimum was in treatment V_4 . In the growing season 2015-2016 treatment V_1 produced the maximum oil yield and the minimum was in treatment V_4 . Treatment V_1 produced the highest oil yield in the growing season of 2016-2017 and V_4 produced the minimum which were statistically different from all other treatments (Figure 28).

These results are in conformity with the findings of Mishra and Rana (1992) conducted a field experiment at Amar Singh College and observed that the oil yield recorded was higher under 30 cm row spacing (773 kg ha^{-1}) as compared to 45 cm row spacing (708 kg ha^{-1}).

In Baraut (Uttar Pradesh), Chauhan *et al.* (1993) conducted a field experiment quoted that the oil yield was higher under 30 cm row spacing (430 kg ha^{-1}) as compared to 40 cm row spacing (400 kg ha^{-1}).

Rana and Pachauri (2001) observed that oil yield recorded higher under 30 cm \times 10 cm spacing (620 kg ha^{-1}) as compared to 45 cm \times 15cm spacing (480 kg ha^{-1}). Bishnoi and Kanwar Singh (1979) conducted experiment at Haryana Agricultural University, Hissar and stated that oil yield recorded higher in 10th October sowing (880 kg ha^{-1}) as compared to 20th November sowing (380 kg ha^{-1}).

In Jorhat (Assam), Kurmi and Kalita (1992) reported that oil yield recorded higher with 17th November sowing (388.17 kg ha⁻¹) as compared to 2nd December sowing (818 kg ha⁻¹).

Das (1998) reported that sowing mustard on 27th October recorded higher oil yield as compared to 27th November. In Bikaner (Rajasthan), Sihag *et al.* (2003) conducted a field trial and reported that the higher oil yield (839.17 kg ha⁻¹) was obtained in 15th October sown crop.

Angrej Singh *et al.* (2002) suggested that oil yield was higher with 10th and 30th October sowing as compared to 20th November and 10th December sowing.

Table 17. Combined effect of sowing time and variety on oil yield (kg ha⁻¹) of mustard in three growing seasons at research field.

Treatments		Oil yield (kg ha ⁻¹)		
Sowing time	Variety	2014-2015	2015-2016	2016-2017
S ₁	V ₁	397.00 a	400.00 a	399.00 a
	V ₂	386.00 a	316.70 d	385.10 b
	V ₃	330.20cd	360.10 a-d	350.10 d
	V ₄	338.00 c	320.30d	348.20 d
S ₂	V ₁	398.00 a	370.10a-c	400.50 a
	V ₂	400.00 a	375.30a-c	395.00 a
	V ₃	395.00 a	380.10ab	375.20 c
	V ₄	350.00bc	330.30 cd	352.30 d
S ₃	V ₁	375.00ab	340.00b-d	380.20 bc
	V ₂	390.00 a	370.10a-c	385.00 b
	V ₃	330.00 cd	350.00b-d	351.00 d
	V ₄	300.00 d	320.00d	345.80 d
LS		*	*	*
CV (%)		25.09	7.11	1.04
LSD (5%)		31.55	42.45	6.524

Means followed by the same letter (s) do not statistically differ at 5% level tested by DMRT. Here, *and ** indicate significant effect at 5% and 1% level of probability respectively. NS = Non-significant.

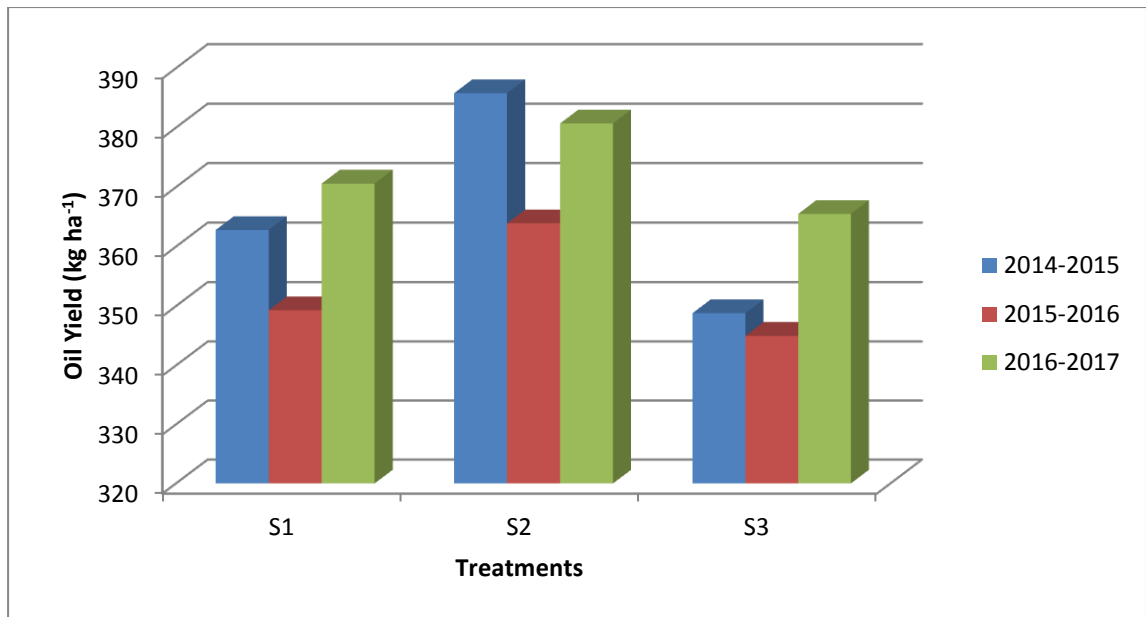

Figure 27. Effect of sowing time on oil yield (kg ha⁻¹) of mustard in the growing seasons of 2014-2015, 2015-2016 and 2016-2017 in research field.

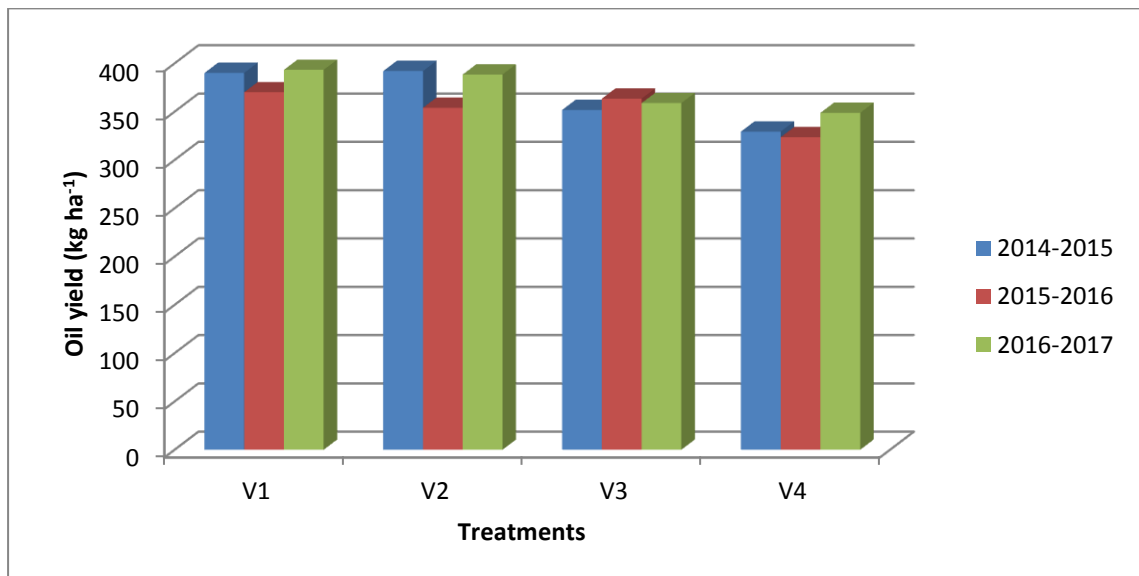

Figure 28. Effect of variety on oil yield (kg ha⁻¹) of mustard in the growing seasons of 2014-2015, 2015-2016 and 2016-2017 in research field.

Experiment 4.3 Effect of sowing time and variety on the yield contributing characters and yield of mustard at farmer's field

This experiment was conducted at farmer's field during the growing season of 2014-2015, 2015-2016 and 2016-2017 with 03 (three) different sowing times and 04 (four) different varieties of mustard selected from experiment 4.1. For each character data were collected at 20, 30 and 40 DAS at harvesting time. The result of the present experiment are shown in Table 18 - 30 and Figures 29 - 54 and have been described below with sub headings as follows:

4.3.1 Plant height (cm)

The plant height of mustard induced by different treatments was recorded at 20, 30 and 40 days after sowing and at harvesting time in the growing seasons of 2014-15, 2015-16 and 2016-17. The values are illustrated in Table 18 and Figures 29-30. At 20 DAS the maximum plant height (16.50 cm, 16.00 cm and 15.67 cm) were observed in treatments S_1V_2 , and S_2V_2 in three different growing seasons and the lowest (10.33 cm, 9.66 cm and 9.66 cm) were found in treatments S_2V_4 and S_3V_1 in 1st, 2nd and 3rd growing seasons which were significantly different from all other treatments (Table 18).

In 03 (three) different growing seasons at 30 DAS treatments S_1V_2 produced the maximum plant height of 37.44 cm, 36.33 cm and 36.00cm whereas the minimum plant height (25.00 cm and 24.00 cm) was produced by treatments S_3V_4 .

At 40 DAS the highest plant (74.00 cm and 73.00 cm) was found in the treatment S_1V_2 and S_2V_2 and the lowest (47.67cm, 46.33 cm and 46.00 cm) was observed in S_3V_3 which was statistically identical with all other

treatments except S_1V_2 , S_2V_2 and S_3V_2 in the growing season of 2014-2015, 2015-2016 and 2016-2017.

At maturity of mustard, in the growing seasons of 2014-2015, 2015-2016 and 2016-2017 the longest plants (104.7 cm, 102.7 cm and 103.0 cm) were found in treatments S_2V_2 , S_3V_2 and S_1V_2 which were significantly different from all other treatments. On the other hand, the shortest plants (75.33 cm, 74.67 cm and 72.67 cm) were found in S_1V_1 and S_2V_1 .

Figure 29 indicates that among three different sowing times treatment S_1 produced the tallest plant at 20 DAS in the growing seasons of 2014-2015, 2015-2016 and 2016-2017. On the other hand the lowest one was found in S_2 and S_3 in the three different growing seasons. At 30 DAS treatment S_1 produced the highest plant height of all seasons and the lowest plant height was found in treatments S_2 and S_3 in 2014-2015, 2015-2016 and 2016-2017. In 2015-16 and 2016-17 it was found statistically non-significant.

At 40 DAS treatment S_2 produced the tallest plant whereas treatment S_3 produced the shortest plants in growing seasons of 2014-15 and 2015-16. In 2016-17 it was found statistically non-significant.

At maturity treatment S_2 produced the tallest plants and treatment S_3 produced the lowest plant height in all three growing seasons.

Plant height was significantly influenced by variety. Among four different varieties, V_2 (BARI Sharisha 11) originated the tallest plant and treatment V_1 originated the shortest plant both at 20, 30 and 40 DAS in all the three growing seasons. At maturity stage of mustard treatment V_2 produced the tallest plant and treatment V_3 produced the shortest plant in all three growing seasons (Figure 30).

These results are more or less similar with the results of Mondal *et al.* (1992) which they observed that variety had significant effect on plant

height. This result is identical with the result of Ali *et al.* (1986) which they found significant variation in plant height in different varieties of mustard and rapeseed.

These results are also in agreement with the results of Mondal and Islam (1993) which they noted that variety had significant effect on plant height. They observed the maximum plant height (134.4 cm) on the variety J-5004, which was identical with SS-75 and was significantly taller than JS-72 and Tori 7.

These results are more or less similar with the results of Majumder and Sandhu (1964) and sing *et al.* (1972) which they noted that the time of sowing had a significant effect on yield of mustard. Thurling (1974a) reported that the flowering time in *B. napus* was short with successive delay in sowing but the time taken in *B. campestris* was longer with middle sowing than early and late sowing.

4.3.2 Number of leaves plant⁻¹

Number of leaves plant⁻¹ of mustard induced by variation of treatments was recorded at 20, 30 and 40 days after sowing and at harvesting time in three growing seasons. The values are illustrated in Table 19 and Figures 31-32. At 20 DAS the maximum number of leaves plant⁻¹ (11.12, 10.25 and 12.25) were observed in treatment S₂V₃ and the lowest (7.25, 8.00 and 8.20) were found in treatment S₃V₃ and S₁V₄ (2014-15).

In 03(three) different growing seasons at 30 DAS treatments S₁V₃ and S₂V₂ produced the highest number of leaves plant⁻¹ of 21.20, 19.53 and 20.07 whereas the lowest leaves plant⁻¹ (12.25, 12.75 and 14.00) was produced by treatments S₃V₁, S₃V₃ and S₃V₄.

Table 18. Combined effect of sowing time and variety on plant height (cm) of mustard at different days after sowing in three growing seasons at farmer's field.

Treatments		Plant height (cm)											
		2014-2015				2015-2016				2016-2017			
Sowing time	Variety	20 DAS	30 DAS	40 DAS	At maturity	20 DAS	30 DAS	40 DAS	At maturity	20 DAS	30 DAS	40 DAS	At maturity
S ₁	V ₁	12.17 bc	27.17ef	49.67 b	75.33 h	11.17 bc	26.67 ef	49.33b	74.67 c	11.33 b-d	26.67 de	48.67 c	73.00 e
	V ₂	16.50a	37.44a	74.00 a	102.3 b	15.67a	36.33a	74.00 a	100.7 a	14.67 a	36.00 a	63.67 b	103.0 a
	V ₃	13.17 b	27.78c-e	49.67 b	80.33 d	12.50 b	27.00 d-f	48.67 b	81.67 b	11.67bc	26.33 de	48.00 c	81.33bc
	V ₄	11.67bc	29.55 cd	48.67 b	84.33 C	10.83 cd	29.33 de	49.00 b	83.33 b	9.833 de	28.67 cd	49.33 c	84.00bc
S ₂	V ₁	11.00 c	26.00 ef	49.33 b	75.67 gh	10.67 cd	26.33 ef	49.00 b	74.67 c	10.67c-e	26.33 de	49.00 c	72.67 e
	V ₂	16.00a	33.78 b	73.33a	104.7 a	16.00 a	33.00 bc	73.33a	102.0 a	15.67 a	31.67 bc	73.00a	101.0 a
	V ₃	11.67 bc	27.33 de	52.33 b	79.33 de	11.33 bc	27.67 de	49.33 b	80.33 b	11.33b-d	26.67 de	46.67c	81.33bc
	V ₄	10.33 c	29.83 c	49.67 b	83.33 c	9.667 d	28.33 de	49.00 b	82.67 b	10.00 de	28.00 c-e	50.00 c	82.67bc
S ₃	V ₁	11.17c	26.55 ef	48.00 b	77.00 fg	10.67 cd	26.33 ef	47.33b	75.00 c	9.667 e	26.67 de	46.33 c	74.67 de
	V ₂	15.17a	37.22a	72.00 a	103.0 b	14.67 a	34.33ab	71.67a	102.7 a	12.67b	34.00 ab	70.33ab	102.7 a
	V ₃	12.00 bc	29.44 cd	47.67 b	78.33 ef	12.33 b	30.00 cd	46.33b	80.00 b	11.33b-d	30.00 b-d	46.00 c	79.00 cd
	V ₄	12.33bc	25.00 f	48.00 b	84.33 C	11.67 bc	24.00 f	48.00b	83.33 b	11.33b-d	24.00e	47.67 c	84.67b
LS		*	**	*	**	*	*	*	*	**	**	*	*
CV (%)		8.12	3.38	4.64	1.38	6.82	6.37	3.43	3.80	5.93	6.41	9.07	4.93
LSD (5%)		1.76	2.24	4.34	0.73	1.38	3.07	3.17	2.64	1.54	4.09	8.18	3.43

Means followed by the same letter (s) do not statistically differ at 5% level tested by DMRT. Here, *and ** indicate significant effect at 5% and 1% level of probability respectively. NS = Non-significant.

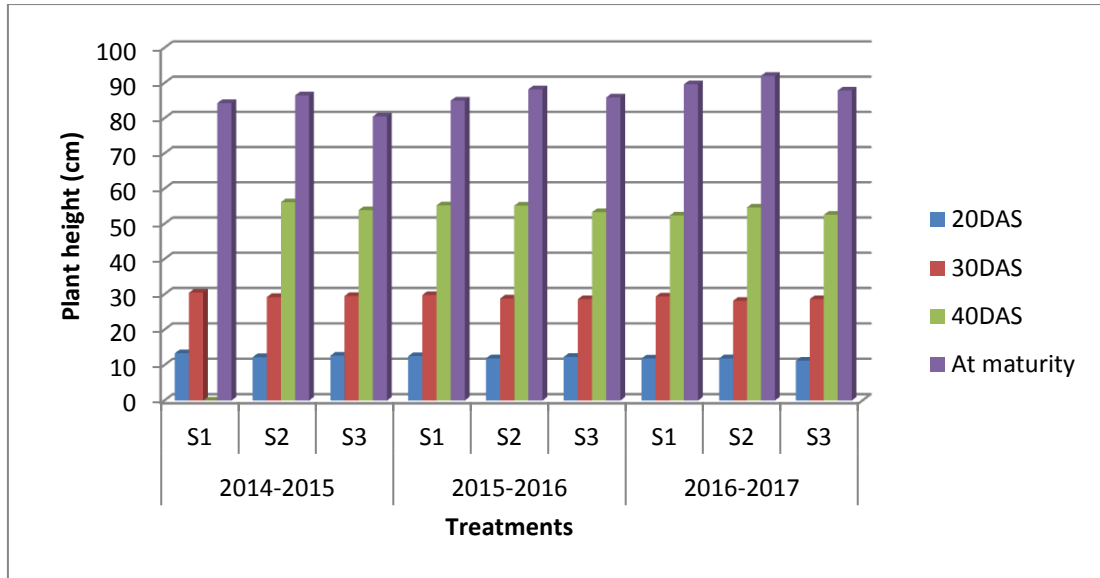

Figure 29. Effect of sowing time on plant height (cm) of mustard at different days after sowing in the growing seasons of 2014-2015, 2015-2016 and 2016-2017 in farmer’s field.

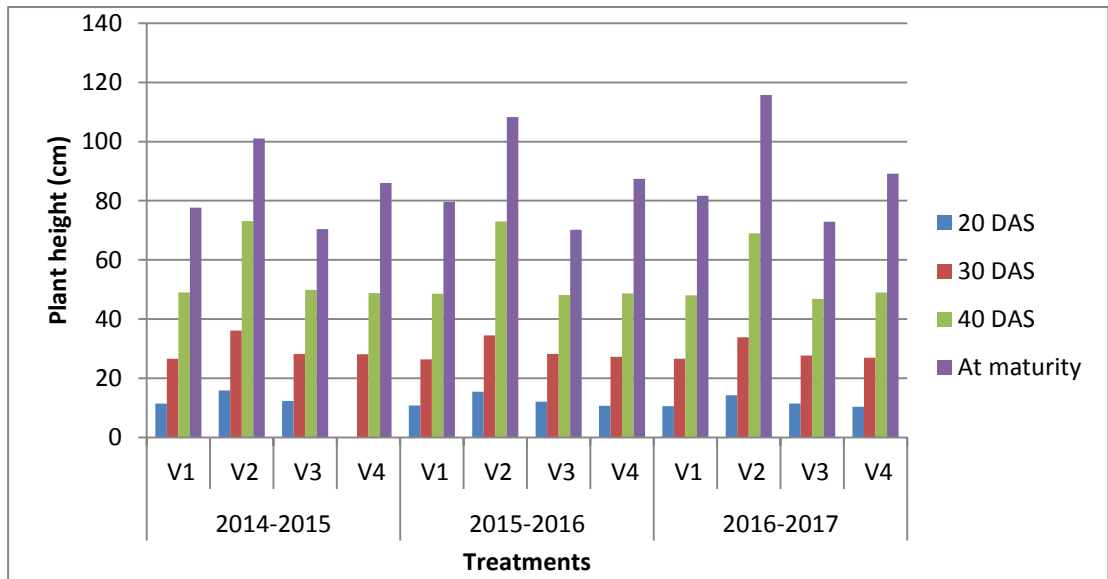

Figure 30. Effect of variety on plant height (cm) of mustard at different days after sowing in the growing seasons of 2014-2015, 2015-2016 and 2016-2017 in farmer’s field.

At 40 DAS the highest number of leaves plant⁻¹ (30.00, 29.00 and 29.28) was found in the treatment S₂V₂ and S₃V₂, whereas the lowest number of leaves plant⁻¹ (19.25, 20.00 and 20.11) was observed in S₃V₄ and S₁V₄ in the growing season of 2014-2015, 2015-2016 and 2016-2017.

At maturity of mustard, in the growing seasons of 2014-2015, 2015-2016 and 2016-2017 the maximum leaves plant⁻¹ (29.00, 30.00 and 30.01) were found in treatment S₃V₂ and S₂V₂ which were significantly different from all other treatments. On the other hand, the minimum leaves plant⁻¹ (20.00 and 18.00) were observed in treatments S₃V₃, S₁V₄ and S₃V₄ (Table 19).

Figure 31 indicated the number of leaves plant⁻¹ influenced significantly by sowing time. Treatment S₂ produced the maximum number of leaves plant⁻¹ whereas treatment S₃ produced the minimum both at 20, 30, 40 DAS and at maturity in all three growing seasons.

Varietal effect of number of leaves plant⁻¹ was presented in Figure 32. The maximum number of leaves plant⁻¹ were observed in treatment V₂ and the minimum were found in V₄ both at 20, 30, 40 DAS and at maturity in all the growing seasons of 2014-15, 2015-16 and 2016-17.

These result are in agreement with the result of Hussain *et al.* (2006) which they conducted a field experiment during 1999-2000 to 2001-02 to evaluate the effect of sowing date (25 September, 10 October and 25 October) on the performance of Indian mustard. The growth parameters tested were: plant height and green leaf number at 30 and 60 days after sowing, and at harvest, number of primary, secondary and tertiary branches plant⁻¹; siliqua plant⁻¹; siliqua length; seeds siliqua⁻¹; days to 75% flowering; days to maturity; seed yield plant⁻¹; 1000-seeds weight; and harvest index. All growth and yield parameters were higher under 25 September sowing than later sowing dates.

Table 19. Combined effect of sowing time and variety on the number of leaves plant⁻¹ of mustard at different days after sowing in three growing seasons at farmer's field.

Treatments		Number of leaves plant ⁻¹											
		2014-2015				2015-2016				2016-2017			
Sowing time	Variety	20 DAS	30 DAS	40 DAS	At maturity	20 DAS	30 DAS	40 DAS	At maturity	20 DAS	30 DAS	40 DAS	At maturity
S ₁	V ₁	9.00ab	16.20 d	21.00ef	23.25d	9.00 c	14.10 de	21.00ef	19.86 f	9.20e	15.20 bc	21.00 de	20.00 c
	V ₂	11.00 a	15.20 ef	25.00 c	26.00 bc	9.25bc	15.00c-e	25.00 c	26.17 d	10.80bc	17.80a-c	27.00a-c	27.00ab
	V ₃	9.25ab	16.00 de	27.50 b	27.00ab	10.10 a	19.53 a	27.10 b	29.03ab	11.25 b	18.10a-c	28.20 ab	29.03ab
	V ₄	9.00 ab	13.00 h	20.00fg	20.15 f	8.00 d	14.10 de	20.00 f	18.00g	8.20 f	15.20 bc	21.50 de	20.00c
S ₂	V ₁	9.95 ab	15.20ef	25.00 c	27.00 ab	9.00c	18.00a-c	25.00 c	20.00f	9.28 de	18.07a-c	25.25 bc	23.00bc
	V ₂	10.00 a	21.20 a	30.00 a	22.67 de	10.10a	18.25 ab	27.20 b	30.00 a	11.30 b	20.07 a	29.28a	30.10a
	V ₃	11.12 a	14.00g	25.00 c	26.00 bc	10.25a	17.75a-c	24.80 c	27.20cd	12.25 a	19.00ab	26.26a-c	28.22ab
	V ₄	11.50 a	18.25 b	23.00 d	25.20 cd	10.00ab	18.00a-c	21.1 ef	24.1be	10.20 cd	18.00a-c	25.15 bc	25.00 -c
S ₃	V ₁	9.85 ab	12.25h	22.10de	24.00 cd	9.98 ab	16.00b-d	23.13 d	23.00e	10.12c-e	16.25a-c	24.22 cd	23.20bc
	V ₂	11.00 a	17.00 c	30.25 a	29.00 a	10.00ab	15.30b-e	29.00 a	28.19bc	9.25 de	17.90a-c	29.07 a	30.00 a
	V ₃	7.25 b	15.25ef	21.00ef	20.00 f	8.00 d	12.75 e	22.20de	26.09 d	8.27f	14.32 c	24.17 cd	25.12a-c
	V ₄	8.90 ab	14.95 f	19.25 g	20.50 ef	9.00c	14.00 de	20.00 f	20.00f	9.90 c-e	14.00c	20.11 e	20.00c
LS		*	*	*	*	*	*	*	*	*	*	*	*
CV (%)		7.69	5.24	6.45	8.49	5.34	8.95	7.28	8.15	6.25	9.68	1.24	12.35
LSD (5%)		2.39	0.78	1.36	2.39	0.73	2.74	1.26	1.36	0.88	3.69	3.30	5.42

Means followed by the same letter (s) do not statistically differ at 5% level tested by DMRT. Here, *and ** indicate significant effect at 5% and 1% level of probability respectively. NS = Non-significant.

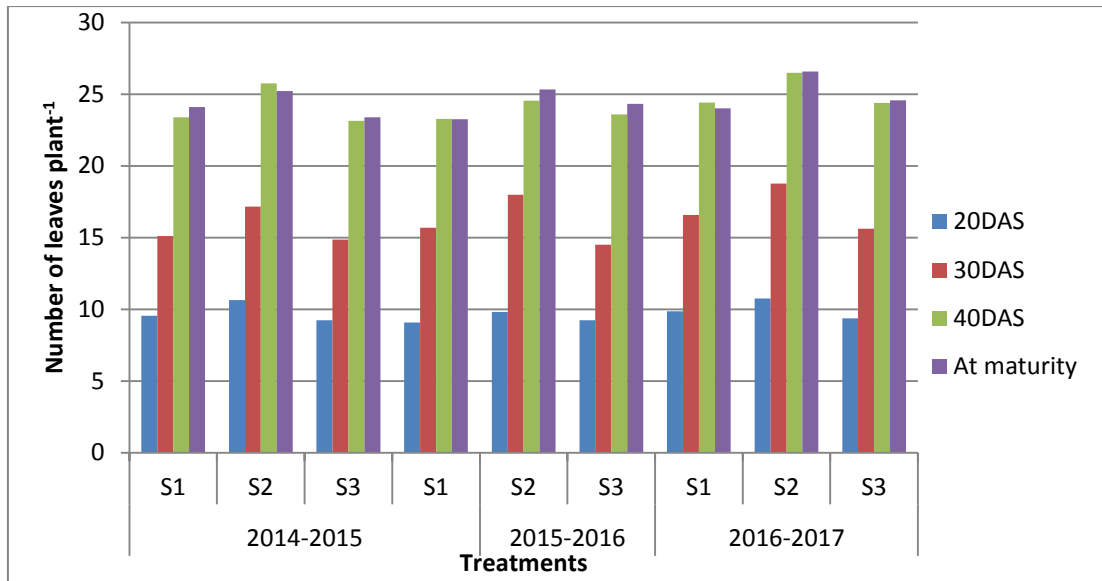

Figure 31. Effect of sowing time on number of leaves plant⁻¹ of mustard at different days after sowing in the growing seasons of 2014-2015, 2015-2016 and 2016-2017 in farmer's field.

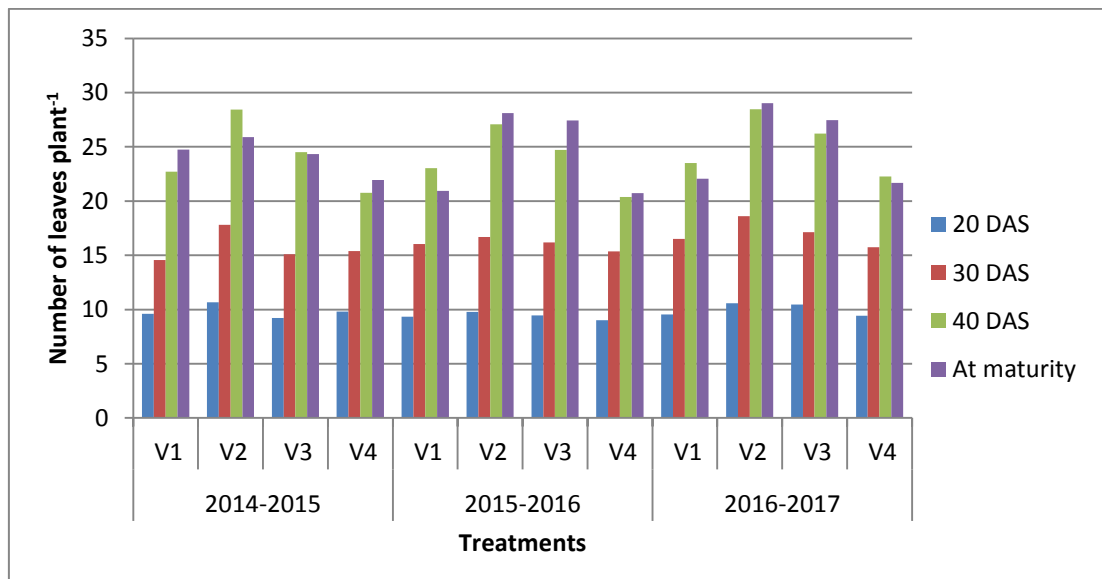

Figure 32. Effect of variety on number of leaves plant⁻¹ of mustard at different days after sowing in the growing seasons of 2014-2015, 2015-2016 and 2016-2017 in farmer's field.

4.3.3 Number of branches plant⁻¹

The number of branches plant⁻¹ of mustard induced by different treatments was recorded at 20, 30 and 40 days after sowing and at harvesting time in three growing seasons. The values are illustrated in Table 20 and Figures 33-34.

At 20 days after sowing (DAS) the highest number of branches plant⁻¹ (1.67) was observed in treatment S₁V₃ and the lowest was in (0.33 and 0.67) in treatment S₃V₂ in the growing seasons of 2014-15 and 2015-16. In 2016-17 it was found to statistically non-significant (Table 20)

In 03(three) different growing seasons at 30 DAS treatments S₂V₁ and S₃V₁ produced the maximum branches plant⁻¹ (3.00, 2.67 and 2.67) whereas the minimum branches plant⁻¹ (0.67) was produced by treatments S₃V₂ and S₃V₄ in all three growing seasons.

At 40 DAS the highest branches plant⁻¹ (6.33, 6.33 and 6.00) was found in the treatment S₁V₁ whereas the lowest branches plant⁻¹ (2.00 and 1.67) was observed in S₁V₂, S₁V₄, S₂V₂, S₂V₄ and S₃V₂ in the growing season of 2014-2015, 2015-2016 and 2016-2017.

At maturity of mustard, in the growing seasons of 2014-2015, 2015-2016 and 2016-2017 the maximum branches plant⁻¹ (12.00, 11.33 and 10.67) were found in treatments S₂V₁ which were significantly different from all other treatments. Any other way, the minimum branches plant⁻¹ (3.00) was observed in treatments S₂V₃, S₂V₄ and S₃V₄.

Figure 33 indicated that the effect of sowing time on number of branches plant⁻¹ statistically non-significant.

Number of branches plant⁻¹ was significantly formed by variety. The results are shown in figure 34. Among four different varieties, V₁ (BARI Sharisha 9) produced the highest number of branches plant⁻¹ both at 20, 30, 40 DAS and at maturity in all the three growing seasons. The minimum number of branches plant⁻¹ was found in treatment V₂ at 20 and 30 DAS (2014-15); 20, 30 and 40 DAS (2015-16 and 2016-17); V₃ at maturity (2015-16) and V₄ at 40 DAS and at maturity (2014-15) and at maturity in 2016-2017 (Figure 34), which were statistically different from all other treatments.

These results support the result of Razzaque *et al.* (2002) which they demonstrated the effect of time sowing on the achievement of mustard varieties in the southern region of Bangladesh. This result is similar to the result of Hossain *et al.* (1996) who state that the varieties were statistically variant with respect to number of primary branches plant⁻¹. The highest number of primary branches was recorded in the Hyola-401 (5.0) and the lowest number was recorded in Semu-249/84. Khaleque (1989) observed 3.9 and 3.1 branches plant⁻¹ in TS-72 and Sonali Sarisha respectively.

4.3.4 Days to 50% flowering

The combined effect of sowing time and variety on days to 50% flowering of mustard was recorded in the different growing seasons. The maximum days required for 50% flowering (42.67) of mustard was found in treatment S₁V₁ which was statistically identical with S₂V₂ whereas the lowest days (26.33) were found in S₂V₁ which was statistically similar with S₁V₁ and S₃V₁ in the growing season of 2014-15 (Table 21). In 2nd and 3rd growing seasons days required for 50% flowering found highest (42.00 and 41.33) in treatments S₁V₂ and S₂V₂ and the lowest days (27.33 and 28.00) was found in treatments S₂V₁ and S₃V₁.

Table 20. Combined effect of sowing time and variety on the number of branches plant⁻¹ of mustard at different days after sowing in three growing seasons at farmer's field.

Treatments		Number of branches plant ⁻¹											
		2014-2015				2015-2016				2016-2017			
Sowing time	Variety	20 DAS	30 DAS	40 DAS	At maturity	20 DAS	30 DAS	40 DAS	At maturity	20 DAS	30 DAS	40 DAS	At maturity
S ₁	V ₁	1.00a-c	2.33ab	6.33a	11.33a	1.33ab	2.00a-c	6.33a	10.33a	1.00a	1.67a-c	6.00a	9.33a
	V ₂	1.00a-c	1.33cd	2.33c	4.33bc	1.00ab	1.00cd	2.00d	4.00bc	1.33a	1.33bc	2.00c	4.33b
	V ₃	1.67 a	1.00cd	2.33c	4.33bc	1.67a	1.00cd	3.00b-d	4.00bc	2.00a	1.00bc	3.00 bc	4.33b
	V ₄	0.67bc	1.33cd	2.00c	3.33d	1.00ab	1.67a-d	2.00d	4.00bc	1.00a	1.67a-c	2.00 c	4.00b
S ₂	V ₁	1.33 ab	2.33ab	5.33b	12.00a	1.33ab	2.67 a	5.00ab	11.33a	1.33a	2.67a	4.67ab	10.67a
	V ₂	1.00a-c	0.67d	2.00c	3.33d	1.67a	1.00 cd	1.67d	3.33bc	1.33a	1.00bc	2.00 c	3.33b
	V ₃	1.33 ab	1.33cd	2.33c	3.33d	1.00ab	1.00 cd	2.33cd	3.00c	1.67a	1.00bc	2.33 c	3.00b
	V ₄	0.67 bc	1.67bc	2.00c	3.67cd	1.33ab	1.33 b-d	2.00 d	3.00c	1.00a	1.33a-c	2.00 c	3.00b
S ₃	V ₁	1.33 ab	3.00a	5.33b	11.33a	1.33ab	2.33 ab	4.33a-c	10.33a	1.67a	2.33ab	4.00a-c	10.33a
	V ₂	0.33 c	0.67d	2.67c	4.67b	0.67b	1.00 cd	2.33 cd	4.67b	1.00a	0.67c	2.00 c	3.67b
	V ₃	1.33 ab	1.33cd	2.33c	3.33d	1.33ab	1.33 b-d	2.33 cd	3.67bc	1.33a	1.00bc	2.33 c	3.33b
	V ₄	1.33ab	1.00cd	2.67c	3.00d	1.00ab	0.67 d	3.00b-d	4.00bc	1.00a	1.00bc	2.67 bc	3.33b
LS		*	*	*	*	*	*	*	*	*	*	*	*
CV (%)		10.82	15.10	9.22	10.95	45.98	12.32	13.84	30.85	50.78	39.02	16.97	45.05
LSD (5%)		0.85	0.83	0.80	0.87	0.95	1.11	1.96	1.28	1.19	1.19	1.93	1.50

Means followed by the same letter (s) do not statistically differ at 5% level tested by DMRT. Here, *and ** indicate significant effect at 5% and 1% level of probability respectively. NS = Non-significant.

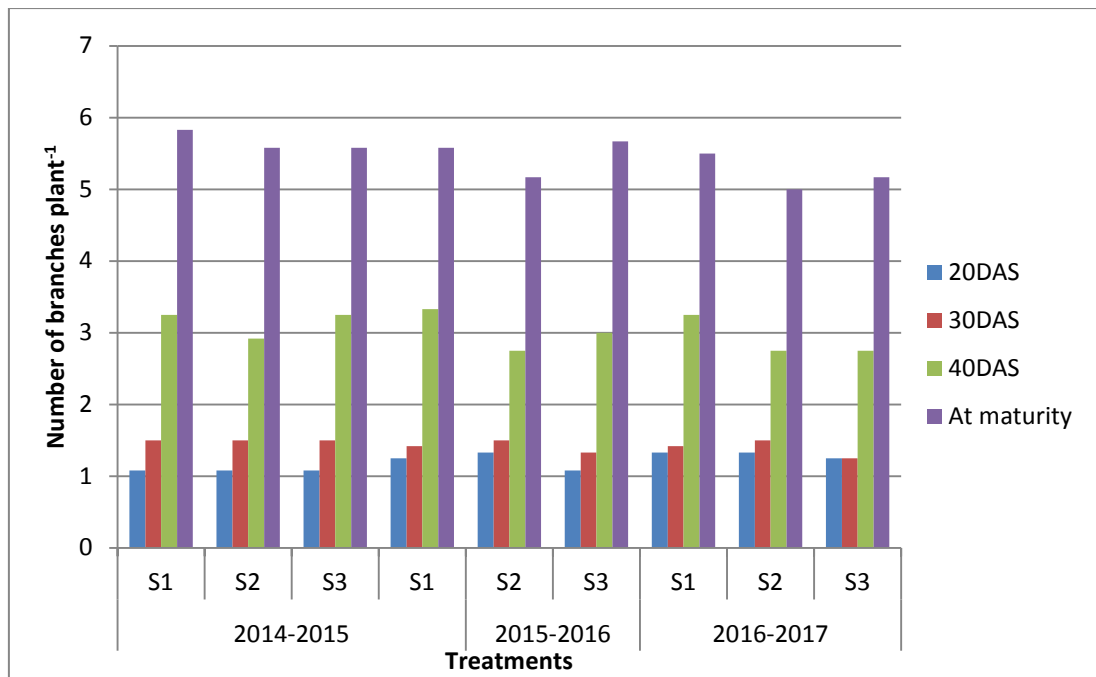

Figure 33. Effect of sowing time on the number of branches plant⁻¹ of mustard at different days after sowing in the growing seasons of 2014-2015, 2015-2016 and 2016-2017 in farmer's field.

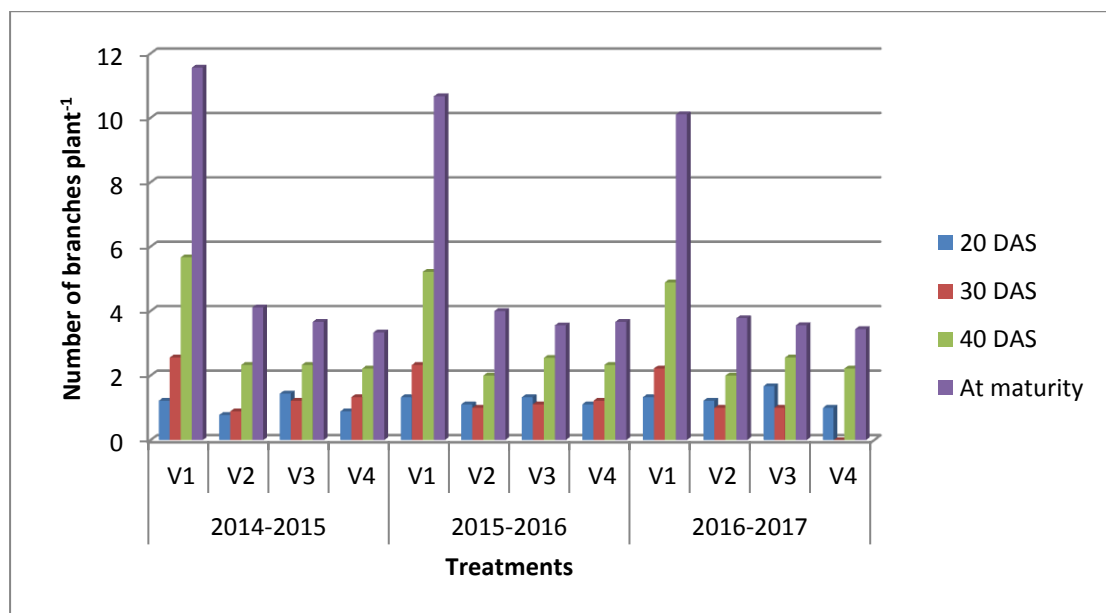

Figure 34. Effect of variety on the number of branches plant⁻¹ of mustard at different days after sowing in the growing seasons of 2014-2015, 2015-2016 and 2016-2017 in farmer's field.

The effect of sowing time on days to 50% flowering was observed statistically non-significant (Figure 35) at three different growing seasons.

Figure 36 indicated that different variety influenced significantly on days to 50% flowering. Treatment V₂ produced the maximum days to 50% flowering whereas treatment V₁ required the lowest days in all three growing seasons which were significantly different from all other treatments.

These results are more or less similar with the results of Raquibullah *et al.* (2006) where they conducted a field experiment at the Central Research Station of BARI, Joydebpur, Gazipur, Bangladesh, for two consecutive years (1998-99 and 1999-2000) with *B. campestris* (cultivars Tori 7, TS-72, SS-75, BARI Sarisha 6, BARI Sarisha 9 and BARI Sarisha 12), *B. juncea* (cultivars Rai-5, Daulat, BARI Sarisha 10 and BARI Sarisha 11), and *B. napus* (cultivars BARI Sarisha-7, BARI Sarisha 8 and Nap-248) and three sowing dates, viz., 20 October, 11 November and 5 December to study the performance of rapeseed-mustard cultivars for early and late sowing situation. They observed that sowing date and variety has significantly influenced plant height, siliqua plant⁻¹, seeds siliqua⁻¹, seed yield, stover dry weight, Days to 50% flowering, maturity and oil content of seed in both the years. Days to 50% flowering and maturity were different among the different planting time in the growing season of the experimental area.

Table 21. Combined effect of sowing time and variety on days to 50% flowering of mustard in three growing seasons at farmer's field.

Treatments		Days to 50% flowering		
Sowing time	Variety	2014-2015	2015-2016	2016-2017
S ₁	V ₁	28.67 e	29.33 bc	30.67 b
	V ₂	42.67 a	42.00 a	40.67 a
	V ₃	32.67 d	32.00 b	31.00 b
	V ₄	35.67 b	33.33 b	32.67 b
S ₂	V ₁	28.33 e	27.33 c	28.00 b
	V ₂	42.33 a	41.67 a	41.33 a
	V ₃	32.33 d	32.67 b	32.33 b
	V ₄	36.00 b	33.33 b	33.00 b
S ₃	V ₁	28.67e	27.33 c	29.00 b
	V ₂	42.00 a	40.67 a	40.67 a
	V ₃	32.67 d	30.67 bc	30.00 b
	V ₄	34.33 c	32.00 b	31.33 b
LS		*	*	*
CV (%)		2.00	6.41	8.13
LSD (5%)		1.18	3.64	4.60

Means followed by the same letter (s) do not statistically differ at 5% level tested by DMRT. Here, *and ** indicate significant effect at 5% and 1% level of probability respectively. NS = Non-significant.

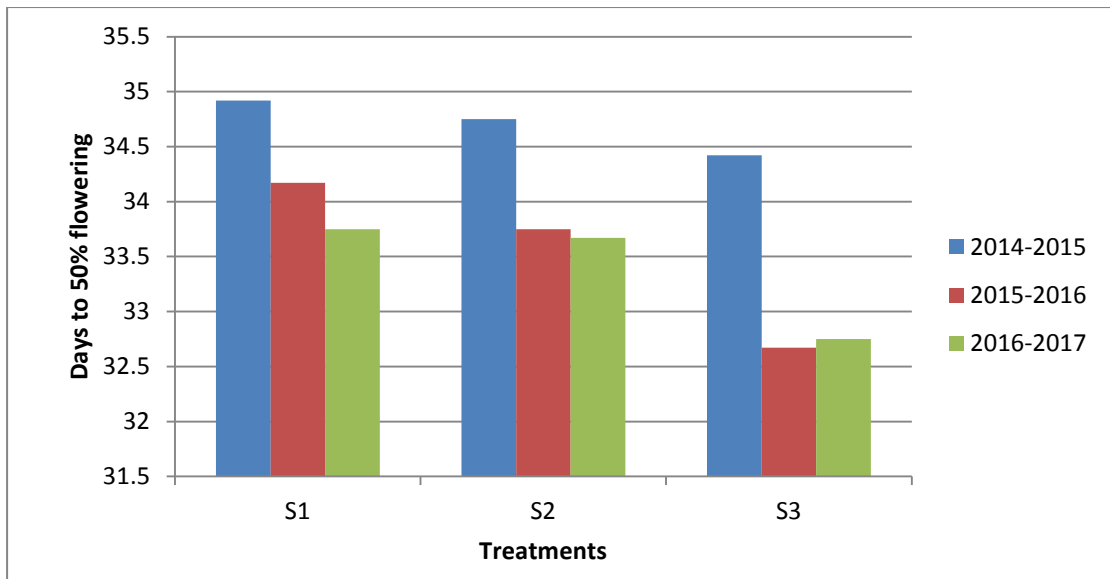

Figure 35. Effect of sowing time on days to 50% flowering of mustard in the growing seasons of 2014-2015, 2015-2016 and 2016-2017 in farmer’s field.

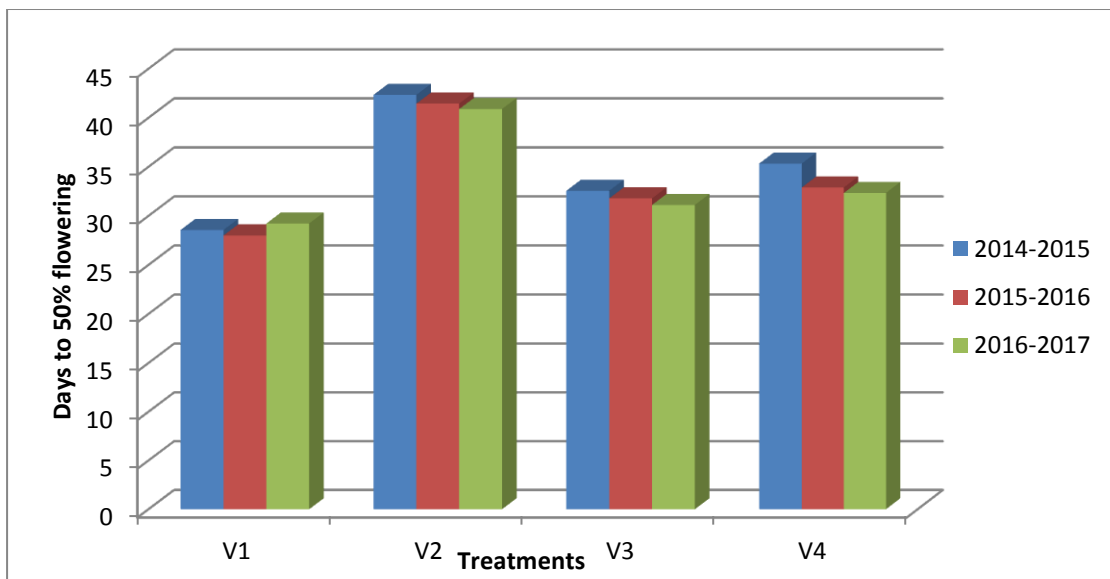

Figure 36. Effect of variety on days to 50% flowering of mustard in the growing seasons of 2014-2015, 2015-2016 and 2016-2017 in farmer’s field.

4.3.5 Days to maturity

Combined effect of sowing time, variety on days required to maturity of mustard was observed significant. In the growing season of 2014-15 the maximum days required (104.70) for days to maturity in treatment S_2V_2 whereas the minimum days (75.33) was found in S_1V_1 which were significantly different from all other treatments (Table 22). Treatments S_3V_2 and S_1V_2 required the higher days for days to maturity (102.70 and 103.00) and treatment S_2V_2 required lowest days (74.67 and 72.64) which were statistical similar with treatments S_1V_1 and S_3V_1 in 2nd and 3rd growing seasons.

The effect of sowing time on days to maturity of mustard in three different growing seasons found statistically non-significant (Figure 37).

Figure 38 showed that among four different varieties, treatment V_2 required the maximum days to maturity whereas treatment V_1 required the minimum days in the growing seasons of 2014-15, 2015-16 and 2016-17.

Results are similar with the results of Ghanbahadur *et al.* (2005) which they conducted a field experiment during the winter season of 1999-2001 to determine the effects of sowing dates (15 and 30 November) on the growth and yield of mustard. During the early stages, the relative growth rate and net assimilation rate were significantly higher with 15 November sowing compared to 30th November.

Results are in agreement with the results of Hussain *et al.* (2006) where observed that maturity was depends on various parameters and they conducted a field experiment during 1999-2000 to 2001-02 to evaluate the effect of sowing date (25 September, 10 October and 25 October) on the performance of Indian mustard. The growth parameters tested were: plant height and green leaf number at 30 and 60 days after sowing, and at

harvest; number of primary, secondary and tertiary branches plant⁻¹; siliqua plant⁻¹; siliqua length; seeds siliqua⁻¹; days to 50% flowering; days to maturity; seed yield plant⁻¹; 100-seed weight; and harvest index. All growth and yield parameters were higher under 25 September sowing than later sowing dates.

Table 22. Combined effect of sowing time and variety on days to maturity of mustard in three growing seasons at farmer's field.

Treatments		Days to maturity		
Sowing time	Variety	2014-2015	2015-2016	2016-2017
S ₁	V ₁	75.33 h	74.67 c	73.00 e
	V ₂	102.30 b	100.70a	103.00 a
	V ₃	80.33d	81.67 b	81.33bc
	V ₄	84.33 c	83.33 b	84.00bc
S ₂	V ₁	75.67 gh	74.67 c	72.67 e
	V ₂	104.70 a	102.00a	101.00 a
	V ₃	79.33 de	80.33 b	81.33bc
	V ₄	83.33 c	82.67 b	82.67 bc
S ₃	V ₁	77.00 fg	75.00 c	74.67 de
	V ₂	103.00 b	102.70a	102.70 a
	V ₃	78.33 ef	80.00 b	79.00 cd
	V ₄	84.33 c	83.33 b	84.67b
LS		**	*	*
CV (%)		0.73	2.64	3.43
LSD (5%)		1.38	3.80	5.42

Means followed by the same letter (s) do not statistically differ at 5% level tested by DMRT. Here, *and ** indicate significant effect at 5% and 1% level of probability respectively. NS = Non-significant.

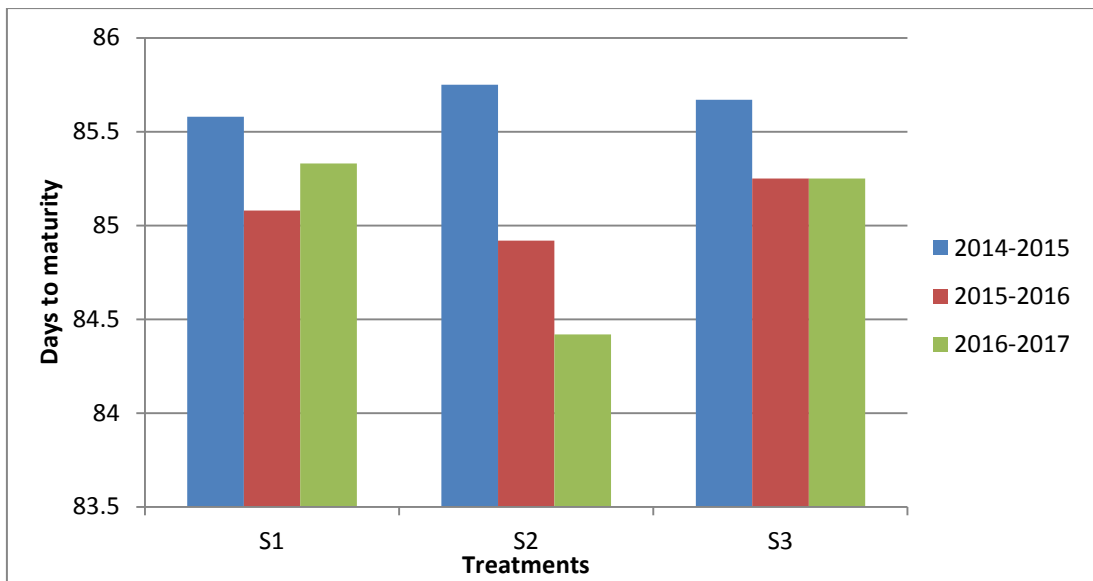

Figure 37. Effect of sowing time on days to maturity of mustard in the growing seasons of 2014-2015, 2015-2016 and 2016-2017 in farmer's field.

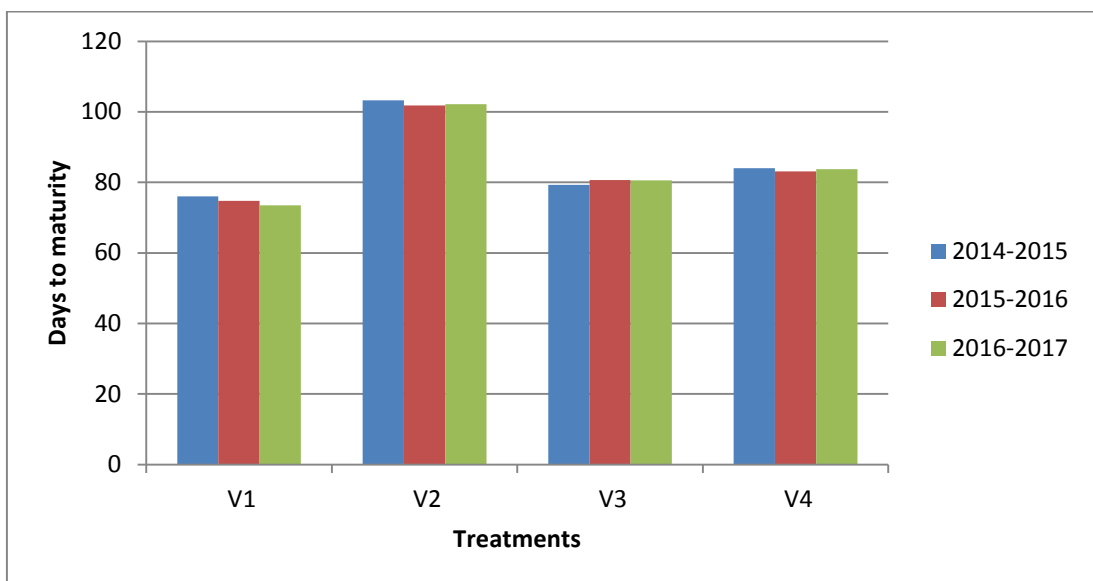

Figure 38. Effect of variety on maturity of mustard at different days after sowing in the growing seasons of 2014-2015, 2015-2016 and 2016-2017 in farmer's field.

4.3.6 Pod length (cm)

Pod length of mustard was significantly influenced by sowing time and variety. Required data are presented in Table 23 and Figures 39-40. In the growing season of 2014-15, the highest pod length (5.00) was found in treatment S_2V_4 which was statistically identical with S_1V_1 , S_1V_3 , S_2V_2 and S_3V_1 whereas the lowest pod length (3.85) was found in treatment S_2V_3 which was statistically identical with S_1V_1 , S_1V_2 , S_1V_4 , S_2V_1 , S_3V_2 , S_3V_3 and S_3V_4 . In 2nd and 3rd growing seasons pod length found statistically non-significant (Table 23).

Pod length of mustard influenced by sowing time and data was found also statistically non-significant (Figure 39).

Figure 40 showed that pod length of mustard influenced by different variety was statistically non-significant in the growing seasons of 2014-15 and 2015-16. In 2016-17 treatment V_1 produced longest pod and V_3 produced the shortest pod which was significantly different from all other treatments except V_1 .

This results support the results of Hossain *et al.* (1996) which they found the longest pod (8.07 cm) in BLN-900 and the shortest (4.83 cm) in Hyola-401. Results are in similar with the results of Jahan and Zakaria (1997) which they noticed that the shortest pod length (4.62 cm) was found in the hybrid Semu-249/84 which was identical to those of Semu-DNK_89/218, AGH-7 and Tori 7. The longest pod (8.07 cm) was found in BLN-900 and Hyola-401.

Table 23. Combined effect of sowing time and variety on pod length (cm) of mustard in three growing seasons at farmer's field.

Treatments		Pod length(cm)		
Sowing time	Variety	2014-2015	2015-2016	2016-2017
S ₁	V ₁	4.450ab	4.890 a	5.000 a
	V ₂	4.000b	4.000 a	4.100 a
	V ₃	4.950a	4.150 a	4.250 a
	V ₄	3.950 b	4.250 a	4.500 a
S ₂	V ₁	4.100b	4.500 a	4.980 a
	V ₂	4.950a	4.200 a	4.700 a
	V ₃	3.850 b	4.000 a	4.500 a
	V ₄	5.000a	4.970 a	5.000 a
S ₃	V ₁	4.970a	5.000 a	5.000 a
	V ₂	4.500ab	4.200 a	4.000 a
	V ₃	4.000b	4.000 a	3.900 a
	V ₄	4.200b	3.950 a	4.000 a
LS		*	NS	NS
CV (%)		9.01	14.16	8.25
LSD (5%)		0.6105	1.219	1.197

Means followed by the same letter (s) do not statistically differ at 5% level tested by DMRT. Here, *and ** indicate significant effect at 5% and 1% level of probability respectively. NS = Non-significant.

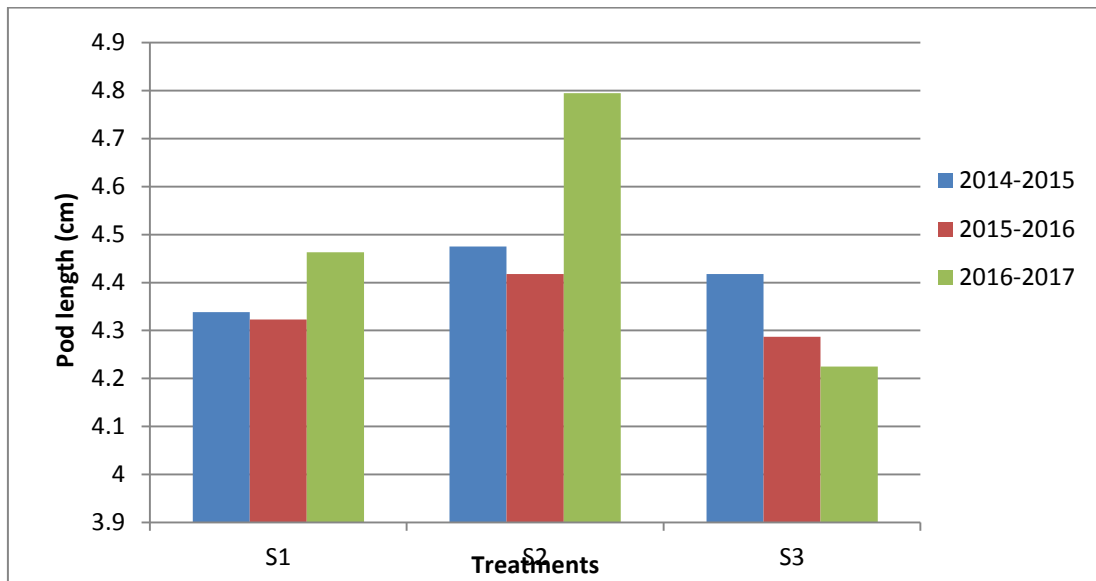

Figure 39. Effect of sowing time on pod length (cm) of mustard in the growing seasons of 2014-2015, 2015-2016 and 2016-2017 in farmer's field.

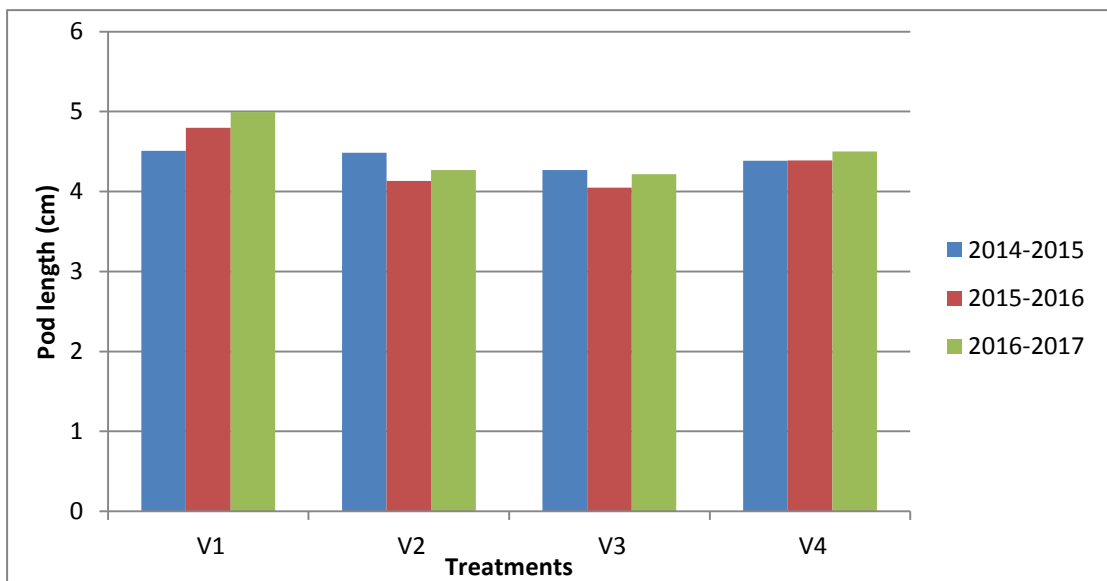

Figure 40. Effect of variety on pod length (cm) of mustard in the growing seasons of 2014-2015, 2015-2016 and 2016-2017 in farmer's field.

4.3.7 Number of pods plant⁻¹

Number of pods plant⁻¹ of mustard was varied significantly due to combined effect of sowing time and variety and it was shown in Table 24 and Figures 41-42.

Table 24 shows that in the three different growing seasons the maximum number of pods plant⁻¹ (130.00, 125.00 and 132.20) was observed in treatment S₂V₂ which were statistically different from all other treatments. Any other way, the minimum number of pods plant⁻¹ (60.00, 48.82 and 64.13) was found in treatments S₃V₁ which were statistically different from all other treatments.

Among the different sowing times treatment S₂ produced the maximum number of pods plant⁻¹ whereas treatment S₃ produced the lowest which were significantly different from all other treatments in all three growing seasons (Figure 41).

Figure 42 indicated that treatment V₂ gave the highest number of pods plant⁻¹ and treatment V₃ gave the lowest in all three growing seasons which were statistically different from all other treatments.

This result support the result of Kumar *et al.* (2004) which they described that maximum pods plant⁻¹ were recorded when the crop was planted on 21 October. These result are in identical with the result of Sharma *et al.* (2006) which they found that pods plant⁻¹ were maximum in the crop sown on 22 and 29 October compared to early and late sowing of 6 October and 12 November respectively.

This finding support the findings of Buttar and Aulakh (1999) which they observed that pods plant⁻¹ were higher in 25 October (1st date) sowing. This was cause of the fact that under earlier sown crop, the

temperature and all other climatological parameters played a major role for growth and yield attributes.

These results are more or less similar with the result of Brar *et al.* (1998) which they described that early sown crop produced higher number of pods plant⁻¹ in comparison to late sowing. Sowing at 30 October and 15 November were at par with each other but further delay in sowing caused significant reduction in number of pods plant⁻¹.

Table 24. Combined effect of sowing time and variety on number of pods plant⁻¹ of mustard in three growing seasons at farmer's field.

Treatments		Number of pods plant ⁻¹		
Sowing time	Variety	2014-2015	2015-2016	2016-2017
S ₁	V ₁	84.00 c	80.29 c-e	84.25 cd
	V ₂	110.0 b	105.0 b	112.2b
	V ₃	75.00d	62.75 fg	66.85f
	V ₄	65.00ef	70.23 d-f	72.37 ef
S ₂	V ₁	88.00 c	87.00 c	78.10 de
	V ₂	130.0 a	125.0 a	132.2 a
	V ₃	75.00 d	70.00 d-f	70.10ef
	V ₄	73.00 d	68.20 ef	71.00 ef
S ₃	V ₁	60.00f	48.82 g	64.13f
	V ₂	85.00c	85.25 cd	90.00 c
	V ₃	67.00 d-f	60.00 fg	78.00 de
	V ₄	68.00 de	75.98c-f	66.15f
LS		*	*	*
CV (%)		5.07	7.91	27.84
LSD (5%)		7.30	14.41	9.12

Means followed by the same letter (s) do not statistically differ at 5% level tested by DMRT. Here, *and ** indicate significant effect at 5% and 1% level of probability respectively. NS = Non-significant.

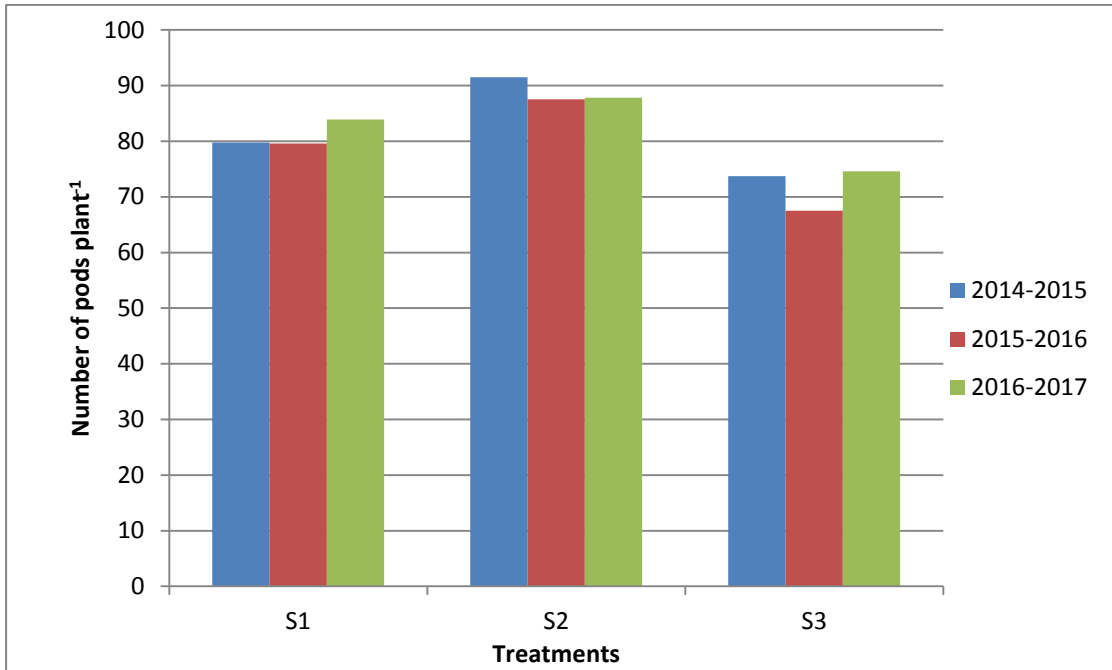

Figure 41. Effect of sowing time on number of pods plant⁻¹ of mustard in the growing seasons of 2014-2015, 2015-2016 and 2016-2017 in farmer's field.

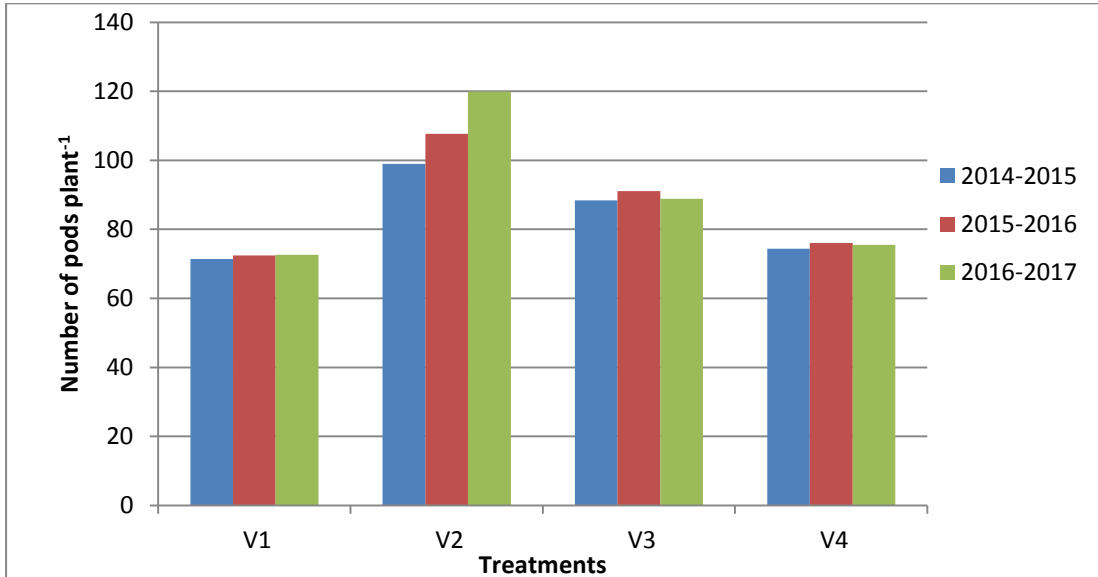

Figure 42. Effect of variety on number of pods plant⁻¹ of mustard in the growing seasons of 2014-2015, 2015-2016 and 2016-2017 in farmer's field.

4.3.8 Number of seeds pod⁻¹

There were found significant effect of sowing time and variety on number of seeds pod⁻¹ of mustard in the growing seasons of 2014-15, 2015-16 and 2016-17. In Table 25 it was observed that treatment S₁V₃ produced the maximum number of seeds pod⁻¹ (27.00, 28.05 and 29.00) which were statistically similar with S₃V₃ and S₂V₃ whereas the minimum number of seeds pod⁻¹ (10.00, 9.66 and 9.66) were found in treatment S₂V₂ which were statistically similar with S₁V₂ and S₃V₂ in all the three growing seasons.

In case of sowing time, number of seeds pod⁻¹ was found statistically non-significant in the growing seasons of 2014-15 and 2016-17 (Figure 43). In the growing season of 2015-16, treatment S₁ originated the highest number of seeds pod⁻¹ and treatment S₂ gave the lowest which were statistically different from all the treatments.

Number of seeds pod⁻¹ was significantly changed by variety (Figure 44). Treatment V₃ originated the maximum number of seeds pod⁻¹ and treatment V₂ gave the minimum which were significantly different from all other treatments in all three growing seasons.

This finding support the findings of Mondal *et al.* (1992) observed that the highest number of seeds pod⁻¹ (27.6) in SS-75 which was significantly variant from all other varieties. The lowest number of seeds pod⁻¹ (13.8) was found in J-5004.

These results also support the results of Jahan and Zakaria (1997) which they demonstrated among the entries Dhali produced the maximum number of seeds pod⁻¹ (26.13) which was at par with Sonali (23.5) and Jatorai (22.8). The minimum number of seeds pod⁻¹ (18.0) was found in

Tori 7 which was at par with in Sampad (20.0), Hyole 401 (20.3), BARI Sarisha 7 (20.5), AGA-95-21 (20.7) and BARI Sarisha 8 (21.6).

This result also support the result of Das *et al.* (1999) which they reported that MM-7 (Mutant) produced the highest number of seeds pod⁻¹ (29.2) followed by MM-20 (Mutant) (28.0) and BINA Sarisha 4 (27.8) at Dinajpur.

Table 25. Combined effect of sowing time and variety on number of seeds pod⁻¹ of mustard in three growing seasons at farmer's field.

Treatments		Number of seeds pod ⁻¹		
Sowing time	Variety	2014-2015	2015-2016	2016-2017
S ₁	V ₁	15.33 c	15.33 c	14.00 de
	V ₂	11.67 d	11.00 e	12.00 fg
	V ₃	27.00 a	28.05 a	29.00 a
	V ₄	19.67 b	20.00 b	18.67 c
S ₂	V ₁	13.00 cd	13.33 d	13.00 ef
	V ₂	10.00 d	9.667 e	9.667 h
	V ₃	27.10 a	28.00 a	29.10 a
	V ₄	22.33 b	21.00 b	21.00 b
S ₃	V ₁	15.33 c	16.00 c	15.00 d
	V ₂	10.33 d	10.00 e	11.00 gh
	V ₃	27.00 a	27.90 a	29.50 a
	V ₄	20.67 b	21.00 b	21.00 b
LS		*	*	*
CV (%)		8.64	4.24	5.93
LSD (5%)		2.88	1.35	1.88

Means followed by the same letter (s) do not statistically differ at 5% level tested by DMRT. Here, *and ** indicate significant effect at 5% and 1% level of probability respectively. NS = Non-significant.

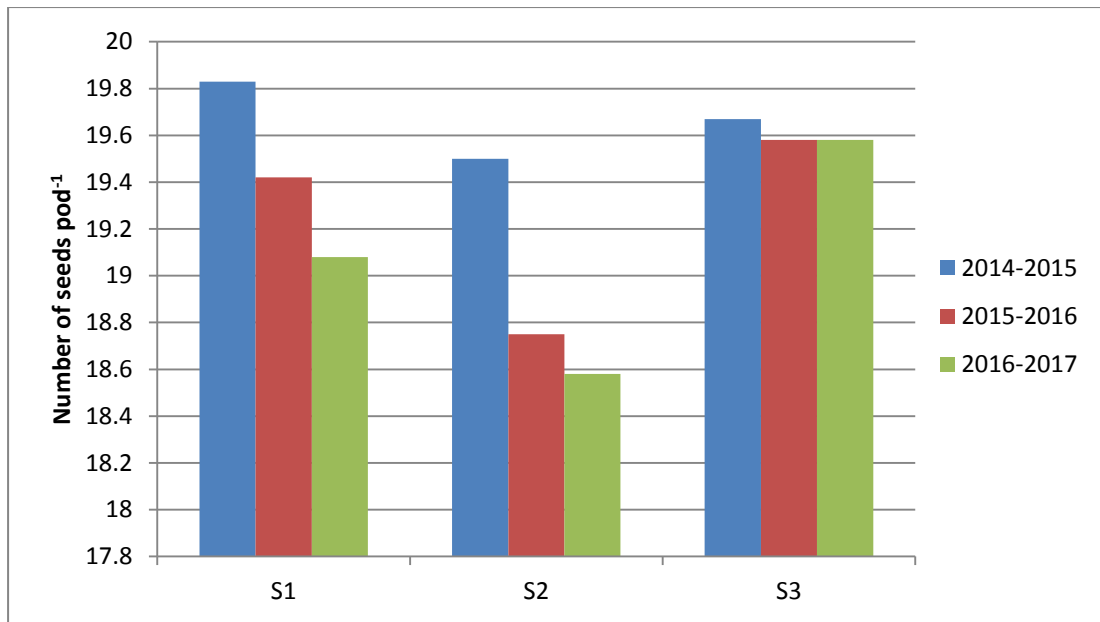

Figure 43. Effect of sowing time on number of seeds pod⁻¹ of mustard in the growing seasons of 2014-2015, 2015-2016 and 2016-2017 in farmer's field.

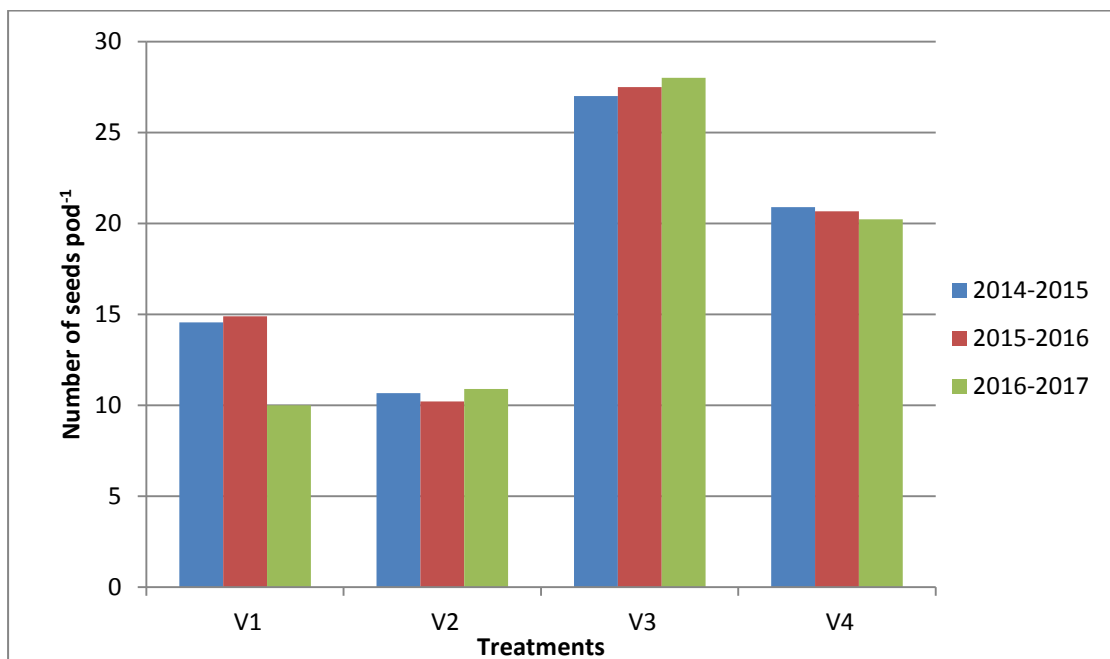

Figure 44. Effect of variety on number of seeds pod⁻¹ of mustard in the growing seasons of 2014-2015, 2015-2016 and 2016-2017 in farmer's field.

4.3.9 Number of seeds plant⁻¹

The combined effect of sowing time and variety on number of seeds plant⁻¹ of mustard in three different growing seasons was found significant. Table 26 indicated that treatment S₂V₃ produced the highest number of seeds plant⁻¹ (2000.00, 1990.00 and 2046.00) whereas treatment S₃V₂ gave the lowest number of seeds plant⁻¹ (1000.00, 950.50 and 990.00) which were statistically different from all other treatments in both the growing seasons of 2014-15, 2015-16 and 2016-17.

Figure 45 indicated that among three different sowing times, treatment S₂ gave the maximum and treatment S₃ produced the minimum number of seeds plant⁻¹ in all three growing seasons which were significantly different from all other treatments.

Number of seeds plant⁻¹ significantly changed by variety. Treatment V₃ produced the highest number of seeds plant⁻¹ and treatment V₁ gave the lowest number of seeds plant⁻¹ which were also statistically different from all other treatments in all three growing seasons (Figure 46).

This results are more or less similar with the result of Takar and Jat (2005) which they observed the effect of sowing date on aphid incidence was least on early sown (10 October 2000) crops compared to late sown crops (30 October 2000). The highest yield was obtained in crops sown on 10 October and the crops sown after this date recorded drastic reductions in yield.

Results are in similar with the result of Rahman (2002) who stated that yield variation existed among varieties and the highest seed yield was observed in BARI Sarisha 7, BARI Sarisha 8 and BARI Sarisha 11 (2.00-2.50 t ha⁻¹) and the lowest yield in variety Tori 7 (0.95-1.10 t ha⁻¹). BARI (2001) showed that seed yield and other yield contributing characters significantly varied among the varieties.

Table 26. Combined effect of sowing time and variety on number of seeds plant⁻¹ of mustard in three growing seasons at farmer's field.

Treatments		Number of seeds plant ⁻¹		
Sowing time	Variety	2014-2015	2015-2016	2016-2017
S ₁	V ₁	1185.00 g	1150.00 f	1180.00 I
	V ₂	1350.00 e	1310.00 d	1346.00 g
	V ₃	1950.00 b	1985.00 a	2016.00 b
	V ₄	1350.00 e	1330.00 d	1357.00 f
S ₂	V ₁	1175.00 g	1110.00 f	1132.00 k
	V ₂	1300.00 f	1225.00 e	1277.00 h
	V ₃	2000.00 a	1990.00 a	2046.00 a
	V ₄	1490.00 c	1445.00 c	1491.00 d
S ₃	V ₁	1190.00 g	1150.00 f	1170.00 j
	V ₂	1000.00 h	990.500 g	990.00 l
	V ₃	2000.00 a	1900.00 b	2011.00 c
	V ₄	1400.00 d	1350.00 d	1389.00 e
LS		*	*	*
CV (%)		56.92	11.15	10.84
LSD (5%)		24.90	48.84	4.03

Means followed by the same letter (s) do not statistically differ at 5% level tested by DMRT. Here, *and ** indicate significant effect at 5% and 1% level of probability respectively. NS = Non-significant.

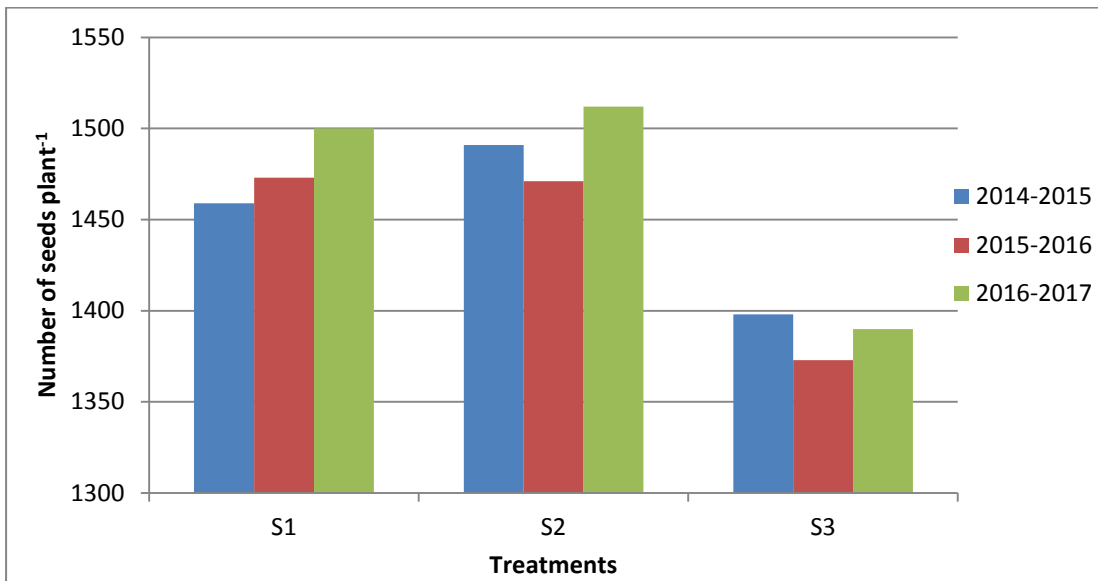

Figure 45. Effect of sowing time on number of seeds plant⁻¹ of mustard in the growing seasons of 2014-2015, 2015-2016 and 2016-2017 in farmer's field.

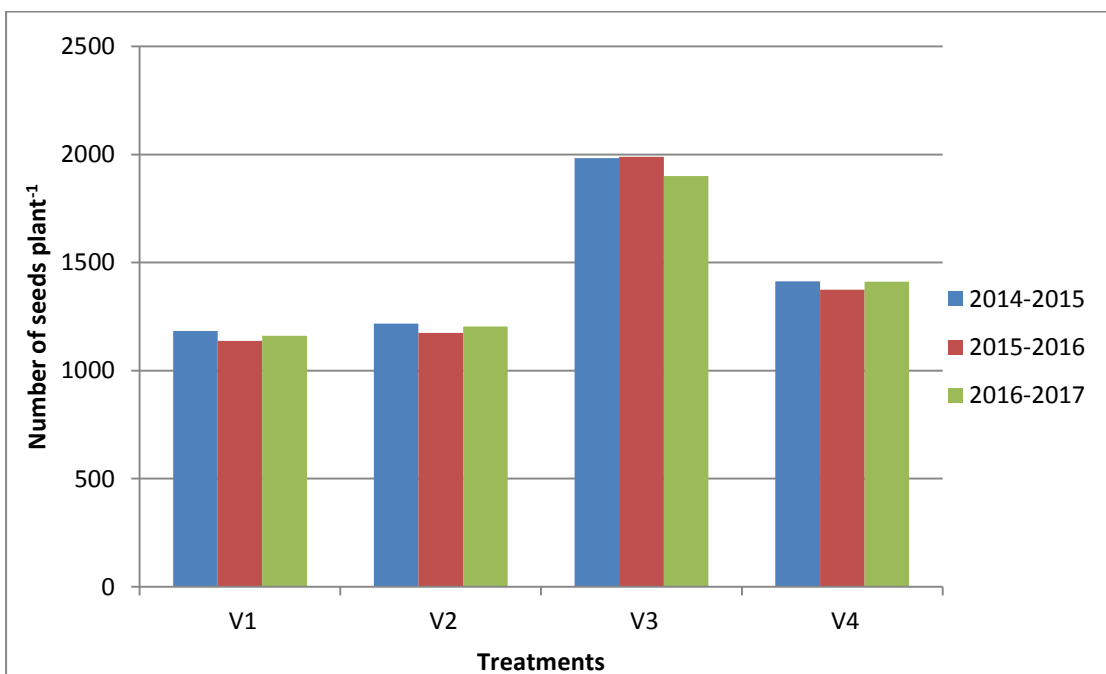

Figure 46. Effect of variety on number of seeds plant⁻¹ of mustard in the growing seasons of 2014-2015, 2015-2016 and 2016-2017 in farmer's field.

4.3.10 1000-seeds weight (g)

1000-seeds weight of mustard significantly changed by the combined effect of sowing time and variety. The obtained results are presented in Table 27 and Figures 47-48. In all three growing seasons the maximum 1000- seeds weight (2.90, 2.93 and 2.90 g) were observed in treatment S_2V_2 whereas the lowest 1000-seeds weight (2.33, 2.27 and 2.27 g) were found in treatment S_3V_1 in all three growing seasons (Table 27).

In all three growing seasons the 1000- seeds weight found statistically non-significant due to the effect of sowing time (Figure 47).

Figure 48 shows that in four different varieties, treatment V_2 produced the maximum 1000 -seeds weight whereas treatment V_1 gave the lowest 1000- seeds weight which were significantly different from all other treatments in the growing seasons of 2014-15, 2015-16 and 2016-17.

Results are in similar with the results of Mondal and Wahab (2001) which they observed that 1000-seeds weight was 2.5-2.65g in improved Tori 7 (*B. campestris*) and 1.5-7.8g in Rai-5 (*B. juncea*).

These results are also similar with the results of BARI (2001) which they achieved that there was significant variation in 1000-seeds weight of mustard observed in different varieties and highest weight of 1000-seeds was found in jamalpur-1 variety and lowest in BARI Sarisha-10.

This findings are similar with the findings of Hussain *et al.* (1998) which they observed that significant variation in case of 1000-seeds weight as influenced by different varieties. They found Hyda-401 had the highest 1000-seeds weight (3.4g) and the lowest 1000-seeds weight was recorded in Tori 7 (2.1g).

Table 27. Combined effect of sowing time and variety on 1000 - seeds weight (g) of mustard in three growing seasons at farmer's field.

Treatments		1000 -seeds weight (g)		
Sowing time	Variety	2014-2015	2015-2016	2016-2017
S ₁	V ₁	2.39 bc	2.50 ab	2.50 bc
	V ₂	2.67 abc	2.57 ab	2.57 b
	V ₃	2.63 abc	2.63 ab	2.90 a
	V ₄	2.50 abc	2.50 ab	2.50 bc
S ₂	V ₁	2.52 abc	2.33 b	2.33 cd
	V ₂	2.90 a	2.93 a	2.90 a
	V ₃	2.87 ab	2.63 ab	2.67 b
	V ₄	2.43 abc	2.43 ab	2.47 bcd
S ₃	V ₁	2.33 c	2.27 b	2.27 d
	V ₂	2.58 abc	2.50 ab	2.47 bcd
	V ₃	2.90 a	2.87 a	2.63 b
	V ₄	2.60 abc	2.60 ab	2.53 bc
LS		*	*	*
CV (%)		9.54	10.12	5.17
LSD (5%)		0.42	0.44	0.22

Means followed by the same letter (s) do not statistically differ at 5% level tested by DMRT. Here, *and ** indicate significant effect at 5% and 1% level of probability respectively. NS = Non-significant.

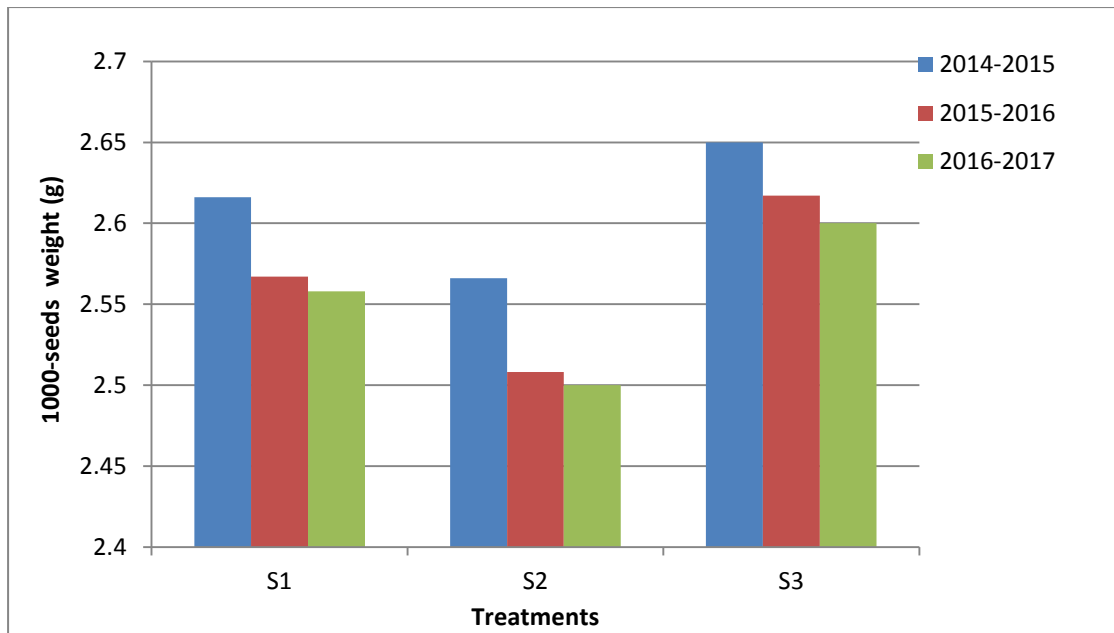

Figure 47. Effect of sowing time on 1000- seeds weight (g) of mustard in the growing seasons of 2014-2015, 2015-2016 and 2016-2017 in farmer's field.

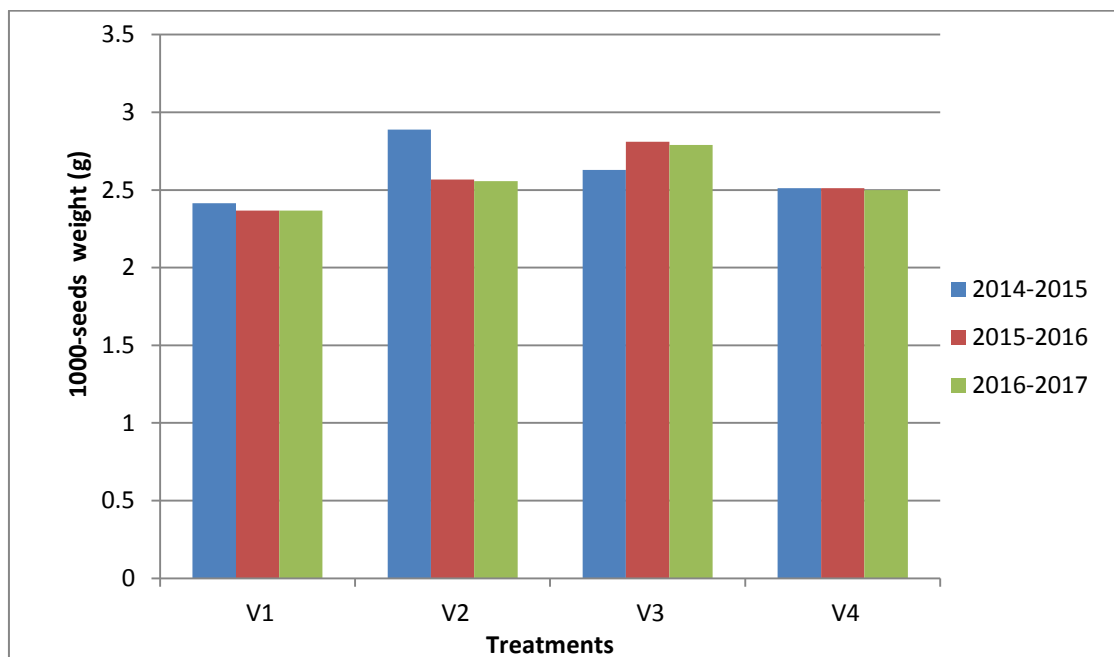

Figure 48. Effect of variety on 1000 -seeds weight (g) of mustard in the growing seasons of 2014-2015, 2015-2016 and 2016-2017 in farmer's field.

4.3.11 Seed yield (kg ha⁻¹)

Seed yield significantly influenced by the combined effect of sowing time and variety. The obtained results are presented in Table 28 and Figures 49-50. The maximum seed yield (1800.00 kg ha⁻¹) of mustard was found in treatment S₂V₂ which was significantly different from all other treatments except S₁V₂ whereas the minimum seed yield (980.00 kg ha⁻¹) was found in treatment S₃V₁ which was statistically identical with S₁V₁, S₁V₄ and S₂V₁ in the growing season of 2014-15 (Table 28).

In the growing seasons of 2015-16 and 2016-17, treatment S₂V₂ produced the maximum seed yield (1800.00 and 1815.00 kg ha⁻¹) which was significantly difference from all other treatments. Treatment S₃V₁ gave the minimum (880.80 and 880.00 kg ha⁻¹) seed yield which were also statistically different from all other treatments except S₁V₁.

Seed yield of mustard was found to significantly influence by sowing time. Treatment S₂ produced the highest seed yield whereas treatment S₃ gave the lowest in all three growing seasons (Figure 49).

Figure 50 indicated that variety have significance changed on seed yield. The maximum seed yield was found in treatment V₂ and the minimum was in V₁ which were statistically different from all other treatments in the growing seasons of 2014-15, 2015-16 and 2016-17.

These results are in agreement with the results of Kumar and Sharma (2006) which they found that delay in sowing beyond 5 November significantly decreased the yields of Indian mustard. This result is also similar with the result of (Kondra, 1977; Degenhardt and Kondra, 1981) which they observed decreased seed yield of *B. napus* and *B. campestris* with delayed sowing.

Table 28. Combined effect of sowing time and variety on seed yield (kg ha⁻¹) of mustard in three growing seasons at farmer's field.

Treatments		Seed yield (kg ha ⁻¹)		
Sowing time	Variety	2014-2015	2015-2016	2016-2017
S ₁	V ₁	1000.00 fg	901.00 h	900.30 i
	V ₂	1730.00 a	1700.00 b	1710.00 b
	V ₃	1100.00def	1000.00 f	1020.00 g
	V ₄	1050.00efg	1120.00 de	1150.00 d
S ₂	V ₁	1010.00 fg	950.00 g	950.00 h
	V ₂	1800.00 a	1800.00 a	1815.00 a
	V ₃	1120.00 de	1020.00 f	1075.00 f
	V ₄	1245.00 c	1150.00 d	1195.00 d
S ₃	V ₁	980.00 g	880.80 h	880.00 I
	V ₂	1520.00 b	1600.00 c	1620.00 c
	V ₃	1120.00 de	1000.00 f	1070.00 f
	V ₄	1190.00 cd	1100.00 e	1120.00 e
LS		*	*	*
CV (%)		4.23	16.22	3.04
LSD (5%)		99.13	38.77	42.17

Means followed by the same letter (s) do not statistically differ at 5% level tested by DMRT. Here, *and ** indicate significant effect at 5% and 1% level of probability respectively. NS = Non-significant.

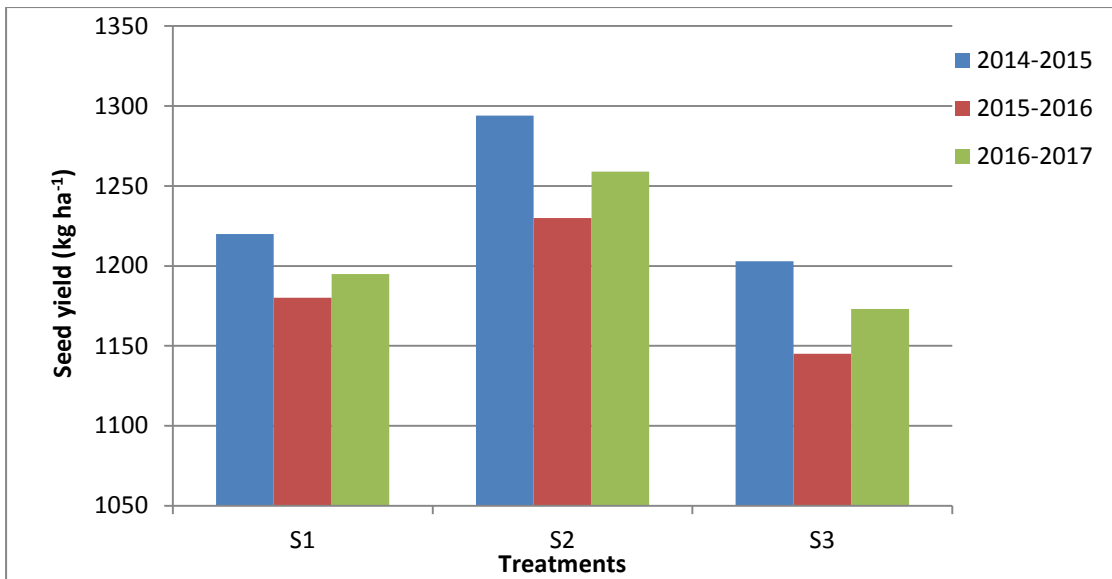

Figure 49. Effect of sowing time on seed yield (kg ha⁻¹) of mustard in the growing seasons of 2014-2015, 2015-2016 and 2016-2017 in farmer's field.

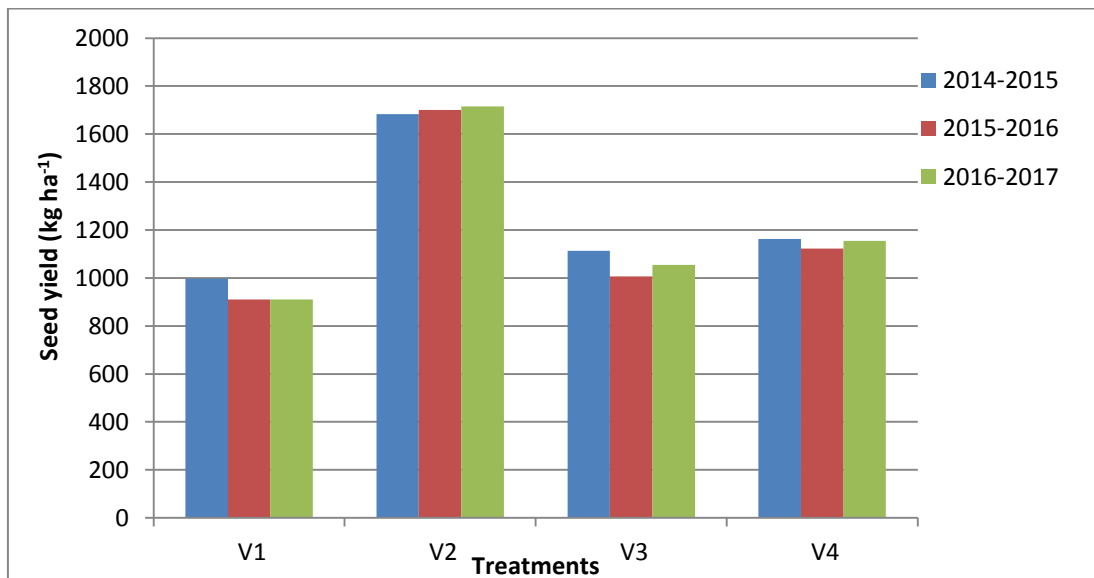

Figure 50. Effect of variety on seed yield (kg ha⁻¹) of mustard in the growing seasons of 2014-2015, 2015-2016 and 2016-2017 in farmer's field.

4.3.12 Straw yield (kg ha⁻¹)

The combined effect of sowing time and variety significantly changed the straw yield of mustard and it is presented in Table 29 and Figures 51-52. Table 29 showed that in the growing season of 2014-15 treatment S₁V₂ originated the highest straw yield (2300.00 kg ha⁻¹) which was statistically similar with S₂V₂ and S₂V₃. Treatment S₃V₄ gave the lowest (1800.00 kg ha⁻¹) seed yield which was statistically similar with S₁V₄. In the growing seasons of 2015-16 and 2016-17 the maximum straw yield (2300.00 and 2399.00 kg ha⁻¹) were observed in treatment S₂V₂ which was significantly different from all other treatments whereas the lowest straw yield (1700.00 and 1780.00 kg ha⁻¹) were found in treatment S₁V₄ and S₃V₄ which were statistically similar with S₃V₄ and S₁V₄.

The effect of sowing time on straw yield (kg ha⁻¹) was statistically significant. The results have been presented in Figure 51. The highest straw yield was produced in the treatment S₂ in the growing season 2014-2015 and the lowest was produced in S₃ in the growing season 2014-2015 at farmer's field. In case of growing season 2015-2016 the maximum straw yield was observed in S₂ and the minimum was in S₁. Any other way the highest straw yield was observed in growing season 2016-2017 in the treatment S₂ and lowest was in S₃ which were statistically different from all other treatments.

The effect of variety on straw yield kg ha⁻¹ was found in very much significant. The results have been presented in Figure 52. Among four different varieties, V₂ (BARI Sharisha 11) produced maximum straw yield in all the three growing seasons. The minimum straw yield was found in treatment V₄ in the growing season 2014-2015, 2015-2016 and 2016-2017 which were significantly different from all other treatments.

Results are in agreement with the results of Hossain *et al.* (2013) found significant influence on straw yield due to sowing method. The line sowing method produced the highest straw yield (2.85 t ha⁻¹). The lowest straw yield (2.66 t ha⁻¹) was found in broadcasting method.

Hossain *et al.* (2012) noted that BARI Sarisha 8 (*Brassica napus*) had the highest response to B application. Any other way BARI Sarisha 11 (*Brassica juncea*) showed the minimum response. The mean yields of *B. campestris* varieties were 2224-2702kg ha⁻¹, *B. napus* varieties were 2850-3199 kg ha⁻¹, and yields of *B. juncea* varieties were 3080-3528 kg ha⁻¹ for the B control plots.

Table 29. Combined effect of sowing time and variety on straw yield (kg ha⁻¹) of mustard in three growing seasons at farmer's field.

Treatments		Straw yield (kg ha ⁻¹)		
Sowing time	Variety	2014-2015	2015-2016	2016-2017
S ₁	V ₁	2100.00 c-e	1900.00 fg	2000.00 f
	V ₂	2300.00 a	2200.00 b	2298.00 b
	V ₃	2150.00 b-d	2000.00 e	2099.00e
	V ₄	1850.00 g	1700.00 h	1800.00i
S ₂	V ₁	2000.00 ef	2100.00cd	2150.00 d
	V ₂	2250.00 ab	2300.00a	2399.00 a
	V ₃	2210.00 a-c	2050.00 de	2100.00e
	V ₄	2080.00 de	1850.00 g	1900.00h
S ₃	V ₁	1900.00 fg	1910.00 f	1951.00 g
	V ₂	2015.00 e	2100.00 cd	2170.00 d
	V ₃	2170.00 b-d	2120.00 c	2200.00 c
	V ₄	1800.00 g	1705.00h	1780.00 i
LS		*	*	*
CV (%)		6.25	3.24	1.35
LSD (5%)		105.7	53.07	23.81

Means followed by the same letter (s) do not statistically differ at 5% level tested by DMRT Here, *and ** indicate significant effect at 5% and 1% level of probability respectively. NS = Non-significant.

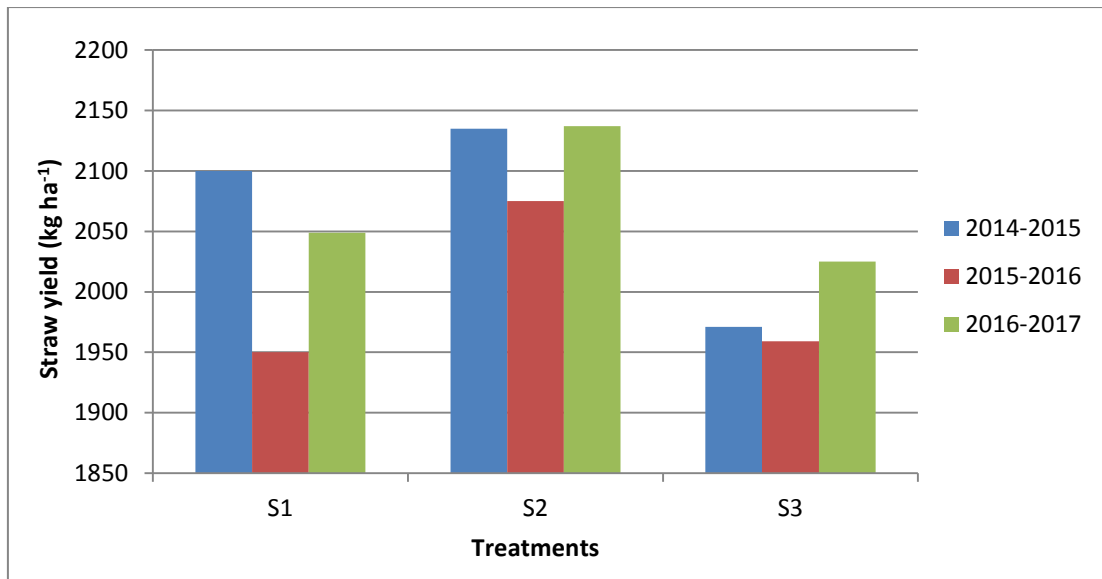

Figure 51. Effect of sowing time on straw yield (kg ha⁻¹) of mustard in the growing seasons of 2014-2015, 2015-2016 and 2016-2017 in farmer's field.

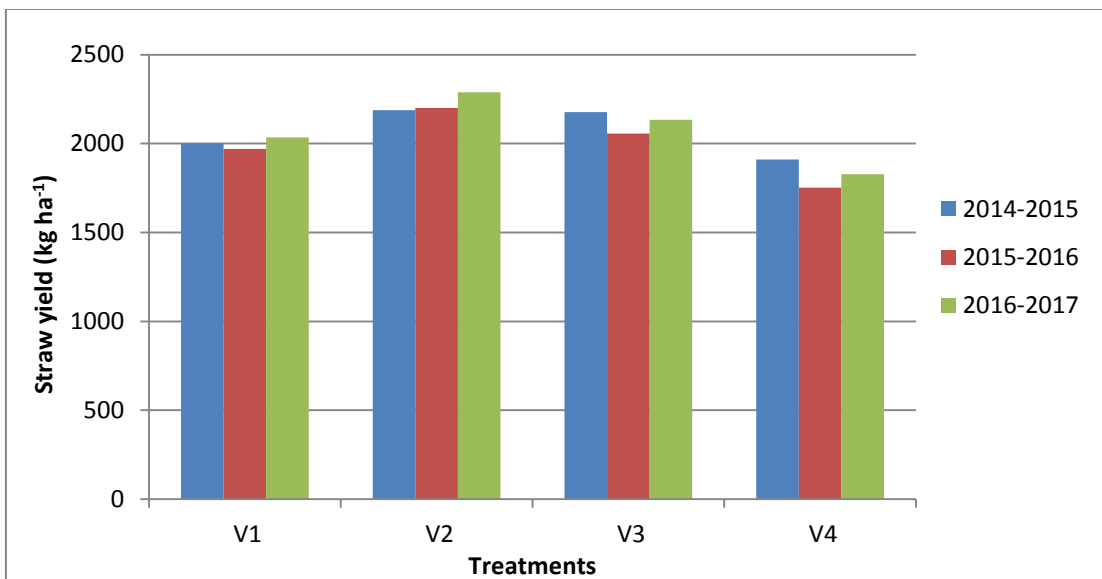

Figure 52. Effect of variety on straw yield (kg ha⁻¹) of mustard in the growing seasons of 2014-2015, 2015-2016 and 2016-2017 in farmer's field.

4.3.13 Oil yield (kg ha⁻¹)

The oil yield of mustard was influenced significantly by the combined effect of sowing time and variety. Table 30 indicated that in the growing season of 2014-15 oil yield was statistically non-significant. Treatment S₃V₂ produced the highest oil yield (315.00 kg ha⁻¹) followed by S₂V₃ and S₃V₁ whereas the lowest oil yield was found (280.0 kg ha⁻¹) in treatments S₁V₃ and S₂V₄ which were statistically identical with all other treatments except S₂V₃, S₃V₁ and S₃V₂ in the growing season of 2015-16.

In the growing season of 2016-17, treatment S₃V₂ produced the maximum oil yield (340.20 kg ha⁻¹) which was statistically identical with S₃V₁. Treatment S₂V₄ gave the lowest oil yield (285.00 kg ha⁻¹) which was statistically identical with treatment S₁V₃, S₁V₄ and S₃V₄ (Table 30).

The effect of sowing time on oil yield (kg ha⁻¹) was statistically significant. The results have been presented in Figure 53. Oil yield found statistically non-significant in the growing season of 2014-2015. Treatment S₃ produced the maximum oil yield in growing season 2015-16 and the lowest was treatment S₁. In case of the growing season of 2016-17 treatment S₃ also produced maximum oil yield and the minimum was in treatment S₁ which were statistically different from all other treatments.

Figure 54 shows that in the growing seasons of 2014-15 and 21015-16 oil yield was statistically non-significant. Treatment V₂ produced the maximum oil yield whereas V₄ gave the minimum which was statistically different from all other treatments in the growing season of 2016-17.

These results are in acquiescence with the findings of Bishnoi and Kanwar Singh (1979) which they conducted experiment at Haryana Agricultural University, Hissar and stated that oil yield recorded higher in 10th October sowing (880 kg ha⁻¹) as compared to 20th November sowing (380 kg ha⁻¹). This finding also supports the findings of Kurmi

and Kalita (1992) Which they reported that oil yield recorded higher with 17th November sowing (388.17 kg ha⁻¹) as compared to 2nd December sowing (818 kg ha⁻¹) in Jorhat (Assam). This result are in agreement with the result of Das (1998) who reported that sowing mustard on 27th October recorded higher oil yield as compared to 27th November.

Table 30. Combined effect of sowing time and variety on oil yield (kg ha⁻¹) of mustard in three growing seasons at farmer's field.

Treatments		Oil yield (kg ha ⁻¹)		
Sowing time	Variety	2014-2015	2015-2016	2016-2017
S ₁	V ₁	280.00	300.00 ab	305.20 cd
	V ₂	275.00	290.00 ab	310.00 cd
	V ₃	300.00	280.00 b	295.00 de
	V ₄	290.00	300.00 ab	302.00 c-e
S ₂	V ₁	299.00	290.00 ab	320.10 bc
	V ₂	305.00	300.00 ab	310.90 cd
	V ₃	285.00	310.00 a	320.40 bc
	V ₄	300.00	280.00 b	285.00 e
S ₃	V ₁	310.00	310.00 a	330.00 ab
	V ₂	302.00	315.00 a	340.00 a
	V ₃	315.00	305.00 ab	318.00 bc
	V ₄	301.00	290.00 ab	298.00 de
LS		NS	*	*
CV (%)				
LSD (5%)		73.27	21.96	16.32

Means followed by the same letter (s) do not statistically differ at 5% level tested by DMRT. Here, *and ** indicate significant effect at 5% and 1% level of probability respectively. NS = Non-significant.

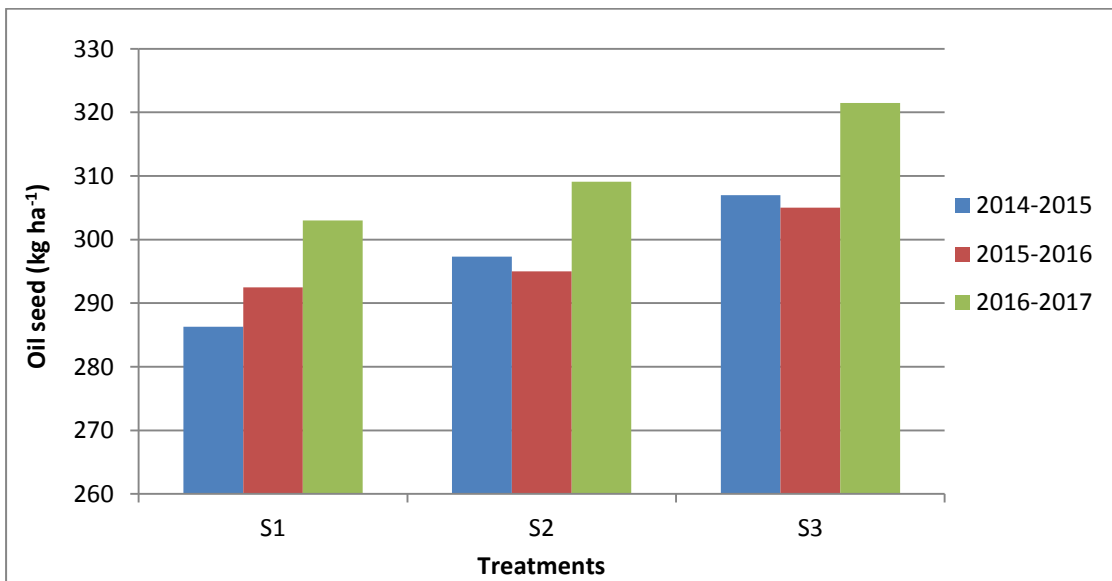

Figure 53. Effect of sowing time on oil yield (kg ha⁻¹) of mustard in the growing seasons of 2014-2015, 2015-2016 and 2016-2017 in farmer's field.

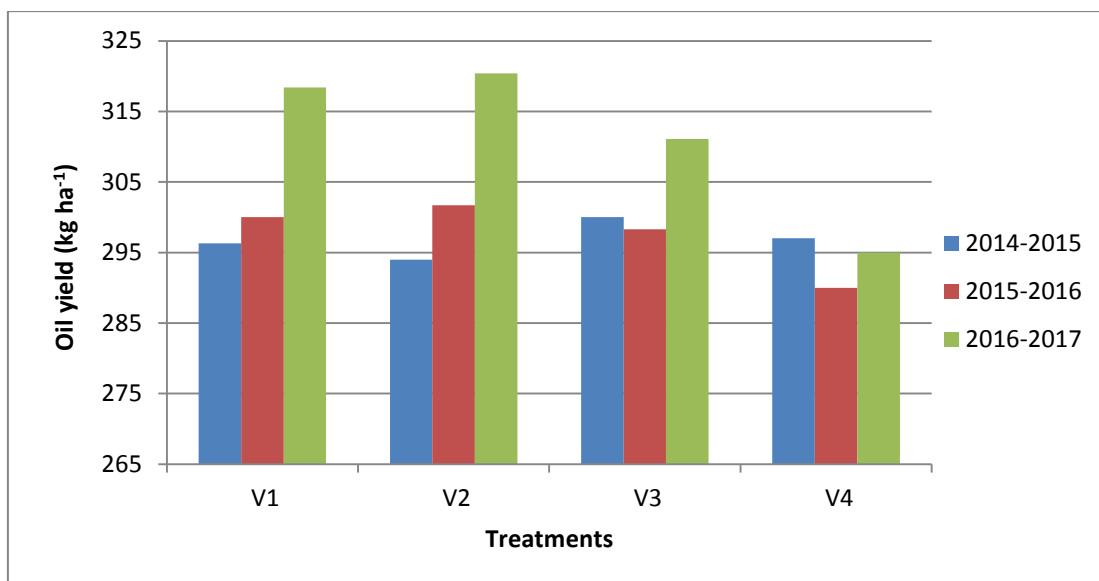

Figure 54. Effect of variety on oil yield (kg ha⁻¹) of mustard in the growing seasons of 2014-2015, 2015-2016 and 2016-2017 in farmer's field.

4.4 Yield gap analysis and strategies for minimizing the gaps of mustard

In this case the yield gap of mustard found between research field and farmer's field in the growing seasons of 2014-15, 2015-16 and 2016-17 was analyzed and find out the causes of yield gap and make strategies for minimizing the gaps.

4.4.1 Yield gap analysis

Yield gaps exist in different crops of Bangladesh. Yield gaps in crops are real and the challenge needs to be addressed in the interest of increased and sustainable crop production. To evaluate the yield gap in mustard, study was carried out in the research field of Regional Agricultural Research Station, Khainrila, Jessore and in the farmer's field of Karimpur village, Jessore during the period from October, 2014 to March 2015; October 2015 to March 2016 and October 2016 to March 2017 to investigate the effects of sowing time, variety on the field contributing characters and yield of mustard. The results are shown in Table 31-33. Under the growing season of 2014-2015 the yield gaps among different treatments were 280.00, 80.00, 350.00, 520.00, 290.00, 395.00, 698.00, 353.00, 290.00, 380.00, 305.00 and 310.00 kg ha⁻¹ respectively and in the % were 21.87, 4.42, 24.14, 33.12, 22.31, 17.99, 38.39, 22.09, 22.83, 20.00, 21.40 and 20.67 respectively (Table 31). In the growing season of 2015-2016 the yield gaps were 400.00, 400.00, 425.00, 410.00, 360.00, 480.00, 470.00, 435.00, 329.20, 510.00, 430.00 and 436.00 kg ha⁻¹ and in the % were 30.74, 19.06, 29.82, 26.79, 27.48, 21.05, 31.54, 27.44, 27.21, 24.17, 30.07 and 28.38 respectively (Table 32). From the growing season of 2016-2017 the yield gaps were 419.70, 447.00, 470.00, 430.00, 426.00, 471.00, 440.00, 594.00, 400.00, 520.00, 405.00 and 429.00 kg ha⁻¹ and in % were 31.79, 20.72, 31.54, 27.21, 30.96, 20.60, 29.04, 37.10, 31.25, 24.76, 27.45, 27.60 and 95.00 respectively (Table 33).

Table 31. Yield gap and yield gap percentage of mustard between research and farmer's field in the growing season of 2014-2015.

Sowing time	Variety	Yield (kg ha ⁻¹)			Yield gap (%)
		Research field	Farmer's field	Yield gap	
S ₁	V ₁	1280.00	1000.00	280.00	21.87
	V ₂	1810.00	1730.00	80.00	4.42
	V ₃	1450.00	1100.00	350.00	24.14
	V ₄	1570.00	1050.00	520.00	33.12
S ₂	V ₁	1300.00	1010.00	290.00	22.31
	V ₂	2195.00	1800.00	395.00	17.99
	V ₃	1818.00	1120.00	698.00	38.39
	V ₄	1598.00	1245.00	353.00	22.09
S ₃	V ₁	1270.00	980.00	290.00	22.83
	V ₂	1900.00	1520.00	380.00	20.00
	V ₃	1425.00	1120.00	305.00	21.40
	V ₄	1500.00	1190.00	310.00	20.67

The highest yield of mustard 2195.00 kg ha⁻¹ was observed in research field and 1800.00 kg ha⁻¹ was in farmer's field with a yield gap of 39.00 kg ha⁻¹ and 17.99 % from the treatment S₂V₂ (10th November sowing time with variety BARI Sarisha 11) in the growing season of 2014-15 (Table 31).

Table 32. Yield gap and yield gap percentage of mustard between research and farmer's field in the growing season of 2015-2016.

Sowing time	Variety	Yield (kg ha ⁻¹)			Yield gap (%)
		Research field	Farmer's field	Yield gap	
S ₁	V ₁	1301.00	901.00	400.00	30.74
	V ₂	2100.00	1700.00	400.00	19.04
	V ₃	1425.00	1000.00	425.00	29.82
	V ₄	1530.00	1120.00	410.00	26.79
S ₂	V ₁	1310.00	950.00	360.00	27.48
	V ₂	2280.00	1800.00	480.00	21.05
	V ₃	1490.00	1020.00	470.00	31.54
	V ₄	1585.00	1150.00	435.00	27.44
S ₃	V ₁	1210.00	880.80	329.20	27.20
	V ₂	2110.00	1600.00	510.00	24.17
	V ₃	1430.00	1000.00	430.00	30.06
	V ₄	1536.00	1100.00	436.00	28.38

Table 32 shows that In the growing season of 2015-16, the maximum yield of mustard 2280.00 kg ha⁻¹ was found in research field and 1800.00 kg ha⁻¹ was in farmer's field with a yield gap of 480.00 kg ha⁻¹ and 21.05% from the treatment S₂V₂ (10th November sowing time with variety BARI Sarisha 11).

Table 33. Yield gap and yield gap percentage of mustard between research and farmer's field in the growing season of 2016-2017.

Sowing time	Variety	Yield (kg ha ⁻¹)			Yield gap (%)
		Research field	Farmer's field	Yield gap	
S ₁	V ₁	1320.00	900.30	419.70	31.79
	V ₂	2157.00	1710.00	447.00	20.72
	V ₃	1490.00	1020.00	470.00	31.54
	V ₄	1580.00	1150.00	430.00	27.21
S ₂	V ₁	1376.00	950.00	426.00	30.95
	V ₂	2286.00	1815.00	471.00	20.60
	V ₃	1515.00	1075.00	440.00	29.04
	V ₄	1601.00	1195.00	594.00	37.10
S ₃	V ₁	1280.00	880.00	400.00	31.25
	V ₂	2100.00	1620.00	520.00	24.76
	V ₃	1475.00	1070.00	405.00	27.45
	V ₄	1549.00	1120.00	429.00	27.69

Table 33 indicated that the treatment S₂V₂ also produced the highest yield of mustard 2286.00 kg ha⁻¹ in research field and 1815.00 kg ha⁻¹ was in farmer's field with a yield gap of 471.00 kg ha⁻¹ and 20.60% in the growing season of 2016-17.

These results are in similar with the results of Meena *et al.* (2012) which described the yield gap analysis of rapeseed-mustard through front line demonstrations in agro climatic zone IV of Rajasthan. The recommended revealed that a gap exists between the actual farmer's yield and realizable yield potential of the variety. Use of improved variety carry potential to enhance the present level of mustard productivity which is not percolating down at desired pace due to lack of confidence among the farmers. This gap calls for a on farm assessment of the production technology developed for the individual oilseed crops besides ensuring the requirements of production inputs related packages and knowledge to minimize yield gap I and yield gap II. This result is similar with the result

of Singh *et al.* (2007) where they described two types of yield gap in terms of technological and extension yield gaps using frontline demonstrations data (FLD) on mustard. They observed that there was positive impact of FLD over existing practices for farming community of Luck now districts and they were motivated by the new agricultural technologies applied in the field plots. Results showed that use of developed variety (Pusajaisan), line sowing, balanced application of fertilizers and control of mustard aphid through insecticide at economic threshold level, produced on an average 45.97 percent more yield of mustard as compared to local check (12.4q/ha).

4.4.2 Factors causing yield gaps in mustard

Several factors can cause yield gaps in mustards. A comparison between demonstration (research) package and actual farmers practice under mustard cultivation is presented in Table 34. In general, factors causing yield gaps can be classified as follows (RAP, 1999).

Biological factors

Biological factors play an important role for yield gap during mustard cultivation. For cultivated variety, soil fertility, management practices (fertilizer, water, pest management, etc.)

Socio-economic factors

Social and economic status of farmers, family size, farm holding, knowledge and education level of farmers, contact with extension agents.

Climatic factors

Flood, drought, salinity, etc. caused by climatic changes.

Institutional / government policy related factors

Input/ output price, availability of inputs, credit supply, tenancy, etc. The price of produces and fertilizers could influence the rate of fertilizer use by farmers and there by yield.

Factors promoting technology transfer

Research extension linkage, training of extension personnel on the new technology, their knowledge and education level about the technology, demonstration of the technology, field visits and monitoring, etc. by extension.

Table 34. Comparison between demonstration package and existing farmers practice under mustard cultivation.

Particulars	Mustard demonstration package	Farmers practice
Farming situation	Well drained medium high land	Irrigated medium high land
Variety	BARI Sarisha 9 BARI Sarisha 11 BARI Sarisha 14 BARI Sarisha 15	Do
Time of sowing	30 th October 10 th November 20 th November	Do
Seed rate	2.5 kg ha ⁻¹	4.5 kg ha ⁻¹
Method of sowing	Line sowing	Broad Casting
Fertilization dose	Cow dung 10 ton/ha and NPKSB 100-90-50-35-1.5 kg ha ⁻¹	Cow dung 10 ton/ha and NPK as 54-60-15 kg ha ⁻¹
Plant protection	Need based malathion-57 EC@ 2ml/liter of water to protect the crop against mustard aphids	Nil
Weed management	Weeding was done with nirani and hand weeding was done	Nil

4.4.3 Strategies for minimizing of yield gaps

Promotion of integrated crop management

Yield gaps caused by biological, socio-economic and institutional constraints can be effectively addressed through an integrated crop management (ICM) practices. Transfer of the practices through extension agents could effectively help farmers minimize yield gaps. Timely planting, Irrigation, weeding, plant protection and timely harvesting could account for more than 20% yield increase (Siddiq, 2000). However, input/ output prices and employment opportunities influence farmer's decision on the level of inputs to be applied (Table 34).

Adequate input and credit supplies

Inputs play an important role in the productivity of crops and minimizing yield gaps. Farmers need adequate amounts of quality inputs at the right time to obtain high yields. It is also important that the fertilizer inputs are integrated with organic manures for balanced use of nutrients. Resource-poor small but productive farmers representing more than 80% of farm population are usually unable to purchase required quantities of the inputs for application for better yield. Therefore, these farmers need to be supported by adequate and timely supply of credit to narrow yield gaps. But the current credit system in Bangladesh remains far below the needs of small farmers. They have very limited access to institutional credit mainly because of collateral requirement. Therefore, appropriate measures must be taken to reduce transaction costs, simplify lending procedures, revise eligibility criteria and strengthen monitoring and supervision mechanism of the credit system. The action may also be taken for the expansion of rural bank branches under public sectors.

Research and extension support

The support of research and extension is necessary for narrowing yield gap. The researcher should understand farmer's constraints to high productivity and accordingly develop integrated technological package (appropriate variety, timely planting, fertilizer, irrigation and pest management) for farmers for specific locations to bridge up the gaps. The extension service should at the same time ensure that the farmers apply correctly and systematically the recommended technological packages in fields through effective training, demonstrations, field visits, monitoring etc. The judicious application of inputs from seeding to heading in terms of quantity and timing will significantly contribute to reducing yield gaps and thereby increasing productivity of crops.

Policy support

As mentioned earlier, socio-economic and institutional/policy constraints can cause yield gap significantly. It is thus necessary that the government address the issues seriously and come forward with solutions to the problems to increase productivity by minimizing the yield gaps. Hanson *et al.* (1982) recommended that the government find solutions to socio-economic and political questions for narrowing the agronomic gap between farmer's fields and the research station.

CHAPTER FIVE

SUMMARY AND CONCLUSION

In the present investigation, three (03) different experiments were conducted to find out the causes of yield gap and to minimize yield gap of mustard (*Brassica sp.*) through agronomic management techniques. The first experiment was considered with seven (07) varieties of mustard viz. Tori 7, BARI sarisha 9, BARI sarisha 11, BARI sarisha 13, BARI sharisha 14, BARI sarisha 15 and BARI sarisha 16. The first experiment was considered as screening and to find out four (04) most potential mustard varieties for the next two experiments. The second experiment was conducted at research field and the third experiment was conducted at farmer's field. All above experiments was conducted for analyzed the yield gap of mustard found between research field and farmer's field in the growing seasons of 2014-15, 2015-16 and 2016-17 and to find out the causes of yield gap and make strategies for minimizing the gaps.

The first experiment was considered as varietal trial and to find out 04 (four) most potential mustard varieties from 07 (seven) different mustard varieties for the next experiments to minimize yield gap. The experiment of the present study was conducted in the farmer's field of Village - Karimpur, Thana – Bagharpara, Post - Jamdia, District – Jashore during the period from October, 2013 to March, 2014.

Plants height were significantly influenced by variety at 30 and 50 days after sowing (DAS). The tallest plants were found from variety V₃ (83.00 and 110.00 cm) both at 30 and 50 DAS whereas V₁ produced the shortest plants (50.50 and 68.00 cm) both at 30 and 50 DAS. The highest no. of leaves plant⁻¹ in 30 DAS was observed in V₆ (22.50) and the lowest was

observed in V₄ (11.50). In 50 DAS the highest number of leaves plant⁻¹ was found in V₂ (27.80) and the lowest was observed in V₄ (18.20). Number of branches plant⁻¹ was found non-significant both in 30 and 50 DAS. The maximum number of pods plant⁻¹, number of effective pods plant⁻¹ and number of non-effective pods plant⁻¹ (110.00, 102.00 and 8.00) were found in variety V₃ and the minimum were found in V₁ but the minimum non-effective pods plant⁻¹ (4.00) was found in V₂. The highest number of seeds pod⁻¹ and effective seeds pod⁻¹ were found (27.00 and 25.00) in V₄ but maximum number of non-effective seeds pod⁻¹ (6.50) was found in V₂. Variety V₁ produced the minimum number of seeds pod⁻¹ and effective seeds pod⁻¹ (10.00 and 6.00) and V₄ originated the lowest number of non-effective seeds pod⁻¹.

The highest pod length was recorded in V₂ (5.80 cm) and the lowest was in V₁ (4.00 cm). Number of seeds plant⁻¹ was significantly influenced by variety. The maximum seed contained per plant was recorded in V₅ (2372.00) and the minimum was in V₁ (550.00). V₃ originated the maximum 1000-seeds weight (3.80 g) and the minimum was found (2.60 g) in V₁. The maximum days required for flowering and maturity were recorded in V₃ (51.33 and 105.20) and the minimum days required for flowering and maturity were found in V₅ (35.80 and 76.00). The highest seed yield (2320.00 kg ha⁻¹) was observed in V₃ and the lowest (950.00 kg ha⁻¹) was found in V₁. Maximum straw yield (2830.00 kg ha⁻¹) was found in V₃ and the minimum was observed in V₁ (1330.00 kg ha⁻¹). The maximum oil content and oil yield (43.30% and 405.00 kg ha⁻¹) were observed in V₂ and the minimum oil content and oil yield (33.20% and 206.40 kg ha⁻¹) were found in V₁.

The second experiment was conducted at research field during the growing seasons of 2014-2015, 2015-2016 and 2016-2017 with 03 (three)

different sowing times viz. 30th October, 10th November and 20th November and 04 (four) different varieties of mustard viz. BARI sarisha 9, BARI sarisha 11, BARI sarisha 14 and BARI sarisha 15 selected from first experiment and the plant height of mustard induced by different treatments was recorded at 20, 30 and 40 days after sowing and at harvesting time in three different growing seasons. At 20 DAS the maximum plant height (17.33 cm, 16.33 cm and 16.33 cm) were observed in treatments S₁V₂ and S₂V₂ in three different growing seasons and the lowest (11.00 cm, 11.67 cm and 11.67 cm) were found in treatments S₂V₄, S₂V₁ and S₂V₃ in 1st, 2nd and 3rd growing seasons. In 03 (three) different growing seasons at 30 DAS treatments S₁V₂ produced the maximum plant height of 38.67 cm, 37.00 cm and 36.33cm whereas the minimum plant height (26.00 cm, 26.67 cm and 27.33cm) was produced by treatments S₃V₁ and S₂V₁. At 40 DAS the higher plant (75.22 cm) was observed in the treatment S₁V₂ and the lowest (48.44 cm) was observed in S₃V₄. In the growing seasons of 2015-2016 and 2016-2017 the highest plant heights (73.33 cm and 72.67 cm) were observed in treatments S₃V₂ and the lowest (48.00 cm and 47.67 cm) were found in S₃V₄ and S₂V₃. At maturity of mustard, in the growing seasons of 2014-2015, 2015-2016 and 2016-2017 the longest plants (106.0 cm, 106.00 cm and 104.7 cm) were found in treatments S₂V₂, S₁V₂ and S₃V₂ and the shortest plants (70.00 cm, 75.00 cm and 73.33 cm) were observed in S₃V₃ and S₂V₁.

At 20 DAS the maximum number of leaves plant⁻¹ (11.85 , 15.00 and 15.20) were observed in treatments S₁V₃, S₂V₂ and S₂V₃ in three different growing seasons and the lowest (7.78, 10.20 and 10.10) were found in treatments S₃V₄, S₁V₂ and S₁V₄ in 1st, 2nd and 3rd growing seasons . In 03(three) different growing seasons at 30 DAS treatments S₁V₃ and S₂V₂ originated the maximum number of leaves plant⁻¹ of 19.07, 24.10 and

22.07 whereas the minimum leaves plant⁻¹ (12.25, 15.24 and 16.17) were produced by treatments S₃V₃ and S₃V₄. At 40 DAS the highest number of leaves plant⁻¹ (31.25, 33.50 and 33.80) were found in the treatment S₃V₂ and S₂V₂, whereas the lowest leaves plant⁻¹ (22.87, 25.10 and 24.00) was observed in S₁V₄, S₃V₃ and S₃V₄. At maturity of mustard, in the growing season of 2014-2015 the highest number of leaves plant⁻¹ was found (30.00) in S₂V₂ and the lowest was observed in (22.00) S₁V₄. In the growing season of 2015-2016, the maximum leavesplant⁻¹ was (34.03) was produced by treatment S₂V₂ and the lowest (27.25) was in S₃V₃. The highest number of leaves plant⁻¹ was (32.10) was observed in treatment S₂V₂ followed by S₁V₂, S₂V₄ and S₃V₂ and the lowest (25.80) was in S₃V₃ in the growing season of 2015-2016.

The highest number of branches plant⁻¹ (2.33, 2.00 and 1.67) were observed in treatments S₁V₃ in three different growing seasons and the minimum (0.67) was found in treatments S₂V₂, S₂V₄, S₃V₂ and S₁V₄ at 20 DAS. In 03(three) different growing seasons at 30 DAS treatments S₃V₁ produced the maximum number of branches plant⁻¹ of 3.67, 3.00 and 3.00 whereas the minimum number of branches plant⁻¹ (1.33, 1.00 and 1.00) was produced by treatments S₁V₃, S₂V₃, S₂V₄ and S₃V₂. At 40 DAS the highest number of branches plant⁻¹ (7.67, 7.66 and 7.00) were found in the treatment S₁V₁ and S₂V₁, whereas the lowest number of branches plant⁻¹ (2.33) was observed in S₁V₄, S₂V₂, S₂V₃, S₂V₄, S₃V₂ and S₃V₃ in the growing season of 2014-2015, 2015-2016 and 2016-2017. At maturity of mustard, in the growing seasons of 2014-2015, 2015-2016 and 2016-2017 the maximum number of branches plant⁻¹ (13.33, 13.37 and 12.33) were observed in treatment S₁V₁ and the minimum (3.67) were observed in treatments S₁V₄, S₂V₂ and S₂V₃.

Treatment S_2V_2 required maximum days (44.67) for 50% flowering whereas the treatments S_1V_1 , S_2V_1 and S_3V_1 required the minimum days (29.67) in the growing season of 2014-2015. In the growing seasons of 2015-2016 and 2016-2017 treatment S_3V_2 required the maximum days for 50% flowering (42.67) and treatment S_3V_1 required the minimum days (29.00 and 28.67). Treatment S_1V_2 required the maximum days for maturity (106.00) in the growing seasons of 2014-2015 and 2015-2016, both in 2016-2017 treatment S_3V_2 required the maximum days (104.70). The minimum days required (77.33, 75.00 and 77.33) by treatment S_2V_1 in all the growing seasons.

The combined effect of sowing time and variety in relation to pod length was found significant. In the growing season of 2014-2015 pod length was non-significant. The highest length of pod was recorded (5.86 and 5.70 cm) in 10th November sowing time with the variety BARI Sarisha 15 in growing season 2015-2016 and S_2V_1 in 3rd growing season whereas the lowest was recorded (4.00 cm) in S_2V_3 and S_3V_3 in the growing seasons of 2015-2016 and 2016-2017.

The maximum number of pods plant⁻¹ 101.70 in 2014-2015, 118.30 in 2015-2016 and 141.30 in 2016-2017 were observed in treatments S_2V_2 and the lowest number of pods plant⁻¹ 68.25 in 2014-2015, 70.22 in 2015-2016 and 70.17 in 2016-2017 were found in the treatments S_3V_1 .

Number of seeds pod⁻¹ varied significantly due to combined effect of sowing time and variety. Maximum number of seeds pod⁻¹ (26.00, 27.00 and 26.67) were observed in treatments S_1V_3 , and the minimum (12.00, 10.67 and 11.00) were found in treatments S_2V_2 in all three growing seasons.

The combined effect of sowing time and variety showed significant influence in relation to number of seeds plant⁻¹ of mustard in three different growing seasons. In the growing seasons of 2014-2015, 2015-2016 and 2016-2017 highest number of seeds plant⁻¹ (1925.00, 2005.00 and 2010.00) were observed in treatment S₁V₃ whereas the lowest (1300.00 and 1395.00) were found in S₁V₁ in 2014-2015 and 2015-2016 and 1277.00 from S₃V₂ in 2016-17.

In all three growing seasons treatment S₂V₂ produced the highest 1000-seeds weight (3.33g, 3.43g and 3.30g). Any other way treatment S₃V₁ gave the minimum 1000 - seeds weight (2.70g, 2.70g and 2.70g).

The combined effect of sowing time and variety on seed yield of mustard varied significantly. In the growing seasons of 2014-2015, 2015-2016 and 2016-2017, the maximum seed yield (2195.00, 2280.00 and 2286.00 kg ha⁻¹) were found from treatment S₂V₂ and the lowest were (1270.00, 1210.00 and 1280.00 kg ha⁻¹) were observed in treatment S₃V₁ in 2014-2015 but they are significantly different from all other treatments in the growing seasons of 2015-2016 and 2016-2017.

Straw yield of mustard varied significantly with the influence of sowing time, variety and their combination in all three growing seasons. The highest straw yield (2700.00, 2700.00 and 2751.00 kg ha⁻¹) were observed from the treatment S₂V₂ in 2014-2015. The lowest straw yield (2230.00, 2200.00 and 2250.00 kg ha⁻¹) were found in treatment S₃V₄.

Sowing time, variety and their combined effect shows significant variation in relation to oil yield of mustard. The highest amount of oil (400.00 kg ha⁻¹) was obtained in treatment S₂V₂ whereas the lowest (300.00 kg ha⁻¹) was found in treatment S₃V₄ in the growing season of 2014-2015. In 2015-2016, it was found highest (400.00 kg ha⁻¹) in S₁V₁

and lowest (316.70 kg ha⁻¹) in S₁V₂. In the growing season of 2016-2017, the highest oil yield (400.50 kg ha⁻¹) was observed in treatment S₂V₁ and the lowest oil yield (345.80 kg ha⁻¹) was found in treatment S₃V₄.

The third experiment was conducted at farmers field during the growing seasons of 2014-2015, 2015-2016 and 2016-2017 with 03 (three) different sowing times viz. 30th October, 10th November and 20th November and 04 (four) different varieties of mustard viz. BARI sarisha-9, BARI sarisha 11, BARI sarisha 14 and BARI sarisha 15 selected from first experiment. The plant height of mustard induced by different treatments was recorded at 20, 30 and 40 days after sowing and at harvesting time in the growing seasons of 2014-15, 2015-16 and 2016-17. At 20 DAS the maximum plant height (16.50 cm, 16.00 cm and 15.67 cm) were observed in treatments S₁V₂, and S₂V₂ in three different growing seasons and the lowest (10.33 cm, 9.66 cm and 9.66 cm) were found in treatments S₂V₄ and S₃V₁ in 1st, 2nd and 3rd growing seasons. In 03(three) different growing seasons at 30 DAS treatments S₁V₂ produced the maximum plant height of 37.44 cm, 36.33 cm and 36.00cm whereas the minimum plant height (25.00 cm and 24.00 cm) was produced by treatments S₃V₄. At 40 DAS the higher plant (74.00 cm and 73.00 cm) was found in the treatment S₁V₂ and S₂V₂ and the lowest (47.67cm, 46.33 cm and 46.00 cm) was observed in S₃V₃. At maturity of mustard, in the growing seasons of 2014-2015, 2015-2016 and 2016-2017 the longest plants (104.7 cm, 102.7 cm and 103.0 cm) were found in treatments S₂V₂, S₃V₂ and S₁V₂ and the shortest plants (75.33 cm, 74.67 cm and 72.67 cm) were observed in S₁V₁ and S₂V₁.

The number of leaves plant⁻¹ of mustard induced by different treatments was recorded at 20, 30 and 40 days after sowing and at harvesting time in three growing seasons. At 20 DAS the maximum number of leaves plant⁻¹ (11.12, 10.25 and 12.25) were observed in treatment S₂V₃ and the lowest

(7.25, 8.00 and 8.20) were found in treatment S_3V_3 and S_1V_4 (2014-15). At 30 DAS treatments S_1V_3 and S_2V_2 produced the highest number of leaves plant⁻¹ of 21.20, 19.53 and 20.07 whereas the lowest leaves plant⁻¹ (12.25, 12.75 and 14.00) was produced by treatments S_3V_1 , S_3V_3 and S_3V_4 . At 40 DAS the highest number of leaves plant⁻¹ (30.00, 29.00 and 29.28) was observed in the treatment S_2V_2 and S_3V_2 , whereas the lowest number of leaves plant⁻¹ (19.25, 20.00 and 20.11) was observed in S_3V_4 and S_1V_4 in the growing season of 2014-2015, 2015-2016 and 2016-2017. At maturity of mustard, in the growing seasons of 2014-2015, 2015-2016 and 2016-2017 the maximum leaves plant⁻¹ (29.00, 30.00 and 30.01) were found in treatment S_3V_2 and S_2V_2 and the minimum leaves plant⁻¹ (20.00 and 18.00) were observed in treatments S_3V_3 , S_1V_4 and S_3V_4 .

At 20 days after sowing (DAS) the highest number of branches plant⁻¹ (1.67) was observed in treatment S_1V_3 and the lowest was in (0.33 and 0.67) treatment S_3V_2 in the growing seasons of 2014-15 and 2015-16. In 2016-17 it was found to be statistically non-significant. At 30 DAS treatments S_2V_1 and S_3V_1 produced the maximum branches plant⁻¹ (3.00, 2.67 and 2.67) whereas the minimum branches plant⁻¹ (0.67) was produced by treatments S_3V_2 and S_3V_4 in all three growing seasons. At 40 DAS the highest branches plant⁻¹ (6.33, 6.33 and 6.00) was found in the treatment S_1V_1 whereas the lowest branches plant⁻¹ (2.00 and 1.67) was observed in S_1V_2 , S_1V_4 , S_2V_2 , S_2V_4 and S_3V_2 in the growing season of 2014-2015, 2015-2016 and 2016-2017. At maturity of mustard, in the growing seasons of 2014-2015, 2015-2016 and 2016-2017 the maximum branches plant⁻¹ (12.00, 11.33 and 10.67) were found in treatments S_2V_1 which were significantly different from all other treatments. Any other way hand, the minimum branches plant⁻¹ (3.00) was observed in treatments S_2V_3 , S_2V_4 and S_3V_4 .

The combined effect of sowing time and variety on days to 50% flowering of mustard was recorded in the different growing seasons. The maximum days required for 50% flowering (42.67) of mustard was observed in treatment S_1V_1 and the lowest days (26.33) were found in S_2V_1 . In 2nd and 3rd growing seasons days required for 50% flowering found highest (42.00 and 41.33) in treatments S_1V_2 and S_2V_2 and the lowest days (27.33 and 28.00) was found in treatments S_2V_1 and S_3V_1 . Combined effect of sowing time and variety on days required to maturity of mustard was observed significant. In the growing season of 2014-15 the maximum days required (104.70) for days to maturity in treatment S_2V_2 whereas the minimum days (75.33) was found in S_1V_1 . Treatments S_3V_2 and S_1V_2 required the higher days for days to maturity (102.70 and 103.00) and treatment S_2V_2 required lowest days (74.67 and 72.64) in 2nd and 3rd growing seasons.

Pod length of mustard was significantly influenced by sowing time and variety. In the growing season of 2014-15, the maximum pod length (5.00) was found in treatment S_2V_4 and the lowest pod length (3.85) was found in treatment S_2V_3 . In 2nd and 3rd growing seasons pod length found statistically non-significant.

In the three different growing seasons the maximum number of pods plant⁻¹ (130.00, 125.00 and 132.20) was observed in treatment S_2V_2 and the minimum number of pods plant⁻¹ (60.00, 48.82 and 64.13) was found in treatments S_3V_1 .

There were found significant effect of sowing time and variety on number of seeds pod⁻¹ of mustard in the growing seasons of 2014-15, 2015-16 and 2016-17. Treatment S_1V_3 originated the maximum number of seeds pod⁻¹ (27.00, 28.05 and 29.00) whereas the minimum number of seeds pod⁻¹

(10.00, 9.66 and 9.66) were found in treatment S_2V_2 in all the three growing seasons.

The combined effect of sowing time and variety on number of seeds plant⁻¹ of mustard in three different growing seasons was found significant. Treatment S_2V_3 produced the highest number of seeds plant⁻¹ (2000.00, 1990.00 and 2046.00) whereas treatment S_3V_2 gave the lowest number of seeds plant⁻¹ (1000.00, 950.50 and 990.00) in both the growing seasons of 2014-15, 2015-16 and 2016-17.

1000-seeds weight of mustard significantly influenced by the combined effect of sowing time and variety. In all three growing seasons the maximum 1000-seeds weight (2.90, 2.93 and 2.90 g) were observed in treatment S_2V_2 whereas the lowest 1000- seeds weight (2.33, 2.27 and 2.27 g) were found in treatment S_3V_1 in all three growing seasons.

Seed yield significantly influenced by the combined effect of sowing time and variety. The highest seed yield (1800.00 kg ha⁻¹) of mustard was observed in treatment S_2V_2 whereas the lowest seed yield (980.00 kg ha⁻¹) was found in treatment S_3V_1 in the growing season of 2014-15. In the growing seasons of 2015-16 and 2016-17, treatment S_2V_2 produced the maximum seed yield (1800.00 and 1815.00 kg ha⁻¹) and treatment S_3V_1 gave the lowest (880.80 and 880.00 kg ha⁻¹) seed yield.

The combined effect of sowing time and variety significantly influenced the straw yield of mustard. In the growing season of 2014-15 treatment S_1V_2 produced the highest straw yield (2300.00 kg ha⁻¹) and treatment S_3V_4 gave the lowest (1800.00 kg ha⁻¹) seed yield. In the growing seasons of 2015-16 and 2016-17 the maximum straw yield (230.00 and 2399.00 kg ha⁻¹) were observed in treatment S_2V_2 whereas the lowest straw yield (1700.00 and 1780.00 kg ha⁻¹) were found in treatment S_1V_4 and S_3V_4 .

The oil yield of mustard was influenced significantly by the combined effect of sowing time and variety. In the growing season of 2014-15 oil yield was statistically non-significant. Treatment S_3V_2 produced the highest oil yield (315.00 kg ha⁻¹) followed by S_2V_3 and S_3V_1 whereas the lowest oil yield was found (280.0 kg ha⁻¹) in treatments S_1V_3 and S_2V_4 in the growing season of 2015-16. In the growing season of 2016-17, treatment S_3V_2 produced the maximum oil yield (340.20 kg ha⁻¹) and treatment S_2V_4 gave the lowest oil yield (285.00 kg ha⁻¹).

After the above two experiments yield gap of mustard found between research field and farmer's field in the growing seasons of 2014-15, 2015-16 and 2016-17 were analyzed, find out the causes of yield gap and make strategies for minimizing the gaps. Under the growing season of 2014-2015 the yield gaps among different treatments were 280.00, 80.00, 350.00, 520.00, 290.00, 395.00, 698.00, 353.00, 290.00, 380.00, 305.00 and 310.00 kg ha⁻¹ respectively and in the % were 21.87, 4.42, 24.14, 33.12, 22.31, 17.99, 38.39, 22.09, 22.83, 20.00, 21.40 and 20.67 respectively. In the growing season of 2015-2016 the yield gaps were 400.00, 400.00, 425.00, 410.00, 360.00, 480.00, 470.00, 435.00, 329.20, 510.00, 430.00 and 436.00 kg ha⁻¹ and in the % were 30.74, 19.06, 29.82, 26.79, 27.48, 21.05, 31.54, 27.44, 27.21, 24.17, 30.07 and 28.38 respectively. From the growing season of 2016-2017 the yield gaps were 419.70, 447.00, 470.00, 430.00, 426.00, 471.00, 440.00, 594.00, 400.00, 520.00, 405.00 and 429.00 kg ha⁻¹ and in % were 31.79, 20.72, 31.54, 27.21, 30.96, 20.60, 29.04, 37.10, 31.25, 24.76, 27.45, 27.60 and 95.00 respectively. The highest yield of mustard 2195.00 kg ha⁻¹ was observed in research field and 1800.00 kg ha⁻¹ was in farmer's field with a yield gap of 39.00 kg ha⁻¹ and 17.99 % from the treatment S_2V_2 (10th November sowing time with variety BARI Sarisha 11) in the growing season of 2014-15. In

the growing season of 2015-16, the maximum yield of mustard 2280.00 kg ha⁻¹ was found in research field and 1800.00 kg ha⁻¹ was in farmer's field with a yield gap of 480.00 kg ha⁻¹ and 21.05% from the treatment S₂V₂ (10th November sowing time with variety BARI Sarisha 11). The treatment S₂V₂ also produced the highest yield of mustard 2286.00 kg ha⁻¹ in research field and 1815.00 kg ha⁻¹ was in farmer's field with a yield gap of 471.00 kg ha⁻¹ and 20.60% in the growing season of 2016-2017.

Several factors can cause yield gaps in mustards. In general, Biological factors, Socio-economic factors, Climatic factors, Institutional/government policy related factors and Factors promoting technology transfer are considered the factors that causing yields gaps in mustard.

For minimizing the yield gaps of mustard the following strategies can be taken: Improvement of integrated crop management, Adequate input and credit supplies, Research and extension support and Policy support.

REFERENCES

- Aggarwal, P. K. 2008. Impact of climate change on Indian agriculture: impacts, adaptation and mitigation. *Ind. J. Agric. Sci.* **78**: 911–919.
- Aggarwal, P. K., Hebbar, K. B., Venugopalan, M. V., Rani, S., Bala, A., Biswal, A. and Wani, S. P. 2008. Quantification of yield gaps in rain fed rice, wheat, cotton and mustard in India. ICRISAT. Global theme on Agro-ecosystems report P 43.
- Ahmed, F., Karim, M. R. and Jahan, M. A. 1999. Effect of different Management practices on the productivity and profitability of mustard under late sown condition. *Bangladesh J. Agril. Res.* **211 (3)**: 425-430.
- Ahmed, M. S. M. Eltas and Ahmed, J. 1988. Results of farm level socio-economic study on mustard production. *Bangladesh J. Agril. Res.* **13(1)**: 20.
- Akbar, A. 2011. Adoption of Modern Rapeseed Mustard and Sesame Varieties with Production Technology for Yield Gap Reduction. Bangladesh Agricultural Research Institute (BARI), Gazipur.
- Alam, M. 2006. Factors affecting yield gap and efficiency in rice productions in some selected areas of Bangladesh. A thesis submitted for the degree of Ph. D. Dept. of Economics, Jahangir Nagar University, Bangladesh.
- Alam, M. J., Ahmed, K. S., Mollah, M. R. A., Tareq, M. Z. and Alam, J. 2015. Effect of planting dates on the yield of mustard seed. *Int J Appl Sci Biotechnol*, **3(4)**: 651-654.
- Alam, M. M. and Rahman, M. M. 2006. Effect of row spacing on seed yield of five varieties of Rapeseed, *Bangladesh J. Crop Sci.* **17(1)**: 163-168.
- Ali, M. H. and Rahman, M. A. 1986. Response of nitrogen in TS-72(Kalayana) cultivar of *Brassica campestris*. *Bangladesh J. Agril. Res.* **11(3)**: 83-86.

- Allen, E. J. and Morgen, D. G. 1972. A quantitative analysis of growth and yield variation of rape and mustard. *J. Agric. Sci. Camb.* **103**: 249-252.
- Angadi, S. V., Culforch, H. W., McConkey, B. C. and Gan, Y. 2003. Yield adjustment by canola growth at different plant population under semi-arid conditions. *Crop Sci.* **43**: 1358-1366.
- Angrej, S., Dhingra, K. K., Jagroop, S. and Singh, M. P., 2002. Effect of sowing time and plant density on growth, yield and quality of Ethiopian mustard (*Brassica carinata* L. Br.) *J. Res.* **39(4)**: 471-475.
- Anil Kumar, Bikram Singh, Yashai and Yadav, J. S. 2004. Effect of sowing time and crop geometry on tetra locular Indian mustard under southwest Haryana. *Ind. J. Agric.Sci.* **74(11)**: 594-596.
- Anonymous, 2006. Bangladesh Bureau of Statistics. Monthly Statistical Bulletin of Bangladesh. January, Statistics Div., Ministry of Planning, Govt. People's Repub. Bangladesh. 54.
- Ansari, A. H., Quayyum, S. M., Mirza, A. A. and Chaudhury, N. A. 1990. Effect of different sowing dates on the growth and yield of three varieties of mustard. *Pakistan J. Agric. Res.* **11 (4)**: 234-248.
- AOAC. 1975. *Official Methods of Analysis* (12th Edition), William Sterwetzed, Published by AOAC. Washington, DC. pp. 506-508.
- Asgari, A. S. and Moradi-Dalyny, A. 2008. Evaluation of yield, yield components and vegetative characteristics on different planting date of canola in Haji Abad Hormozgan. *Plant and Seed.* **23**: 419-430.
- Awasthi, U. D., Singh, R. B. and Dubey, S. D. 2007. Effect of sowing date and moisture conservation practice on growth and yield of Indian mustard (*Brassica juncea*) varieties. *Indian J. Agron.* **52(3)**:151-153.
- BARC.1989. Fertilizer recommendation guide. The Bangladesh Agriculture Research Council, Farm gate, Dhaka, pp.86.
- BARI. 1992. Annual Report 1992-93. Bangladesh Agricultural Research Institute, Joydebpur, Gazipur. pp. 231-298.
- BARI. 2000. Krishiprojecti, Handbook of Agro-technology.2nd Eden., Bangladesh Agril. Res. Inst., Joydeppur, Gazipur.

- BARI. 2001. Annual report for 2000-2001. Oilseed Research Centre. Bangladesh Agril. Res. Inst., Joydebpur, Gazipur.
- Basak, N. C., Pandit, J. C. and Khurram, M. M. H. 2007. On-farm evaluation of three mustard varieties under different fertilizer packages. *Bangladesh J. Sci. Ind. Res.* **42(3)**: 335-340.
- BBS. 1992. Statistical Yearbook of Bangladesh Bureau of Statistics. Statistics Division, Ministry of Planning, Govt. Peoples Republic of Bangladesh. pp. 145-172.
- Begum, F. 2005. Effect of seed rate and row spacing on the yield and yield components of two varieties of mustard. M. S. Thesis, Dept. Agron., Bangladesh Agril. Univ., Mymensingh. P.22.
- Berea, N. 1999. Influence of sowing time on some winter oilseed rape genotype in the Moldavian Forest Steppe. II. Productivity aspects. *Problem –de-Agrofitotehnic-Teoretica-si-Alpicata.* **21(1-2)**:47-62.
- Bhagat, D. V. and Singh, S. 1987. Effect of date of sowing and varieties on seed quality, yield aphid infestation on mustard. *Bhartiya Krishi Anusandhan Patrika.* **4**:179-183.
- Bhargava, S. C. 1991. Physiology of Indian oilseed (*Brassica*) in Indian Agriculture. Har-Ananda Publications and Vikas Publish Pvt. Ltd. pp.161-197.
- Bhargava, S. C. and Tomar, D. P. S. 1982. Physiological basis of yield improvement in rapeseed and mustard. Indo Swedish joint workshop on rapeseed and mustard. PP.33-41.
- Bhuiyan, M. R. 1989. Techniques of multiplication of pulse and oilseeds. Pulse and oilseeds techniques of Bangladesh. (Ed. Huda, N and Hussain, M.). BADC. PP. 98-103.
- BINA. 2004. Annual Report 2003-2004, Bangladesh Inst. of Nucl. Agriculture, Mymensingh. P. 53.
- Bishnoi, K. C. and Kanwar S. 1979. Oil yield and quality parameters of three raya varieties as affected by sowing time and nitrogen levels. *Ind. J. Agron.* **24(3)**: 255-263.

- Brar, N. S., Bakhetia, D. R. C. and Sekhon, B. S. 1987. Estimation of losses in yield of rapeseed and mustard due to mustard aphid, *Lipaphis erysimi* (Kalt.). *Journal of Oilseeds Research*, **4**: 261-64.
- Brar, Z. S., Bal, D. S. and John, A. S. 1998. Influence of sowing dates, nitrogen and planting geometry on the performance of Gonhi Sarson (*Brassica napus* spp. Oleifera var. annua). *Indian J. Agron.* **43 (1)**:133-137.
- Bryan, K. H., Eric, D. E., Robert, H., Patrick, M. C. and Kent, R. M. 2001. Seeding Rate Response to various management factors in Canola production. *North Dakota Agric. Ext. Annual Report*. P. 29.
- Bukhtiar, B. A., Atta, M. and Habib, G. 1992. Effect of sowing dates on seed yield of rapeseed and mustard under rain fed condition. *J. Agric. Res.* **30(4)**:463-469.
- Butter, G. S. and Aulakh, C. S. 1999. Effect of sowing date, nitrogen and row spacing on growth, yield attributes and yield of Indian mustard (*Brassica juncea*). *Indian J. Agron.* **44(4)**:813-815.
- Chakraborty, P. K., Majumder, A. and Chatterjee, B. N. 1991. Physiological processes in Indian mustard (*Brassica juncea*) Yellow sarson (*Brassica napus*) and their agronomic application in mild and short winter prevailing in Gangetic plains of eastern India. *Indian J. Agril. Sci.* **61(11)**:851-861.
- Chandrakar, B. L. and Urkurkar, J. S. 1993. Performance of mustard varieties to dates of sowing in rice fallow. *Ind. J. Agron.* **38 (1)**: 143-144.
- Chaudhury, N., Singh, H., Faroda, A. S. and Singh, H. 1988. Effect of varying soil moisture regime on seed yield, water use and water use efficiency of some Indian mustard (*B. juncea*) genotypes. *Transac. Indian Soc. Desert Technol.* pp. 33-40.
- Chauhan, A. K., Mahak S. and Dadhwal, K. S. 1984. Effect of nitrogen level and row spacing on the performance of rapeseed (*Brassica napus*). *Ind. J. Agron.* **37(4)**: 851-853.

- Chay, P. and Thurling, N. 1989. Variation in pod length in spring rape (*Brassica napus*) and its effect on seed yield and yield components. *J. Agril. Sci.* **113(2)**:139-147.
- Chen, C., Jackson, G., Heill, K., Wichman, D., Johnson, G. and Johnson, D. 2005. Determining the feasibility of early seeding canola in the Northern Great Plains. *Agron. J.* **97**: 1252-1262.
- Choudhary, J. K. and Thakuria, R. K. 1994. Response of Indian mustard (*Brassica juncea*) and toria (*Brassica campestris*) to sowing date under rain fed conditions. *Ind. J. Agron.* **39 (4)**: 687-688.
- Clarke, J. M., Clarke, F. R. and Simpson, G. M. 1978. Effects of method and rate of seeding on yield of *Brassica napus*. *Can. J. Plant Sci.* **58**: 549-550.
- Das, M. L., Malek, M. A. and Rahman, A. 1998. Performance of gamma irradiated M₅ mutants of rapeseed in different location of Bangladesh. *Bangladesh J. Agric.* **24(1)**:115-119.
- Das, T. K. 1998. Studies on the performance of some new mustard genotypes under irrigated conditions. *J. Oilseeds Res.* **15(2)**: 310-314.
- Degenhardt, D. F. and Kondra, Z. P. 1981. The influence of seeding date and seeding rate on seed yield and growth characters of five genotypes of *Brassica napus*. *J. Plant Sci.* **61**:185-190.
- Diepenbrock, W. 2000. Yield analysis of winter oilseed rape (*Brassica napus* L.): a review, *Field Crops Research*, **67**: 35–49.
- El-Nakhlawy, F. S. and Bakhashwain, A. A. 2009. Performance of Canola (*Brassica napas* L.) seed yield, yield components and seed quality under the effects of four genotypes and nitrogen fertilizer rates. *JKAU: Met., Env. & Arid Land Agric. Sci.* **20(2)**: 33-47.
- FAO (Food and agricultural Organization) 2007. FAO Production year Book. Rome, Italy, Vol. 61. p.64.
- FAO. (Food and Agriculture Organization). 2011. [http:// faostat. fao. org/ site/567/default.aspx](http://faostat.fao.org/site/567/default.aspx). Food and agricultural Organization of the United Nations. Vol. 38. p.48.

- Faraji, A. 2004. Effect of row spacing and seed rate on yield and yield components of rapeseed. *Seed and Plant*, **20**:297-314.
- Fashami, M. Z., Delkhosh, B., Shirani Rad, A. H. and Noor mohammadi, G. 2012. Turnip rape yield and yield components response to different sowing dates under different irrigation regimes. *African Journal of Agricultural Research*, **7(19)**:2983-2988.
- Gaffer, M. A. and Mohammad, H. 1988. Effect of different seed rates at different management levels on the performance of mustard. *Bangladesh J. Sci. Ind. Res.* **23**:62-66.
- Ghanbahadur, M. R., Linear, B. K., Shinde, V. S. and Patil, S. M. 2005. Effect of sowing dates, irrigation levels and mulching on growth and yield of Indian mustard. *Ann. Plant Physio.* **19(1)**:49-55.
- Ghosh, M. R. 1993. *Aphid Ba Jabpoka*. West Bengal State Book Board, Kolkata, PP. 175
- Ghosh, R. K. and Chatterjee, B. N. 1988. Effect of dates of sowing on oil content and fatty acid profiles of Indian mustard. *Indian J. Oilseed Res.* **5(2)**: 144-149.
- Gomez, K. A. and Gomez, A. A. 1984. Statistical Procedure for Agricultural Research. 2nd Ed. A. John Wiley Interscl. Pub. PP 130-240.
- Halva, S., Hirvi, T., Makinen, S. and Honkanen, E. 1986. Yield and glycosylates in mustard seed and volatile oils in caraway seeds and coriander fruit yield and glycosylate contents of mustard seed. *J. Agril. Sci.* **58(4)**:157-162.
- Hanson, B. K., Johnson, B. L., Henson, R. A. and Riveland, N. R. 2008. Seeding rate, seeding depth and cultivar influence on spring canola performance in the Northern Great Plains. *Agron. J.* **100(5)**:1339-1346.
- Hanson, H., Borlaug, E. and Anderson, R. G. 1982. Narrowing the yield gap: Wheat in the Third World. Boulder, Colorado (USA), West View Press. p. 127-133.

- Hasan, M. M. 2005. Effect of seed rate and hormone on growth and yield of mustard. M. S. Thesis, Dept. Crop. Bot., Bangladesh Agril. Univ., Mymensingh. P. 20.
- Hocking, P. J. and Stapper, M. 2001. Effect of sowing time and nitrogen fertilizer on Canola and wheat, and nitrogen fertilizer on Indian mustard. I. Dry matter production, grain yield and yield components. *Australian J. Agril. Res.* **52(6)**:623-634.
- Hossain, M. A., Arabinda, S. and Abedin, M. J. 1984. Effect of seed rate and time of sowing on the yield of mustard under rain fed condition. *Bangladesh J. Agril. Res.* **9**: 54-57.
- Hossain, M. A., Jahiruddin, M. and Khatun, F. 1995. Response of wheat and mustard to manganese, zinc and boron in Calcareous Soil. *Bangladesh J. Crop Sci.* **6(1&2)**: 51-56.
- Hossain, M. A., Zahiruddin, M. and Khatun, F. 2012. Effect of Boron on yield and mineral nutrition of mustard (*Brassica napus*). *Bangladesh J. Agril. Res.* **36(1)**:63-73.
- Hossain, M. B., Alam, M. S. and Ripon, M. A. 2013. Effect Of Irrigation And Sowing Method On Yield and Yield Attributes Of Mustard. *Rajshahi University Journal of Life & Earth and Agricultural Sciences*, **41**:65-70.
- Hundal, S. S., Prabhjyot, K. and Malikpuri, S. D. S. 2004. Radiation use efficiency of mustard cultivars under different sowing dates. *J. Agromet.* **6(1)**:70-75.
- Hussain, M. F. and Kumar, R. 2006. Influence of sowing dates and application of zinc on the performance of mustard in South-West semi-arid zone of Uttar Pradesh. *Int. J. Agril. Sci.* **2(2)**:601-604.
- Hussain, M. F., Zakaria, A. K. M. and Jahan, M. H. 1996. Technical report on variety screening, Adaptive research on oilseeds. Rural Development Academy. PP. 6-34.
- Hussain, S., Hazarika, G. N. and Barura, P. K. 1998. Genetic variability, Heritability and Genetic Advanced in Indian Rapeseed (*B. campestris*). *Bangladesh J. Agril. Res.* **8**: 43-47.

- Islam, M. B. 2005. Requirement of boron for mustard, wheat, and chickpea based rice cropping patterns. Ph.D. Dissertation, Department of Soil Sci. Bangladesh Agricultural University, Mymensingh.
- Islam, N., Choudhury, M. and Karim, M. R. 1994. Effects on sowing date on growth and development of mustard and rapeseed. *Progress. Agric.* **59**:23-29.
- Jahan, M. H. and Zakaria, A. K. M. 1997. Growth and yield performance of different varieties of rapeseed, mustard and caola in level Barind Trac. *Progress. Agric.* **8 (1&2)**:144-152.
- Jahan, S. 2005. Effect of seed rate and sulphur level on the yield and yield components of mustard. M. S. Thesis, Dept. Agron., Bangladesh Agril. Univ., Mymensingh. P. 23.
- Jain, V. K., Chauhan, Y. S., Khandekar, M. P. and Jain, P. C. 1989. Effect of sowing dates and genotypes on yield and yield attributing trials in Indian mustard. *Madras J. Agric.* **76(5)**: 241-246.
- Jan, Y., Ahmad, B., Fahad, S., Samad, N., Ziaullah, Ayesha, Ali, N., Anjum, M. M., Sohail, M. and Anjum. 2017. Evaluation of *Brassica* varieties as affected by various sowing methods in Peshawar valley. *Int J Environ Sci Nat Res.* **2(4)**: 010-0107.
- Jenkins, P. D. and Leitch, M. H. 1986. Effects of sowing date on the growth and yield of winter oil seed rape (*Brassica napus* L.). *Journal of Agriculture Science, UK*, **107(2)**: 405 - 420.
- Johnson, B. L., McKay, K. R., Schneider, A. A., Hanson, B. K. and Schatz, B. G. 1995. Influence of planting date on canola and crambe production. *Jour of Prod Agric.* **8**: 594-599.
- Johnson, L. B., Patrick, M. C., Ericksmon, E. D., Bryan, E. H. and Nild, R. 2001. New Canola production Practices. Challenge Research to Provide Defined Techniques to producers, Annual Report. Dickinson Research Extension Cent. pp. 55-60.
- Kandil, A. A. 1983. Effect on sowing date on yield, yield components and some agronomic characters of oilseed rape (*Brassica napus* L.). In: 6th Intl. Rapeseed Conf. Paris, France, p.297.

- Karim, M. R., Islam, F., Ahmed, F. and Islam, M. R. 2000. Performance of some *B. juncea* varieties under on farm condition at Pabna. *Bangladesh J. Agril. Extn.* **27(1)**:157-158.
- Kaur, R., Setia, N. and Setia, R. C. 2006. Influence of delayed sowing and kinetin on growth and yield components of Indian mustard (*B. juncea*). *Environment and Ecology*, **24**: 872-875.
- Keerthi, P., Pannu, R. K., Dhaka, A. K. and Ashoka Reddy, Y. 2017. Yield attributes, yield and quality of Indian mustard (*Brassica juncea* L.) as influenced by dates of sowing and nitrogen levels in Western Haryana. *International Journal of Chemical Studies*, **5(6)**: 1890-1893.
- Khajepour, M. R. 2001. Principals and Essentials of crop Production. Jihad-University Press. Isfahan University, pp. 201.
- Khaleque, M. A. 1983. Agricultural Research in Bangladesh. A Monograph of Bangladesh Agricultural Research Council. Farm gate, Dhaka, Bangladesh. p. 51.
- Khaleque, M. A. 1989. A Guide book on the production of oilseeds in Bangladesh. Dept. Agril. Extn. PP. 24-26.
- Khan, A., Arif, M., Shah, A., Ali, S. and Hussain, Z. 2007. Evaluation of planting methods for grain yield and yield components of wheat. *Sarhad. J. Agric.* **23(3)**.
- Khan, M. J., Khattak, R. A. and khan, M. A. 2000. Influence of sowing methods on the productivity of canola grown in saline field. *Pak. J. Biological Sci.* **3(4)**: 687-691.
- Khan, M. N. and Tak, G. M. 2002. Performance of different growth duration varieties of mustard under different date of sowing and spacing. *Ann. Agril. Res.* **23(3)**:430-436.
- Khan, R. U. and Muendel, H. H. 1999. Influence of topping rapeseed on yield components and other agronomic characters under varying dates of planting. *Pakistan Journal of Botany*, **26**:167- 171.

- Kiresur, V. R., Ramanna, R. and Hedge, D. M. 2001. Improved technologies in oil seeds production. An assessment of their economic potentials in India. *Agricultural Economic Research Review*, **14(2)**:95-108.
- Kondra, Z. P. 1977. Effect of planted seed size and seeding rate on rapeseed. *Can. J. Plant Sci.* **57**:277-280.
- Kumar, A., Singh, B., Yashpal and Yadava, J. S. 2004. Effect of sowing time and crop geometry on tetra ocular Indian mustard (*Brassica juncea*) under south west Haryana. *Indian J. Agril. Res.* **74 (11)**:594-596.
- Kumar, A., Kumar, S., Rai, S. and Kant, S. 2015. Effect of Different N Level with and Without P and K on Physico-Chemical Properties of Soil under Mustard Crop. *Environment & Ecology*, **33 (1A)**:331-336.
- Kurmi, K. 2002. Influence of sowing date on the performance of rapeseed and mustard varieties under rain fed situation of Southern Assam. *J. Oilseeds Res.* **19(2)**: 197-198.
- Kurmi, K. and Kalita, M. M. 1992. Effect of sowing date, seed rate and method of sowing on growth, yield and oil content of rapeseed (*Brassica juncea*). *Ind. J. Agron.* **37(3)**:595-597.
- Laskar, N., Mandal, J. and Ghosh, S. K. 2004. Effect of temperature on the incidence of mustard aphid, *lipaphis erysimi* Kalt. on broccoli both in open and covered conditions in the Hills of Darjeeling. *Environment and Ecology*, **22**: 342-44.
- Laxminarayana, P. and Poornachand. 2000. Response of mustard varieties to time of sowing in Northern Telangana. *J. Res. ANGRAU*, **28(1&2)**: 75-77.
- Leach, J. E., Stevenson, R. and Mullen, A. J. 1999. Effects of high plant populations on the growth and yield of winter oilseed rape (*Brassica napus*). *Journal Agriculture Science.* **132**: 173–180.
- Lutman, P. J. W. and Duxon, F. L. 1987. The effect of drilling date on the growth and yield of oilseed rape (*Brassica napus* L.). *J. Agric. Sci. Camb.* **108**:195-200.

- Majumdar, D. K. and Sandhu, A. S. 1964. Effect of time of sowing and fertilizer on the growth, development, quality character, Sties and chemical composition of rapeseed. *Indian Oilseed J.* **8**:169-276.
- Mamun, F., Ali, M. H. and Chowdhury, I. F. 2014. Performance of rapeseed and mustard varieties grown under different plant density. *Sci Agri.* **4(2)**:70–75.
- Matharu, K. S. and Tanwar, P. S. 2019. Yield gap analysis of rapeseed-mustard in context of *Lipaphis erysimi* (Kalt). *Journal of Entomology and Zoology Studies*, **7(4)**: 1306-1309.
- Matin, M. A. AnwarulHup, A. S. M. Hussain, M. S., Karim, M. R. and Baksh, E. 1996. Farm level yield analysis of tomato cultivation in selected areas of Bangladesh. An economic profile. *Bangladesh J. Agric. Res.* **21(1)**:1208-1213.
- Mattigatti, R., Veerabhadrapa, B. P. and Renukarya, C. K. 2009. Yield gap in sericulture in Karnataka-An economic analysis. *Karnataka J. Agric. Sci.* **22(5)**:1046-1050.
- McVetty, P. B. E., Scarth, R. and Rimmer, S. R. 1988. Agronomic studies in hybrid spring canola rapeseed Congress. *Indian J. Agron.* **15(3)**:253-258.
- Meena, B. L., Meena, R. P., Meena, R. H. and Balai, C. M. 2012. Yield gap analysis of rapeseed-mustard through front line demonstrations in agro climatic zone Iva of Rajasthan. *Journal of oilseed Brassica.* **3(1)**:51-55.
- Mendham, N. J., Russell, J. and Jaros, N. K. 1990. Response to sowing factors of oilseed rape. *Rosliny Oleiste.* **17**: 223-234.
- Mendham, N. J., Shipway, P. A. and Scott. R. K. 1981. The effect of delayed sowing and weather on growth development and yield of winter oilseed rape (*Brassica napus* L.). *Journal of Agric. Sci. Camb.* **96**: 389-416.
- Mendham, N. N., Russel, J. and Jarosz, N. k. 1990. Response to sowing time of three contrasting Australian cultivars of oilseed rape (*Brassica napus*). *J. Agric. Sci. Camb.* **114 (3)**: 275-283.

- Mendhan. M. J. and Scoot, R. K. 1975. The limiting effect of plant size at inflorescence initiation on subsequent growth and yield of oilseed rape (*Brassica napus*). *J. Agric. Sci (Camb)*. **84**:487-502.
- Mengel, K. and Kirkby, E. A. 1987. Principle of plant nutrition. International Potash Institute, Switzerland. p.471-475.
- Miah, M. N. H., Karim, M. A., Rahman, M. S., Rahman, A. and Islam, M. A. 1987. Effect of seed rate and method of sowing on the yield and yield components of rapeseed (*Brassica campestris*). *Bangladesh J. Nucl. Agric.* **3**:53-57.
- Mir, M. R., Mobin, M., Khan, N. A., Bhat, M. A., Lone, N. A., Bhat, K. A., Razvi, S. M., Wani, S. A., Wani, N., Akhter, S., Rashid, S., Masoodi, N. H. and Payne, W. A. 2010. Effect of fertilizers on yield characteristics of mustard (*Brassica juncea* L. Czern&Coss). *Journal of Phytology*. **2(10)**: 20-24.
- Mishra, B. K. and Rana, N. S. 1992, Response of yellow sarson (*Brassica napus* var.) glaucal to row spacing and nitrogen fertilization under late sown condition. *Ind. J. Agron.* **37(4)**: 847-848.
- Mondal, M. R. and Wahab, M. A. 2001. Production Technology of oilseeds. Oilseed Res. Centre, Bangladesh Agril. Res. Inst. Joydebpur, Gazipur. PP. 6-24.
- Mondal, M. R. I. and Islam, M. A. 1993. Effect of seed rate and date on yield and yield performance of rapeseed. *Bangladesh J. Agril. Sci.* **20 (1)**:29-33.
- Mondal, M. R., Biswas, M., Hydar-Ali, M. K. and Akbar, M. A. 1999. Response of rapeseed genotype Dhali to seed rate and seeding date. *Bangladesh J. Agril. Res.* **24 (1)**:83-90.
- Mondal, M. R., Islam, M. A. and Khaleque, M. A. 1992. Effect of variety and planting date on the yield performance of mustard and rapeseed. *Bangladesh J. Agril. Sci.* **19 (92)**:181-188.
- Mondal, S. S., Das, S. K., Pradhan, B. K. and Goswami, S. B. 1990. Effect of potassium on the growth and yield of mustard at varying plants density. *J. Potas. Res.* **6(3)**:119-123.

- Myers, L. R. 1995. Uses of Canola. Canola, Inc. 8910 Purdue Road, Suite 150, Indianapolis, IN **46**: 268.
- Naseralla, A. Y. 2000. Effect of seeding rate on growth and quality characteristics of two species of *Brassica*. *The Iraqi Journal of Agricultural Science*, **31(2)**: 273-282 (in Arabic).
- Nath, D. K. 1982. Review on control of mustard aphid, *Lipaphiserysimi* (Kaltb.) (Aphididae: Homoptera) in India, pp 207-213. In *Pulses and Oilseeds in West Bengal* (Ed Mukherji DK) Directorate of Agriculture, Government of West Bengal, Writers' Buildings, Kolkata, pp. 223.
- Nigussie, A., Adefris, T. and Zerihum, T. 1996. Effect of agronomic practices on seed and oil yields of Ethiopian mustard (*Brassica carinata* A. Braun) and rapeseed (*Brassica napus* L.) *Trop. Agric.* **73(2)**: 94-99.
- Panda, B. B., Bandyopadhyay, S. K. and Shivay, Y. S. 2004. Effect of irrigation level, sowing dates and varieties on yield attributes, yield consumptive water use and water- use efficiency of Indian mustard (*Brassica juncea*). *Indian J. Agric. Sci.* **74(6)**:339-342.
- Pandey B. P., Sirvastava, S. K. and Lal, R. S. 1981. Genotype and environment interaction in lentil. *LENS*. **8**: 14-17.
- Panwar, K. S., Sharma, S. K. and Nanwal, R. K. 2000. Influence of sowing time on the yield of different mustard cultivars (*Brassica* sp.) under conserved soil moisture conditions. *Indian J. Agric. Sci.* **70(6)**:398-399.
- Patel, R. H., Meisheri, T. G. and Patel, J. R. 1998. Yields, nutrient content and uptake by Indian mustard (*Brassica juncea*) Czernj and Cossonj as influenced by FYM, nitrogen of fertilizer. *Gujarat. Agr. Univ/ Res. J.* **23:(2)**: 1-8.
- Piri, I., Nik, M. M., Tavassoli, A., Rastegaripour, F. and Babaeian, M. 2011. Effect of irrigation frequency and application levels of sulfur fertilizer on water use efficiency and yield of Indian mustard (*Brassica juncea*). *African Journal of Biotechnology*. **10 (55)**: 11459-11467.

- Pooran, C., Govardhan, M. and Sumatra, M. 2000. Effect of dates of sowing on performance of mustard varieties. *Gaurav Society of Agril. Res. Infor. Cent. India*. **1(2)**:153-155.
- Prasad, R. P., Mandal, R. K., Shahi, B. and Barun. 2020. Yield gap analysis of Rapeseed-Mustard through Cluster Front Line demonstrations in Siwan district of Bihar, India. *Int. J. Curr. Microbiol. App. Sci.* **9(5)**: 922-928.
- Rahman, L. and Kuddus, M. A. 1988. Experimental yield trial with three *Brassica juncea* lines against Shambal. *Brassica Breeding Programme, IORP*. **17**:21-22.
- Rahman, M. M. 2002. Status of oil seeds and future prospects in Bangladesh. Paper presented in Review Workshop on the Impact of Technology Transfer on Oil Crops, held at BARI on 29 April, 2002.
- Rahman, M. M., Hossain, S. M. A., Islam, N., Jalaluddin, M. and Salam, M. U. 1993. Effect of sowing date and boron fertilizer on the yield and oil content of mustard and rapeseed. *Bangladesh J. Agric.* **15(1&2)**: 73-78.
- Raj, S., Patidar, M. and Singh, B. 2001. Response of Indian mustard cultivars to different sowing time. *Ind. J. Agron.* **46(2)**: 292-295.
- Raj, S., Rao, V. U. M., Diwan, S. and Surakant. 2002. Effect of sowing date and plant density on phenological behavior, yield and its attributes in oilseed *Brassica*. *J. Oilseeds Res.* **19(1)**:119-121.
- Rajendra, K. and Shaktawat, M. J. 1992. Effect of limited water supply, nitrogen and time of sowing on production of rapeseed (*Brassica napus*). *Ind. J. Agron.* **37(4)**:853-855.
- Rana, D. S. and Pachauri, D. K. 2001. Sensitivity of zero erucic acid genotypes of *Oleiferous Brassica* to plant population and planting geometry. *Ind. J. Agron.* **46(4)**:736-740.
- RAP (Regional Office for Asia and the Pacific). 1999. Report of the expert consultation on bridging rice yield gap in the Asia- Pacific region. FAO.

- Raquibullah, S. M., Begum, F., Mondal, M. R. I., Kader, M. A. and Amin, M. R. 2006. Performance of rapeseed-mustard genotype under early, optimum and late sowing conditions. *Bangladesh J. Agric. Res.* **2(3)**:1-7.
- Rashid, M. H., Hasan, M. M., Ahmed, M., Rahman, M. T. and Rahman, K. A. M. M. 2012. Response of mustard to boron fertilization. *Bangladesh, j. Agril. Res.* **37(4)**:677-682.
- Razzaque, M. A., Idris Ali Howlader, M., Rafiquzzaman, S., Ahsanullah, M. and NizamUddin, M. 2002. Effect of time of sowing on the performance of mustard varieties in the southern region of Bangladesh. *Bangladesh J. Agril. Res.* **27(3)**:479-484.
- Reddy, M. D. and Avilkumar, K. 1997. Effect of dates of sowing on performance of mustard varieties in non-traditional areas of Andhra Pradesh. *J. Oilseeds Res.* **14(2)**:207-209.
- Reta-Sanches, G. D. and Fowler, J. L. 2002. Canopy light environment and yield of narrow-row cotton as affected by architecture. *Agronomy Journal.* **94**:1317-1323.
- Rhaman, M. M., Salam, M. U., Miah, M. G. and Islam, M. S. 1988. Effect of sowing time on the performance of mustard (SS-75). *Bangladesh J. Agric. Res.* **13(1)**:47-51.
- Roy, Indrajit. 1997. Stagnating productivity in crop agriculture. The quest for sources of growth. Environment and agricultural productivity in Bangladesh. *Bangladesh Academy of Agriculture (BAAG)*. P. 270-274.
- Saha, P. K., Saleque, M. A., Zaman, S. K. and Bhuiyan, N. J. 2003. Response of mustard to S, Zn, and B in Calcareous Soil. *Bangladesh J. Agril. Res.* **28(4)**:633-636.
- Saran, G. and Giri, G. 1987. Influence of dates of sowing on *Brassica* species under semi-arid rain fed conditions of North-West India. *J. Agric Sci. Camb.* **108**:561-566.
- Sariev, N. A. 1983. Mechanize production of mustard. *Oil Cultures*, **5**:11-12 (RU).

- Sarkees, N. A. 2013. Response of growth, yield and oil of rapeseed to sowing method and seeding rate. *Journal of Agriculture and Veterinary Science*. **3(1)**:1-6.
- Scott, R. K., Ogunremi, E. A., Ivins, J. D. and Mendham, N. J. 1973. The effect of sowing date and season on growth and yield of oilseed rape (*Brassica napus*). *J. Agric. Sci. Camb.* **81**:277-285.
- Shah, A. S. and Rahman, K. 2009. Yield and growth response of rapeseed (*Brassica napus* L.) mutants to different seeding rates and sowing dates. *Pak. J. Bot.* **41(6)**: 2711-2716.
- Shahidullah, M., Islam, U., Karim, M. A. and Hussian, M. 1997. Effect of sowing dates and varieties on yield and yield attributes of mustard. *Bangladesh J. Sci. and Industrial Res.***5**:11-14.
- Shahin, Y. and Valiollah, R. 2009. Effects of row spacing and seeding rates on some agronomical traits of spring canola (*Brassica napus* L.) cultivars. *Central European of J. Agriculture*, **10(1)**:115-122.
- Shamsuddin, A. K. M. and Rahman, L. 1977. Studies on the performance of some exotic and indigenous varieties of mustard under Bangladesh conditions. *Bangladesh J. Agril. Res.* **3**:1-8.
- Sharaan, A. N. and Gowad, K. I. A. 1986. Effect of cultivars and seeding rate on forage yield and crude protein in rape (*B. napus* L.). *Ann. Agril. Sci.* **24(4)**:1857-1870.
- Sharief, A. F. and Kheshta, M. M. 2002. Influence of sowing dates and plant density on growth and yield of canola (*Brassica napus* L.) under salt affected soils in Egypt. *Scientific Journal of king Faisal University*. **3(1)**:45-78.
- Sharma, H. M. and Kumar, G. 2006. Effect of date and planting systems on yield and economics of chickpea+ mustard intercropping system. *Indian pulses Res. Inst., Kanpur, India.* **19(2)**:253-254.
- Sharma, M. L., 1992, Response of mustard (*Brassica juncea*) varieties to row spacing. *Ind. J. Agron.* **37(3)**: 593-514.

- Sharma, S. K., Mendhe, S. N., Kolte, H. S., Rajput, G. R. and yenpreddiwar, M. D. 2006. Effect of sowing and irrigation management on growth and yield of mustard (*Brassica juncea*). *J. Soils and Crops*. **16(2)**:455-459.
- Shivani and Sanjeev, K. 2002. Response of Indian mustard (*Brassica juncea*) to sowing date and row spacing in mid hills of Sikkim under rain fed conditions. *Ind. J. Agron.***47(3)**: 405-410.
- Shrief, S. A., Shavana, R., Ibrahim, A. T. and Geisler, G. 1990. Variation in seed yield and quality characters of four spring oil rapeseed cultivars as influenced by population arrangements and densities. *J. Agron. and Crop Sci.***165(2-3)**:103-109.
- Siddiq, E. A. 2000. Bridging rice yield gap in India. In: Proceedings of Expert Conference on bridging the rice yield gap in the Asia-Pacific region, RAP, FAO.
- Sidlauskas, S. A. and Bemotas, S. 2003. Some factors affecting seed yield of spring oilseed rape (*Brassica napus L.*). *Agronomy Research*, **1(1)**: 229-243.
- Singh, C. P. and Sachan, G. C. 1994. Assessment of yield losses in yellow sarson due to mustard aphid, *Lipaphiserysimi* (Kalt). *Journal of Oilseeds Research*. **11(2)**: 179-184.
- Singh, H. 2001. Effect of row spacing and nitrogen doses on nutrient uptake and oil yield in mustard. *Crop Res.* PP. 431-435.
- Singh, H. V., Meena, M. K., Choudhary, R. L., Dotaniya, M. L., Meena, M. D., Jat, R. S., Premi, O. P. and Rai, P. K. 2019. Effect of Direct Sowing and Transplanting on Yield Performance of Indian mustard. *Int. J. Curr. Microbiol. App. Sci.* **8(2)**: 509-515.
- Singh, K. and Singh, D. 1987. Response of mustard to nitrogen and spacing. *Indian J. Agron.* **32(1)**: 15-17.
- Singh, K. B., Singh, P., Bhola, A. L and Yadava, T. P. 1972. Effect of sowing and nitrogen application in varieties of Indian mustard (*Brassica Juncea L. Czern & Coss*) under irrigated condition in Haryana. *Indian J. Agric. Sci.***42**:601-603.

- Singh, R. K., Kumar, H. and Singh, A. K. 2010. Brassica based intercropping systems- a review. *Agri. Review*, **31(4)**: 253 - 266.
- Singh, R., Rao, V. and Singh, D. 2001. Relationship of yield and yield attributes with physiological traits in brassicaceae. *Indian Journal of Agricultural Sciences*. **70(9)**: 581-583.
- Singh, S. K. and Ghanshyam Singh. 2002. Response of Indian mustard (*Brassica juncea*) varieties to nitrogen under varying sowing dates in eastern Uttar Pradesh. *Ind. J. Agron.* **47(2)**: 242-248.
- Singh, S. N., Singh, V. K., Singh, R. K. and Singh, K. R. 2007. Evaluation of on-farm front line demonstrations on the yield of mustard in Central Plains Zone of Uttar Pradesh. *Indian Res. J. Ext. Edu.* **7(2&3)**:79-81.
- Starner, D. E., Hamama, A. A. and Bhardwaj, L.1999. Canola oil yield and quality as affected by production practices in Virginia, ASHS Press Alexandria, 254–256.
- Sugawe, G. T. and Shelke, V. B. 1997. Response of mustard to various levels of irrigation and nitrogen. *J. Maharashtra Agr. Univ.* **22(3)**: 316-317.
- Suleimenova, M. Sh. 2000. Photosynthetic activity and productivity of irrigated crops. In: *The Problems of Stabilization and Development of Agriculture in Kazakhstan, Siberia and Mongolia*. Almaty, 20 October 2000. pp.79-80 (Ru).
- Sultana, N.A., Khan, M.A.H., Isla, M.N. and Hasanuzzaman, M. 2009. Integrated management of aphid (*Lipaphis erysimi* Kalt.) in mustard. *World J. Zool.* **4(2)**: 105–108.
- Surekha, E. and Reddy, R. G. 1996. Performance of mustard varieties under different dates of sowing. *J. Oilseeds Res.* **13(1)**: 70-73.
- Takar, B. L. and Jat, K. L. 2005. Effect of dates of sowing on the incidence of aphid (*Lipaphis erysimi* Kalt) on mustard (*Brassica juncea* Linn.). *Crop Res.* **29(1)**:145-147.

- Taylor, A. J., and Smith, G. J. 1992. Effect of sowing date and seeding rate on yield and yield components of irrigated canola (*Brassica napus* L.) grown on a red-brown earth in South-Eastern Australia. *Aust. J. Agric. Res.* **43**: 1629-1641.
- Thakur, K. S. and Singh, C. M. 1998, Performance of *Brassica* species under different dates of sowing in mid hills of Himachal Pradesh. *Ind. J. Agron.* **43(3)**: 464-468.
- Thakur, K. S., 1999. Response of promising varieties of Indian mustard (*Brassica juncea*) to nitrogen and spacing under mid hills, rainfed conditions of Himachal Pradesh. *Ind. J. Agron.*, **44(4)**: 816-819.
- Thurling, N. 1974. Morph physiological determinates of yield in rape seed (*B. campestris* and *B. napus*). Yield components, *Aust. J. Agric. Res.* **25**: 714-721.
- Thurling. N. 1974a. Morph physiological determinates of field in rape seed (*B. campestris* and *B. Napus*). Growth and morphological characters. *Aust. J. Agric. Res.* **25**:697-710.
- Tyo, T. O. and Morgan, D. G. 1979. Factors influencing flowers and pod development in oilseed rape (*Brassica napus* L.). *J. Agric. Sci.* **92**: 363-373.
- Uddin, M. M., Samad, A., Khan, M. R., Begum, S., Hussain, K. and Khaleda, S. 1987. Variety x sowing date interaction in mustard and rapeseed. *Bangladesh J. Agril. Res.* **12(2)**:55 -60.
- Vasi, M., Arvind, K. and Ras Togi, A. K. 1986. Effect of sowing dates on rape seed varieties. *Ind. J. Agron.* **21(1)**:1-4.
- Vassilina, T., umbetov, A. and vassilina, G. 2012. Some aspects of mineral and organic nutrition for improved yield and oil contents of mustard (*Brassica juncea*). *Bulgarian Journal of Agricultural Science*, **18(6)**: 924-928.
- Verma, H. and Dawson, Joy. 2018. Yield and Economics of Mustard (*Brassica compestris* L.) as Influenced by Sowing Methods and Levels of Sulphur and Boron. *Int. J. Curr. Microbiol. App. Sci.* **7(1)**: 380-386.

- Wahhab, M. A., Mondal, M. R. I., Akbar, M. A., Alam, M. S., Ahmed, M. U. and Begum, F. 2002. Status of oil seed crops production in Bangladesh. Oil Seed Res. Center, Bangladesh Agril. Res. Inst., Joydebpur, Gazipur. pp. 4-62.
- Walkowshi, T. 2001. Influence of sowing date and sowing rate on the yields of spring rapeseed varieties: open pollinated variety Star and composite hybrid Margo. *Rosliny, Oleisite*. **22(2)**:409-422.
- Yadav, H. K., Thomas, T. and Khajuria, V. 2010. Effect of different levels of sulphur and biofertilizer on the yield of Indian mustard (*Brassica juncea* L.) and soil properties. *Journal of Agricultural Physics*. **10**:61-65.
- Yadav, R. N., Suraj Bhan and Uttam, S. K. 1994a. Yield and moisture use efficiency of mustard in relation to sowing date, variety and spacing in rain fed lands of central Uttara Pradesh. *Ind. J. Soil Cons.* **22(3)**:29-32.
- Yadav, R. N., Suraj Bhan and Uttam, S. K. 1994b. Effect of sowing variety and plant population on growth and yield of rain fed Indian mustard (*Brassica juncea*). *Ind. J. Agron.* **39(4)**: 682-684.
- Yadava, T. P., Yadava, A. K. and Singh, A. 1978. A concept of plant ideotype, in Indian mustard (*Brassica juncea*). International rapeseed conference. PP. 322-325.
- Yaseen, M., Zahir Aziz, M., Komal, A. and Naveed, M. 2017. Management of textile wastewater for improving growth and yield of field mustard (*Brassica campestris* L.). *International journal of phytoremediation*. **19(9)**: 798–804.
- Zaman, S. M., Rahman, L. and Niah, M. A. J. 1991. Effect of date of sowing on the performance of mustard under zero tillage condition. *Bangladesh J. Agric. Sci.* **18(2)**: 199-202.
- Zekatte, V. 1999. Dependence of white mustard crops on sowing time and rate on light soils. *Zemdirbyste Mokslo Darbai*, **66**: 116-123.

APPENDICES

Appendix Table 1. Physical and chemical properties of soil of the experimental field.

Sl. No	Particulars	Values		Method employed
I.	Physical properties (%)			Hydrometer method
1.	Textural composition			(Piper, 1966)
a.	Coarse sand	9.30		
b.	Fine sand	16.30		
c.	Silt	11.50		
d.	Clay	62.90		
e.	Soil texture	Clay loam		
2.	Bulk density (Mg/m ³)	1.30	Core sampler method	Core sampler method (Dastane, 1967)
II.	Chemical properties	Value	Rating	
1.	pH (1:2.5 soil: water suspension)	7.6	Neutral	Potentiometric method (Piper, 1966)
2.	Available nitrogen (kg/ha)	209	Medium	Alkaline permanganate method (Subbaiah and Asija, 1956)
3.	Available phosphorus (P ₂ O ₅) (kg ha ⁻¹)	30	medium	Olsen's method (Jackson, 1967)
4.	Available potassium (K ₂ O) (kg ha ⁻¹)	338	medium	Flame photometer method (Jackson, 1967)
5.	Organic carbon	0.52	Medium	Walkley and Black wet oxidation method (Jackson, 1967)

Appendix Table 2. Monthly average meteorological report of the study area during the growing season of 2013-2014.

Month	Rainfall (mm)	Temperature (°C)		Relative humidity (%)
		maximum	Minimum	
April	070	35.5	24.1	70
May	430	33.3	25.2	80
June	271	33.9	27.1	86
July	312	32.8	26.7	90
August	482	32.6	26.3	87
September	208	33.3	26.3	86
October	280	31.6	24.4	85
November	000	30.4	18.2	76
December	000	27.0	15.0	79
January	000	24.0	12.6	82
February	024	27.7	15.2	75
March	005	32.9	20.1	69
Total average	2082	375.0	261.2	965

Appendix Table 3. Monthly average meteorological report of the study area during the growing season of 2014-2015.

Month	Rainfall (mm)	Temperature (°C)		Relative humidity (%)
		maximum	Minimum	
April	050	37.7	25.1	65
May	118	36.8	26.6	74
June	440	33.8	26.4	84
July	394	32.8	26.9	86
August	258	33.0	26.7	86
September	205	33.3	26.2	85
October	010	33.1	24.0	80
November	000	31.0	18.4	78
December	000	25.6	14.2	82
January	041	25.3	13.8	81
February	035	29.3	16.6	76
March	028	32.8	19.7	70
Total average	131.583	32.041	22.050	78.917

Appendix Table 4. Monthly average meteorological report of the study area during the growing season of 2015-2016.

Month	Rainfall (mm)	Temperature (0C)		Relative humidity (%)
		maximum	Minimum	
April	107	34.2	23.9	77
May	128	36.0	26.7	77
June	318	33.5	26.8	84
July	924	31.6	25.9	91
August	371	32.6	26.7	87
September	293	33.3	26.2	86
October	083	33.1	24.3	82
November	003	30.8	20.3	81
December	006	26.3	16.6	85
January	000	25.8	13.5	80
February	009	30.5	19.4	78
March	005	33.9	22.6	75
Total average	187.250	31.800	22.742	81.917

Appendix Table 5. Monthly average meteorological report of the study area during the growing season of 2016-2017.

Month	Rainfall (mm)	Temperature (°C)		Relative humidity (%)
		Maximum	Minimum	
April	058	36.3	26.7	75
May	350	35.1	25.3	78
June	353	33.8	26.5	85
July	413	32.2	26.5	88
August	643	33.0	26.5	86
September	147	34.0	26.4	84
October	081	33.4	24.8	82
November	075	29.9	19.4	81
December	000	27.1	15.5	83
January	000	26.2	13.0	78
February	002	29.6	16.6	74
March	059	31.7	20.7	75
Total average	181.750	31.858	22.325	80.750



Appendix Plate 1. Researcher showing seeds in the experimental field and tagging the Indent Plants.



Appendix Plate 2. Researcher with his supervisor and co-supervisor and farmer is weeding in the farmer's field.



Appendix Plate 3. Researcher observed the plant growth in the farmer's Field.



Appendix Plate 4. Researcher with his Supervisor & Team Members of Rajshahi University and Researcher observed the harvesting time.



BARI Sarisha 9



BARI Sarisha 11



BARI Sarisha 14



BARI Sarisha 15

Appendix Plate 5. Seeds with pods of different varieties of mustard used in this study.

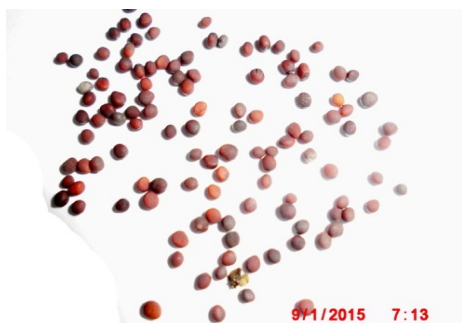

BARI Sarisha 9

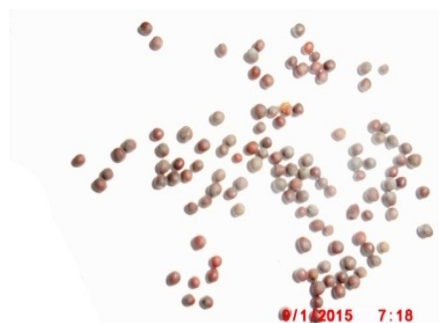

BARI Sarisha 11



BARI Sarisha 14



BARI Sarisha 15

Appendix Plate 6. Seeds of different varieties of mustard used in this study.